

LECTURE NOTES

For Environmental Health Science Students

Air Pollution



**Ethiopia Public Health
Training Initiative**

Mengesha Admassu,
Mamo Wubeshet

University of Gondar

In collaboration with the Ethiopia Public Health Training Initiative, The Carter Center,
the Ethiopia Ministry of Health, and the Ethiopia Ministry of Education

August 2006



Funded under USAID Cooperative Agreement No. 663-A-00-00-0358-00.

Produced in collaboration with the Ethiopia Public Health Training Initiative, The Carter Center, the Ethiopia Ministry of Health, and the Ethiopia Ministry of Education.

Important Guidelines for Printing and Photocopying

Limited permission is granted free of charge to print or photocopy all pages of this publication for educational, not-for-profit use by health care workers, students or faculty. All copies must retain all author credits and copyright notices included in the original document. Under no circumstances is it permissible to sell or distribute on a commercial basis, or to claim authorship of, copies of material reproduced from this publication.

© 2005 by Mengesha Admassu, Mamo Wubeshet

All rights reserved. Except as expressly provided above, no part of this publication may be reproduced or transmitted in any form or by any means, electronic or mechanical, including photocopying, recording, or by any information storage and retrieval system, without written permission of the author or authors.

This material is intended for educational use only by practicing health care workers or students and faculty in a health care field.

PREFACE

Shortage of appropriate textbooks that could meet the need for training professionals on the nature and the magnitude of ambient and indoor air pollutions and their effects have been one of the outstanding problems in the existing higher health learning institutions in Ethiopia. Therefore, a well-developed teaching material to produce the required qualified health professionals, who are considered to shoulder the responsibility of preventing and controlling of air pollutions by creating awareness and entertaining some interventional measures among the communities, is obvious.

The present lecture note on “Air pollution” is therefore, prepared to be used as a teaching material to train mainly environmental health and other students of health category in Ethiopia. It is believed this teaching material plays a significant role to solve the critical shortage of reference books and text on the subject. The lecture note is designed to make the training somehow a practical application to the actual indoor and out door air pollutions in the country. It contains five chapters in which the major current out/ in-door air pollution problems with their suggested solutions are discussed. Each chapter is presented in simple language and is provided with learning objectives, body introduction, exercises, and suggested reading as appropriate. Text books,

journals, internet sources and other lecture manuscript are used to develop this lecture material.

We have also incorporated the useful ideas of different instructors of the course to standardize it to its present status, which the authors hope to further improve the draft through the consultations, pretest and revisions. It is also hoped that this lecture note will be of particular use not only for students of health category in colleges and universities, but to those graduates working in health care service institutions and environmental protection agencies.

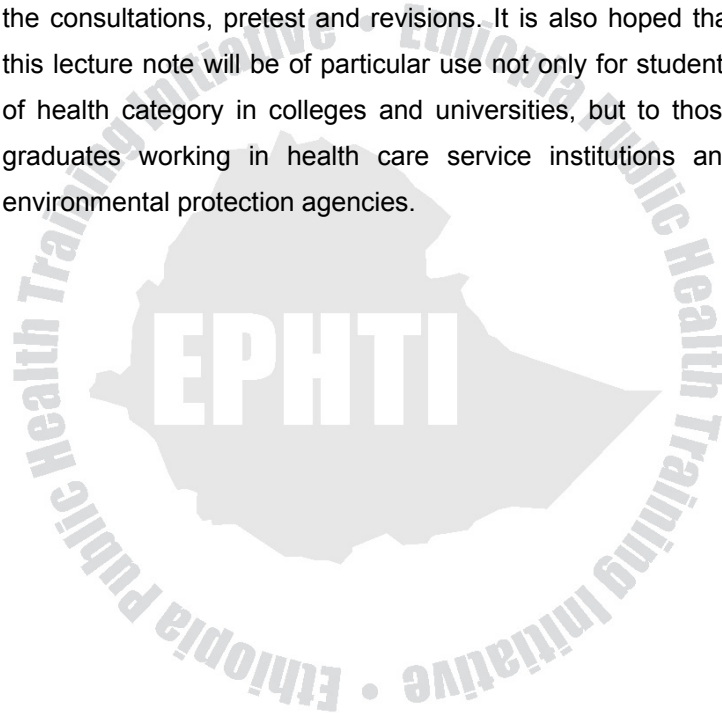

ACKNOWLEDGEMENTS

We would like to express our thanks to The Carter Center, Atlanta Georgia, for financial supports to the subsequent workshops conducted to develop the lecture note.

The Carter Center would also be acknowledged for providing useful guidelines, technical and moral support during the development of the lecture note. All the instructors, who teach the courses in the existing higher teaching-learning institutions, who critically reviewed the manuscript on subsequent mini-workshops, are acknowledged.

Finally, we thank all the individuals who have in some ways contributed to this lecture note, either in conversations with us or through reviewing the draft.

Table Contents

Preface	i
Acknowledgements	iii
Table of content	iv
List of Tables	viii
List of figures/boxes	ix
Abbreviation	x
CHAPTER ONE: Introduction	1
1.1. Learning Objective	1
1.2. Introduction to the course	1
1.3. Historical Overview	8
1.4. Definition of terms and scale conversion	10
1.5. Energy Transfer	14
1.6. Public Health importance of Air Pollution	15
1.7. Exercise question	17
CHAPTER TWO: Meteorology and Air Pollution	18
2.1. Learning Objective	18
2.2. Introduction to the chapter	18
2.3. Temperature Lapse rate and stability	21
2.4. Wind velocity and turbulence	32
2.5. Plume behavior	34
2.6. The Gaussian Plume Model	37
2.7. Estimation of Plume rise	42

CHAPTER THREE: Sources, Types of Air Pollutants	
and Their Effects.....	46
3.1 Learning Objective.....	46
3.2 Introduction to the Chapter.....	46
3.3 Common condition to which air pollution exposure may contribute.....	47
3.4 Types of Air Pollutants.....	49
3.4.1. Conventional Air Pollutants	49
3.4.2. Non Conventional Air Pollutants	62
3.5. Magnitude and source of ambient air pollution	78
3.6. Exercise question	83
CHAPTER FOUR: Industrial Air Pollution	84
4.1 Learning Objective.....	84
4.2 Introduction to the Chapter	84
4.3 Types of Industrial Air Pollutants	85
4.4 Air Pollution from Industrial Accidents	87
4.5 Air Pollution in the Workplace	90
4.6. Exercise question	92
CHAPTER FIVE: Global Environmental Problems	
Due to Air Pollution	93
5.1. Learning Objective.....	93
5.2. Introduction to the Chapter.....	93
5.3. Global warming (Green house effect)	94
5.4. Ozone depletion	97
5.5. Acid Rain	100

5.6. Exercise question	106
CHAPTER SIX: Indoor Air Pollution	107
6.1. Learning Objective.....	107
6.2. Introduction to the Chapter.....	107
6.3. Environmental tobacco smoke	109
6.4. Radon gas	110
6.5. Formaldehyde	113
6.6. Asbestos	114
6.7. Lead.....	114
6.8. Carbon Monoxide	115
6.9. Biological Contaminants	119
6.10. Building materials, furniture's and chemical products.....	120
6.11. Sick Building Syndrome (SBS).....	120
6.12. Indoor air pollution in relation to developing countries	124
6.13. Exercise questions	135
CHAPTER SEVEN: Risk Assessment.....	136
7.1 Learning Objective.....	136
7.2 Introduction to the Chapter.....	136
7.3 The health risk assessment and risk management framework	137
7.4. Epidemiological methods.....	139
7.5. Hazard identification in the field	153

7.6. The relationship between dose and health outcome	155
7.7. Human exposure assessment	157
7.8. Health risk characterization	171
7.9. Health in environmental impact assessment (EIA)	172
7.10. Exercise question	176
CHAPTER EIGHT: Sampling and Analysis	177
8.1 Learning Objective.....	177
8.2 Introduction to the Chapter	177
8.3 Ambient Air Quality Standards and Guidelines	178
8.4 Exercise question	184
CHAPTER NINE: Air Pollution Prevention and Control	185
9.1. Learning Objective.....	185
9.2. Introduction to the Chapter	185
9.3. Control of Ambient Air Pollution	187
9.4. Exercise question	195
REFERENCES	196
APPENDIX	199
1. Weather- man wind measuring reports system	
2. Some questions worth asking about fuel, cooking and ventilation	
3. Indoor air sampling procedure	
4. Composition of clean dry Atmospheric air	

List of Tables

1. Examples of common conditions to which air exposure may contribute	48
2. Potential Human effects of Nitrogen Dioxide	55
3. Major types of occupational pulmonary disease	81
4. Common air pollutants, their sources and pathological effects on man	82
5. Types of air pollution by chemical characteristics and source	86
6. Predicted carboxyl hemoglobin levels for subjects engaged in Different types of work	116
7. Human Health effects associated with Low-Level carbon monoxide exposure: Lowest-observed-adverse-effect level	118
8. Sources of pollutant Emissions in the United States 1959	122
9. Relative contribution of different emissions and respective pollutants in Sao Paulo. Brazil	179
10. Air quality standards, United States, 1989	181
11. WHO Air quality guidelines for Europe, Revised 1994	182

List of Figures/boxes

Figures

1. Deaths in London Administration country and the outer ring by weeks 53
2. Range of particles diameters from Airborne Dusts and fumes. 60
3. Deposition of dust particles by size 70

Boxes

1. London Fog 51
2. Bhopal – A case study of an International disaster 89
3. Motor vehicle Air pollution: Health effects and control strategies 197

ABBREVIATIONS

CNS	–	Central Nerve System
COHb	-	Carboxihemoglobine.
DALYS	–	Disability Adjusted Life Years
EPA	–	Environmental Protection Agency
EPHTI	-	Ethiopian Public Health Training Initiative
GCMHS	–	Gondar College of Medical and Health Sciences
IR	-	Infrared Radiation
LOAEL	–	Lowest –Observed – Adverse –Effect – Level
M.P.H.	–	Miles Per Hour
PM	–	Particulate Matter
TSM	–	Total Suspended Matter
TSP	–	Total Suspended Particulates
UOG	-	University of Gondar
UV	-	Ultra-Violet rays
VOC	-	Volatile Organic Compounds

CHAPTER ONE

INTRODUCTION

1.1. Learning Objective

After the completion of this chapter, the student will be able to:

1. Describe the importance of Air as the basic health requirement of human life
2. Define what air pollution means and other related terms
3. Enumerate different types of air pollutants
4. List physical forms of pollutants

1.2. Introduction to the course

Air is essential for life itself; without it we could survive only a few minutes. It constitutes immediate physical environment of living organisms. It is a mixture of various gases like nitrogen, oxygen and carbon dioxide, and others in traces; along with water vapor perceptible as humidity and suspended solids in particulate form.

The atmosphere is layered into four distinct zones of contrasting temperature due to differential absorption of solar energy. The four atmospheric layers are: Troposphere, stratosphere, mesosphere, and thermosphere. Understanding

how these layers differ and what creates them helps us understand atmospheric function.

TROPOSPHERE

The layer of air immediately adjacent to the earth's surface is called the troposphere. Ranging in depth from about 16 km (10 mile) over the equator to about 8 km over the poles, this zone is where most weather events occur. Due to the force of gravity and the compressibility of gases, the troposphere contains about 80% of the total mass of the atmosphere. Air temperature drops rapidly with increasing altitude in this layer, reaching about -60°C at the top of the troposphere. A sudden reversal of this temperature gradient creates a sharp boundary, the tropopause, that limits mixing between the troposphere and the upper zones.

Other characteristics of troposphere

- All life activities occur in this zone
- Contains water vapor, gases and dust
- The residence time of particle in the troposphere is short due to rain (ppt), gravity, air movement
- Mixing time is rapid due to wind or turbulence

STRATOSPHERE

The stratosphere extends from the tropopause up to about 50 km. Air temperature in this zone is stable or even increases with higher altitude. Although more dilute than the

troposphere, the stratosphere has a very similar composition except two important components: water and ozone. The fractional volume of water vapor is about one hundred times lower, and ozone is nearly one thousand times higher than in the troposphere. Ozone is produced by lightning and irradiation of oxygen molecules and would not be present if photosynthetic organisms were not releasing oxygen. Ozone protects life on the earth surface by absorbing most incoming solar ultra violet radiation.

Recently discovered decreases in stratospheric ozone over the Antarctica (and to a lesser extent over the whole planet) are of a serious concern if these trends continue, we would be exposed to increasing amount of dangerous UV rays, resulting in:

- Higher rate of skin cancer
- Problem with eyes (Cataract, conjunctivitis etc.)
- Genetic mutations
- Crop failures &
- Disruption of important living organisms

Other characteristics of stratosphere

- Contain no water vapor and dust
- Amount of ozone vary depending on location and season of the year. Ozone concentration are lowest above the equator, increasing towards the poles, they also increased markedly between autumn and spring

- Mixing time is lower
- Pollution entering in this region tends to remain long time due to low mixing

MESOSPHERE

Above the stratosphere, the temperature diminishes again creating the mesosphere, or the middle layer. The minimum temperature in this region is about -80°C.

THERMOSPHERE

At an altitude of 80 km, another abrupt temperature change occurs. This is the beginning of the thermosphere, a region of highly ionized gases, extending to about 1600 km. Temperatures are very high in the thermosphere because molecules there are constantly bombarded by high energy solar & cosmic radiation

The lower part of the thermosphere is called the **ionosphere**; this is where the **aurora borealis (northern lights)** appears when showers of solar or cosmic energy causes ionized gases to emit visible light. There is no sharp boundary that marks the end of the atmosphere. Pressure and density decreases gradually as one travels away from the earth until they become indistinguishable from the near vacuum of **interstellar space**. The composition of the thermosphere also gradually merges with that of interstellar space, being made up mostly of **He & H₂**.

The immediate concern of human beings is that the nature of air they breathe for oxygen and respiratory should always be access to human body. The thermal comfort experienced and the smell and hearing sense activated through the medium of air are of other area of health concern.

What is air Pollution?

Air pollution may be defined as any atmospheric condition in which certain substances are present in such concentrations that they can produce undesirable effects on man and his environment. These substances include gases (SO_x, NO_x, CO, HCs, etc) particulate matter (smoke, dust, fumes, aerosols) radioactive materials and many others. Most of these substances are naturally present in the atmosphere in low (background) concentrations and are usually considered to be harmless. The background concentrations of various components of dry air near sea level and their estimated residence times are given in Annex-1 Thus, a particular substance can be considered as an air pollutant only when its concentration is relatively high compared with the background value and causes adverse effects.

Air pollution is a problem of obvious importance in most of the world that affects human, plant and animal health. For example, there is good evidence that the health of 900 million urban people suffers daily because of high levels of ambient air sulfur dioxide concentrations. Air pollution is one of the

most serious environmental problems in societies at all level of economic development. Air pollution can also affect the properties of materials (such as rubber), visibility, and the quality of life in general. Industrial development has been associated with emission to air of large quantities of gaseous and particulate emissions from both industrial production and from burning fossil fuels for energy and transportation.

When technology was introduced to control air pollution by reducing emissions of particles, it was found that the gaseous emissions continued and caused problems of their own. Currently efforts to control both particulate and gaseous emissions have been partially successful in much of the developed world, but there is recent evidence that air pollution is a health risk even under these relatively favorable conditions.

In societies that are rapidly developing sufficient resources may not be invested in air pollution control because of other economic and social priorities. The rapid expansion of the industry in these countries has occurred at the same time as increasing traffic from automobiles and trucks, increasing demands for power for the home, and concentration of the population in large urban areas called mega cities. The result has been some of the worst air pollution problem in the world.

In many traditional societies, and societies where crude household energy sources are widely available, air pollution

is a serious problem because of inefficient and smoky fuels used to heat buildings and cook. This causes air pollution both out door and indoors. The result can be lung disease, eye problems, and increased risk of cancer.

The quality of air indoors is a problem also in many developed countries because buildings were built to be airtight and energy efficient. Chemicals produced by heating and cooling systems, smoking and evaporation from buildings materials accumulate indoors and create a pollution problem.

In Ethiopia, like many traditional societies, the problem of indoors air pollutions resulted from in efficient and smoky fuels used to heat buildings and cook. In the rural households of Ethiopia, most of the children and women are staying in overcrowded condition of a one roomed /thatched roof /*Tukul*/ house that exposed them for the indoor air pollution. It is also known that mothers and children are spending more than 75% percent of their day time at home.

Identification of the problems of both at out doors and indoors air pollutions in the societies one has to make interventions to alleviate the health related problems and promote safe ventilation of air in the living and working areas. First, however, some basic science is needed to understand air pollution.

1.3. Historical overview

Human have undoubtedly been coping with a certain amount of polluted air ever since primitive *Homo sapiens* sat crouched by the warmth of a smoky fire in his Paleolithic cave. An inevitable consequence of fuel combustion, air pollution mounted as a source of human discomfort as soon as man begins to live in towns and cities. It has become an extremely serious problem on the world wide basis during the past century for two primarily reasons:

1. There has been an enormous increase in world population, particularly in urban areas, and
2. The rapid growth of energy intensive industries and rising level of affluence in the developed countries has led to record levels of fossil fuel combustion

Prior to the 20th Century problems related to air pollution were primarily associated, in public mind at least, with city of London. As early as 18th Century small amount of coal from Newcastle were being shipped in London for fuel. As the population and the manufacturing enterprises grew, wood supplies diminished and coal burning increased, in spite of the protestation of a long series of both monarchs and private citizens who objected to the odor of coal smoke. One petitioner to king Charles II in 1661 complained that due to the greed of manufacturers, inhabitants of London were forced to “breath nothing but an impure and thick mist, accompanied by

a fuliginous (sooty) and filthy vapor, which render them obnoxious to a thousand in conveniences, corrupting the lungs, disordering the entire habit of their bodies.

In spite of such railings, English coal combustion increased even faster than the rate of population growth and by the 19th Century London's thick, "pear soup" fogs had become a notorious trade mark of the city, numerous well meaning attempts at smoke abatement were largely ignored during the hay day of laissez-faire capitalism, epitomized by the industrialists slogan "where there is muck there is money "

The same condition, which had made London air pollution capital of the world, began to prevail in the United States as well during the 19th and early 20th Century. St. Louis. Plagued by smoke condition. Passed an ordinance as early as 1867 mandating that smoke stacks be at least 20 ft higher than adjacent buildings The Chicago City council in 1881 passed the notion first smoke ordinance. Pittsburgh, once one of the smokiest cities in the US was the site of pioneer work at the Mellon In the harmful impact of smoke both on property and human health .In spite of gradually increasing public awareness of the problem, levels of air pollution and the geographical extent of the areas affected continued to increase. Although by the late 1950's and 1960's large scale fuel switching from coal to natural gas oil had significantly reduced smoke condition in many American cities, other

newer pollutants products of the new ubiquitous automobile had assumed worrisome level.

Today foul air has become a problem of global proportions; no longer does one have to travel to London or Pittsburg or Los Angeles to experience the respiratory irritation or the aesthetic distress. The contaminated atmosphere can provoke in the 1990's virtually every metropolitan area in the world New York, Rome Athens, Bombay, Tokyo, Mexico City capitalist and communities industrialized and developing nation alike are grappling with the problem of how to halt further deterioration air quality with out impending

1.4. Definition of terms and scale conversion

1.4.1. Air pollution: - concentration of foreign matter in air in excessive quantity which is harmful to the health of man.

1.4.2. Indoor air pollutions: - Pollutions from the housing made materials and living and working activities of the house, such as: natural radiation-radon, domestic combustion-coal gas, and human habits-tobacco smoking.

1.4.3. Out door air pollution: - Pollutions from out door services and environmental mixings, such as:

transportation-automobiles, industries-refineries, atomic energy plant-nuclear, and community activities-cleaning of streets.

- 1.4.4. Acute effects:** - within twenty four hours of sudden exposure to polluted air illness would occur.
- 1.4.5. Delayed effect:** - The cause and effect relationship of air pollution and chronic effects on health is in a way difficult to prove due to long time contact and accumulation effect.
- 1.4.6. Aerosols:** - Small solid or liquid particles (fine drops or droplets) that are suspended in air.
- 1.4.7. Dust:** - aerosols consist of particles in the solid phase.
- 1.4.8. Smoke:** - aerosols consist of particles in the solid- and sometimes also liquid-phase and the associated gases that result from combustion.
- 1.4.9. Ash:** - aerosols of the solid phase of smoke, particularly after it settles into a fine dust.
- 1.4.10. Particulates:** - Small particles, that travel in air and settle or land on something.
- 1.4.11. Fumes:** - are polydispersed fine aerosols consisting of solid particles that often aggregate together, so that many little particulates may form one big particle.

- 1.4.12. Inhalable fraction:** - Particles less than 100 μm that can be inhaled into the respiratory throat (trachea).
- 1.4.13. Thoracic fraction:** - Those particles below 20 μm , that can penetrate into the lungs.
- 1.4.14. Respirable range:** - the greatest penetration and retention of particles is in the range 10.0 to 0.1 μm .
- 1.4.15. Mist:** - A cloud or dense collection of droplets suspended in air.
- 1.4.16. Vapour:** - The evaporated compound in the gas phase.
- 1.4.17. Troposphere:** - The first and lowest of the atmospheric layers is called the "troposphere".
- 1.4.18. Stratosphere:** - The second layer of air is called the "stratosphere".
- 1.4.19. Ionosphere:** - Above the stratosphere is the "ionosphere" the top of which is the border line space.
- 1.4.20. Thermosphere:-** This is a region of highly ionized gases, extending to about 1600 km.
- 1.4.21. Mesosphere:** - Above the stratosphere, or the middle layer.
- 1.4.22. Wind:** - Is simply air in motion

Unit of measurement

Concentrations of air pollutants are commonly expressed as the mass of pollutant per Unit volume of air mixture, as mg/m^3 , $\mu\text{g}/\text{m}^3$, ng/m^3

Concentration of gaseous pollutants may also be expressed as volume of pollutant per million volumes of the air plus pollutant mixture (ppm) where $1\text{ppm} = 0.0001\%$ by volume. It is sometimes necessary to convert from volumetric units to mass per unit volume and vice versa.

The relation ship between ppm and mg/m^3 depends on the gas density, which in turn depends on:

- ❖ Temperature
- ❖ Pressure
- ❖ Molecular weight of the pollutant

The following expression can be uses to convert of between ppm and mg/m^3 at any temperature or pressure.

$$\text{mg}/\text{m}^3 = \frac{273 \times \text{PPM} \times \text{molecular wt.} \times \text{pressure}}{22.4 \times \text{temperature}}$$

Simply multiply the calculated value of mg/m^3 by 1000 to obtain $\mu\text{g}/\text{m}^3$

The constant 22.4 is the volume in liter occupied by 1 mole of an ideal gas at standard concentration (0°C and 1 atm.). One

mole of any substance is a quantity of that substance whose mass in grams numerically equals its molecular weight

1.5. Energy transfer in the atmosphere

The physical & chemical characteristics of the atmosphere and the critical heat balance of the earth are determined by energy and mass transfer processes in the atmosphere.

Incoming solar energy is largely in the visible region of the spectrum (400-700nm). The shorter wavelength blue solar light is scattered relatively more strongly by molecules and particles in the upper atmosphere, which is why the sky is blue as it is viewed by scattered light. Similarly, light that has been transmitted through scattering atmospheres appears red, particularly around the sun set and sun rise, and under circumstances in which the atmosphere contains a high level of particles.

Radiation from the sun arrives just outside the earth's atmosphere with average annual intensity; called the solar constant (isolation) S , currently equal about 1370 W/m^2 . If all this energy reached the earth's surface and was retained, the planet would have vaporized long ago

Some of the incoming solar energy that hits the earth is reflected back in to the space; such reflected energy is not absorbed by the earth or its atmosphere and does not contribute their heating. The fraction of incoming solar radiation that is a reflected is called *albedo*, and for the earth, the global annual mean value is now estimated to be about 31 percent.

1.6. Public Health importance of Air

1.6.1 Air pollution is a very complicated physical and chemical system. It can be thought of as a variety of constituents that are dissolved or suspended in air, many of which interact with one another and many of which acts together to produce their effects.

1.6.2 The constituents of air pollution change with the season, with industrial activity, with changes in traffic, and with the prevailing winds, to name just a few relevant factors. The composition of air pollution is, therefore, not constant from day to day or even week to week on an average, but trends to cycle. Average levels go up and down fairly consistently depending on the time of year but the actual levels are highly variable from one year to the next.

- 1.6.3 One of the most dangerous modes of transmission of health related problems is, air serves as a vehicle. Therefore poor ventilation of air and overcrowding conditions are creating more favorable situation to the transmission of pollutants.
- 1.6.4 In Ethiopia rural household conditions, where there are more family members, without having enough number of doors and windows and staying at home significant proportion of the day time are highly victims for indoor air pollutions.

1.7. Exercise question

Table 1.1: Exercise on the basic requirements for a healthy environment

Please make a rank according to their degree of importance to health

Using => +++++ Highly important
 +++ Moderately important
 ++ Important
 + Less important
 - No important

Parameter	Air	Water	Food	Settlement
Degree of importance				
Degree of accessibility				
Magnitude of health problem				
Risk of pollution at the Global level				
Risk of pollution at the National level				
Manageability level: - Globally - National - Households				
Preventive and control measures: - At policy - At community - At households				
Other parameters that need to be consider				

CHAPTER TWO

METEOROLOGY AND AIR POLLUTION

2.1. Learning objective

After the completion of this chapter, the student will be able to:

1. Describe the importance of metrology regarding to air pollution
2. Identify the importance of environmental and adiabatic laps rate
3. State the role of inversion on the concentration of air pollutants
4. Analyze plumes behavior in different environmental conditions

2.2. Introduction to the chapter

Meteorology specifies what happen to puff or plume of pollutants from the time it is emitted to the time it is detected at some other location. The motion of the air causes a dilution of air pollutant concentration and we would like to calculate how much dilution occurs as a function of the meteorology or atmospheric condition.

Air pollutants emitted from anthropogenic sources must first be transported and diluted in the atmosphere before these undergo various physical and photochemical transformation and ultimately reach their receptors. Otherwise, the pollutant concentrations reach dangerous level near the source of emission. Hence, it is important that we understand the natural processes that are responsible for their dispersion. The degree of stability of the atmosphere in turn depends on the rate of change of ambient temperature with altitude.

I. VERTICAL DISPERSION OF POLLUTANTS

As a parcel of air in the atmosphere rises, it experiences decreasing pressure and thus expands. This expansion lowers the temperature of the air parcel, and therefore the air cools as it rises. The rate at which dry air cools as it rises is called the dry adiabatic lapse rate and is independent of the ambient air temperature. The term adiabatic means that there is no heat exchange between the rising parcel of air under consideration and the surrounding air. The dry adiabatic lapse rate can be calculated from the first law of thermodynamics (1°C per 100m)

As the air parcel expands, it does work on the surroundings. Since the process is usually rapid, there is no heat transfer between the air parcel and the surrounding air.

Saturated adiabatic lapse rate, (Γ_s)

Unlike the dry adiabatic lapse rate, saturated adiabatic lapse rate is not a constant, since the amount of moisture that the air can hold before condensation begins is a function of temperature. A reasonable average value of the moist adiabatic lapse rate in the troposphere is about 6°C/Km.

Example

An air craft flying at an altitude of 9 km draws in fresh air at -40°C for cabin ventilation. If that fresh air is compressed to the pressure at sea level, would the air need to be heated or cooled if it is to be delivered to the cabin at 20°C.

Solution

As the air is compressed, it warms up it is even easier for the air to hold whatever moisture it may have, had .so there is no condensation to worry about and the dry adiabatic lapse rate can be used, At 10°C per km, compression will raise the air temperature by

$$10 \times 9 = 90^\circ\text{C} \text{ making it } -40 + 90^\circ\text{C} = 50^\circ\text{C}$$

It needs to be the air conditioned

The air in motion is called **wind**, air which is rushing from an area of high pressure towards an area of low pressure. When the weather-man reports the wind to us he uses a measuring system worked out in 1805 by Adoniral Beaufort. For

example, a “moderate breeze” is a wind of 13 to 18 miles an hour (see annex 2).

Obviously air quality at a given site varies tremendously from day to day, even though the emissions remain relatively constant. The determining factors have to do with the weather: how strong the winds are, what direction they are blowing, the temperature profile, how much sun light available to power photochemical reactions, and how long it has been since the last strong winds or precipitation were able to clear the air. Air quality is dependent on the dynamics of the atmosphere, the study of which is called *meteorology*

2.3. Temperature lapse rate and stability

The ease with which pollutants can disperse vertically into the atmosphere is largely determined by the rate of change of air temperature with altitude. For some temperature profiles the air is stable, that is, air at a given altitude has physical forces acting on it that make it want to remain at that elevation. Stable air discourages the dispersion and dilution of pollutants. For other temperature profiles, the air is unstable. In this case rapid vertical mixing takes place that encourages pollutant dispersal and increase air quality. Obviously, vertical stability of the atmosphere is an important factor that helps

determine the ability of the atmosphere to dilute emissions; hence, it is crucial to air quality.

Let us investigate the relationship between atmospheric stability and temperature. It is useful to imagine a “parcel” of air being made up of a number of air molecules with an imaginary boundary around them. If this parcel of air moves upward in the atmosphere, it will experience less pressure, causing it to expand and cool. On the other hand, if it moves downward, more pressure will compress the air and its temperature will increase.

As a starting point, we need a relationship that expresses an air parcel’s change of temperature as it moves up or down in the atmosphere. As it moves, we can imagine its temperature, pressure and volume changing, and we might imagine its surroundings adding or subtracting energy from the parcel. If we make small changes in these quantities, and apply both the ideal gas law and the first law of thermodynamics, it is relatively straightforward to derive the following expression.

$$dQ = C_p dT - V dP \dots\dots\dots (2.1)$$

Where: dQ = heat added to the parcel per unit mass (J/kg)

C_p = Specific heat at a constant pressure (1005 J/Kg-°C)

dT = Incremental temperature change (°C)

V = volume per unit mass (m³/kg)

dP = Incremental pressure change in the parcel (Pa)

Let us make the quite accurate assumption that as the parcel moves, there is no heat transferred across its boundary, that is, that this process is *adiabatic*

This means that $dQ = 0$; so we can rearrange (2.1) as

$$\frac{dT}{dT} = \frac{V}{Cp} \text{-----}(2.2)$$

The above equation gives us an indication of how atmospheric temperature would change with air pressure, but what are really interested in is how it changes with altitude .To do that we need to know how pressure and altitude are related.

Consider a static column of air with a cross section A, as shown in figure 2.1 .A horizontal slice of air in that column of thickness dZ and density ρ will have mass ρAdZ. If the pressure at the top of the slice due to the weight of air above it is P(Z+dZ), then the pressure at the bottom of the slice ,P(Z) will be P(z+dz)plus the added weight per unit area of the slice it self:

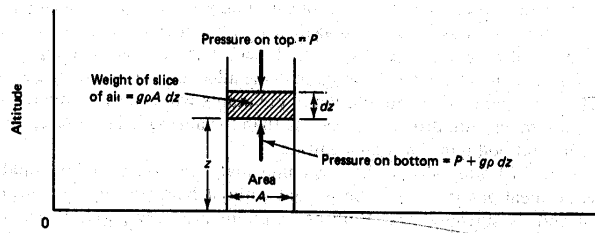

Figure 7.17 A column of air in static equilibrium used to determine the relationship between air pressure and altitude.

$$P(z) = P(z + dz) + \frac{g\rho A dz}{A} \text{-----} (2.3)$$

Where: g is the gravitational constant. We can write the incremental pressure dP for incremental change in elevation, dz as

$$dP = p(z+dz) - p(z) = -g\rho dz \text{.....} (2.4)$$

Expressing the rate of change in temperature with altitude as a product, and substituting in (2.2) and (2.3), gives

$$\frac{dT}{dZ} = \frac{dT}{dP} \times \frac{dP}{dZ} = \frac{V}{C_p} (-g\rho) \text{-----} (2.5)$$

However, since V is volume per unit mass and ρ is mass per unit volume, the product $V\rho=1$, and the expression simplifies to

$$\frac{dT}{dZ} = \frac{-g}{C_p} \text{-----} (2.6)$$

The negative sign indicates that temperature decreases with increasing altitude. Substituting the constant $g = 9.806\text{m/s}^2$, and the constant –volume specific heat of dry air at room temperature, $C_p 1005\text{J/kg. }^\circ\text{C}$ in (2.6) yields

$$\frac{dT}{dZ} = \frac{-9.806\text{m/s}^2}{1005\text{J/kg-}^\circ\text{C}} \times \frac{1\text{J}}{\text{Kg-m}^2/\text{s}^2} = -0.00976^\circ\text{C/m} \dots\dots(2.7)$$

$$\Gamma = -\frac{dT}{dZ} = 9.76^\circ\text{C/km} \approx 10^\circ\text{C} \dots\dots\dots(2.8)$$

ATMOSPHERIC STABILITY

The ability of the atmosphere to disperse the pollutants emitted in to it depends to a large extent on the degree of stability. A comparison of the adiabatic lapse rate with the environmental lapse rate gives an idea of stability of the atmosphere.

When the environmental lapse rate and the dry adiabatic lapse rate are exactly the same, a raising parcel of air will have the same pressure and temperature and the density of the surroundings and would experience no buoyant force. Such atmosphere is said to be neutrally stable where a displaced mass of air neither tends to return to its original position nor tends to continue its displacement

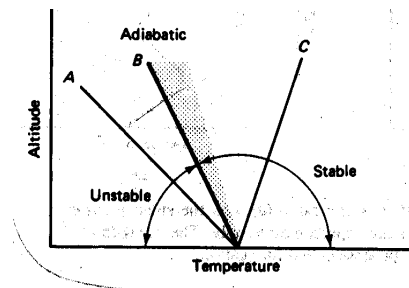

Figure 7.19 Temperature profiles to the left of the adiabatic lapse rate correspond to an unstable atmosphere (line A); profiles to the right are stable (line C). The dry adiabatic lapse rate is line B. The speckled area is meant to suggest slopes that correspond to the wet adiabatic lapse rate.

When the environmental lapse rate $(-dT/dz)_{Env}$ is greater than the dry adiabatic lapse rate, Γ the atmosphere is said to be super adiabatic. Hence a rising parcel of air, cooling at the adiabatic rate, will be warmer and less dense than the surrounding environment. As a result, it becomes more buoyant and tends to continue its upward motion. Since vertical motion is enhanced by buoyancy, such an atmosphere is called unstable. In the unstable atmosphere the air from different altitudes mixes thoroughly. This is very desirable from the point of view of preventing pollution, since the effluents will be rapidly dispersed throughout atmosphere.

On the other hand, when the environmental lapse rate is less than the dry adiabatic lapse rate, a rising air parcel becomes cooler and denser than its surroundings and tends to fall back to its original position. Such an atmospheric condition is called stable and the lapse rate is said to be sub adiabatic. Under stable condition there is very little vertical mixing and pollutants

can only disperse very slowly. As result, their levels can build up very rapidly in the environment.

When the ambient lapse rate and the dry adiabatic lapse rate are exactly the same, the atmosphere has neutral stability. Super adiabatic condition prevails when the air temperature drops more than $1^{\circ}\text{C} / 100\text{m}$; sub adiabatic condition prevail when the air temperature drops at the rate less than $1^{\circ}\text{C}/100\text{m}$

Inversion

Atmospheric inversion influences the dispersion of pollutants by restricting vertical mixing. There are several ways by which inversion layers can be formed .One of the most common types is the elevated **subsidence inversion**, This is usually associated with the sub tropical anti cyclone where the air is warmed by compression as it descends in a high pressure system and achieves temperature higher than that of the air under neath. If the temperature increase is sufficient, an inversion will result

- It lasts for months on end
- Occur at higher elevation
- More common in summer than winter

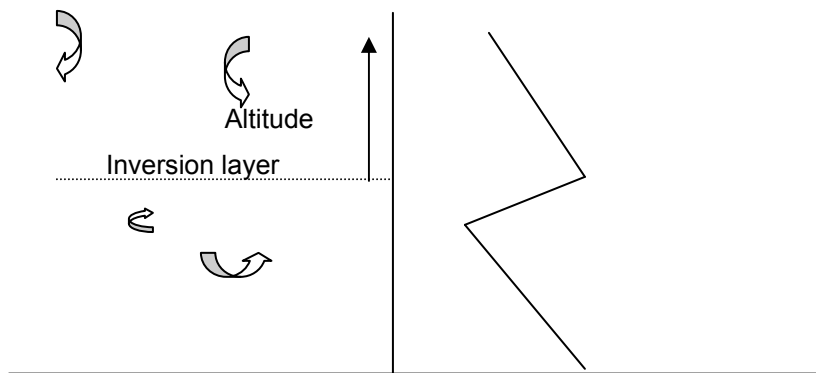

The subsidence is caused by air flowing down to replace air, which has flowed out of the high-pressure region

Radiation Inversion

The surface of the earth cools down at night by radiating energy toward space. On cloudy night, the earth's radiation tends to be absorbed by water vapor, which in turn reradiates some of that energy back to the ground. On the clear night, however, the surface more readily radiate energy to space, and thus ground cooling occurs much more rapidly. As the ground cools, the temperature of the air in contact with the ground also drops. As is often the case on clear winter nights, the temperature of this air just above the ground becomes colder than the air above it, creating an inversion. Radiation inversions begins to form at dusk .As the evening progresses, the inversion extends to a higher and higher elevation, reaching perhaps a few hundred meters before the morning sun warms the ground again, breaking up the inversion.

Radiation inversion occurs close to the ground, mostly during the winter, and last for only a matter of hours. They often begin at about the time traffic builds up in the early evening, which traps auto exhaust at ground level and causes elevated concentration of pollution for commuters. With out sunlight, photochemical reactions can not takes place, so the biggest problem is usually accumulation of carbon monoxide (CO). In the morning, as the sun warms the ground and the inversion begins to the break up, pollutants that have been trapped in the stable air mass are suddenly brought back to earth in a process known as fumigation. Fumigation can cause short-lived high concentrations of pollution at ground level.

Radiation inversions are important in another context besides air pollution. Fruit growers in places like California have long known that their crops are in greatest danger of frost damage on winter nights when the skies are clear and a radiation inversion sets in. Since the air even a few meters up is warmer than the air at crop level, one way to help protect sensitive crops on such nights is simply to mix the air with large motor driven fans.

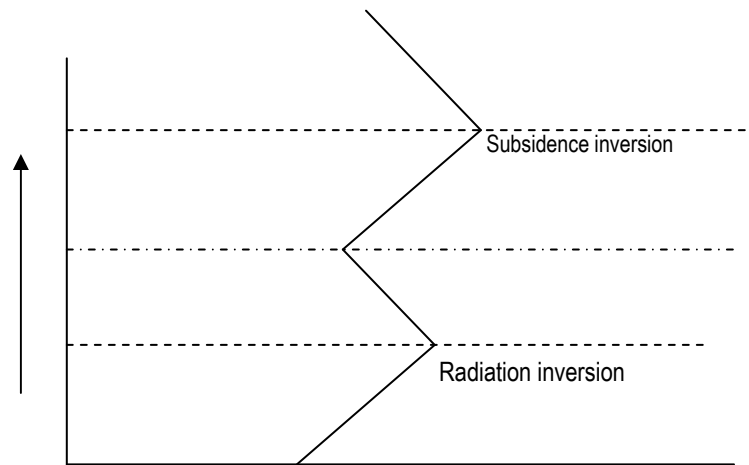

Temperature

The third type of inversion, known as advective inversion is formed when warm air moves over a cold surface or cold air. The inversion can be a ground based in the former case, or elevated in the latter case. An example of an elevated advective inversion occurs when a hill range forces a warm land breeze to follow at high levels and cool sea breezes flow at low level in the opposite direction.

TOPOGRAPHICAL EFFECTS

In large bodies of water the thermal inertia of the water causes a slower temperature change than the near by land. For example, along an ocean coastline and during periods of high solar input, the daytime air temperature over the ocean is lower than over the land. The relative warm air over the land

rises and replaced by cooler ocean air. The system is usually limited to altitudes of several hundred meters, which of course, is where pollutants are emitted. The breeze develops during the day and strongest in mid after noon. At night the opposite may occur, although, usually not with such large velocities. At night the ocean is relatively warm and the breeze is from the cooler land the warmer ocean. The on shore breeze is most likely in the summer months, while the off-shore land breeze more likely occur in winter months.

A second common wind system caused by topographical effect is the mountain - valley wind. In this case the air tends to flow down the valley at night Valleys are cooler at higher elevation and the driving force for the airflow result from the differential cooling. Similarly, cool air drains off the mountain at night and flows in to the valley. During the day light hours an opposite flow may occur as the heated air adjacent to the sun warmed ground begins to rise and flow both up the valley and up the mountain slopes. However, thermal turbulence may mask the daytime up- slope flow so that it is not as strong as the nighttime down - slope flow.

Both the sea breeze and the mountain valley wind are important in meteorology of air pollution. Large power stations are often located on ocean costs or adjacent to large lakes. In this case the stack effluent will tend to drift over the land during the day and may be subjected to fumigation.

2.4. Wind velocity and turbulence

The wind velocity profile is influenced by the surface roughness and time of the day. During the day, solar heating causes thermal turbulence or eddies set up convective currents so that turbulent mixing is increased. This results in a more flat velocity profile in the day than that at night.

The second type of turbulence is the mechanical turbulence, which is produced by shearing stress generated by air movement over the earth's surface. The greater the surface roughness, the greater the turbulence.

The mean wind speed variation with altitude in the planetary boundary layer can be represented by a simple empirical power.

$$\frac{U}{U_1} = \left[\frac{Z}{Z_1} \right]^\alpha \text{------(2.11)}$$

Where: U is the wind at altitude Z

U₁ is the wind speed at altitude Z₁

α The exponent varies between 0.14 and 0.5 depending on the roughness of the ground surface as well as on the temperature stability of the atm.

α = 0.25 for unstable atmosphere

= 0.5 for stable condition

In practice, because of the appreciable change in wind speed with altitude, a wind speed value must be quoted with respect to the elevation at which it is measured. This reference height for surface wind measurement is usually 10 meters

Table 2.1: Wind velocity in different topography

Surface configuration	Stability	α
Smooth open country	Unstable	0.11
	Neutral	0.14
	Moderate stability	0.20
	Large stability	0.33
Flat open country		0.16
Sub-urns		0.28
Urban area		0.40

Atmospheric turbulence is characterized by different sizes of eddies. These eddies are primarily responsible for diluting and transporting the pollutants injected in to the atmosphere. If the size of the eddies is larger than the size of the plume or a puff then the plume or the puff will be transported down wind by the eddy with little dilution. Molecular diffusion will ultimately dissipate the plume or the puff. If the eddy is smaller than the plume or the puff, the plume or the puff will be dispersed uniformly as the eddy entrains fresh air at its boundary.

2.5. Plume behavior

The behavior of a plume emitted from an elevated source such as a tall stack depends on the degree of instability of the atmosphere and the prevailing wind turbulence.

Classification of plume behavior

1. **Looping:** it occurs under super adiabatic conditions with light to moderate wind speeds on a hot summer after noon when large scale thermal eddies are present. The eddies carry portion of a plume to the ground level for short time periods, causing momentary high surface concentration of pollutants near the stack. Thus the plume moves about vertically in a spastic fashion and the exhaust gases disperse rapidly
2. **Conning:** It occurs under cloudy skies both during day and night, when the lapse rate is essentially neutral. The plume shape is vertically symmetrical about the plume line and the major part of the pollutant concentration is carried down -wind fairly far before reaching the ground level.
3. **Fanning:** occurs when the plume is dispersed in the presence of very light winds as a result of strong atmospheric inversions. The stable lapse rate suppresses the vertical mixing, but not the horizontal mixing entirely. For high stacks, fanning is considered a favorable

meteorological condition because the plume does not contribute to ground pollution.

4. **Fumigation:** here a stable layer of air lies a short distance above the release point of the plume and the unstable air layer lies below the plume .This unstable layer of air causes the pollutant to mix down -wind toward the ground in large lumps, but fortunately this condition is usually of short duration lasting for about 30 minutes Fumigation is favored by clear skies and light winds, and it is more common in the summer seasons.
5. **Lofting :** The condition for lofting plume are the inverse of those for fumigation , when the pollutants are emitted above the inverse layer , they are dispersed vigorously on the up ward direction since the top of the inversion layer acts as a barrier to the movement of the pollutants towards the ground .
6. **Trapping:** occurs when the plume effluent is caught between two inversion layers. The diffusion of the effluent is severely restricted to the unstable layer between the two unstable layers.

Vertical temperature gradient: _____

normal state

almost isothermal state

inverse state

a combination of an inverse state (above the ground) and a normal state (from a height slightly below the chimney orifice)

a combination of a normal state (above the ground) and an inverse state (above the chimney orifice)

a combination of a normal state (above the ground) and an inverse state (above the chimney orifice)

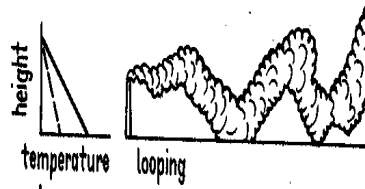

temperature

looping

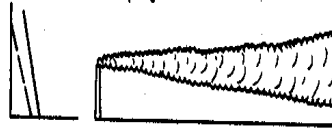

coning

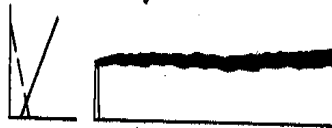

fanning

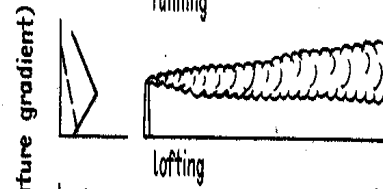

(adiabatic temperature gradient)

lofting

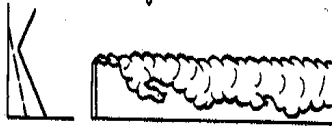

fumigation

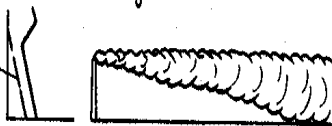

trapping

PLUME DISPERSION

Dispersion is the process by which contaminants move through the air and a plume spreads over a large area, thus reducing the concentration of pollutants it contains. The plume spreads both horizontally and vertically. If it is gaseous, the motion of the molecules follows the law of gaseous diffusion

The most commonly used model for the dispersion of gaseous air pollutants is the Gaussian, developed by Pasquill, in which gases dispersed in the atmosphere are assumed to exhibit ideal gas behavior

2.6. The Gaussian plume model

The present tendency is to interpret dispersion data in terms of the Gaussian model. The standard deviations are related to the eddy diffusivities

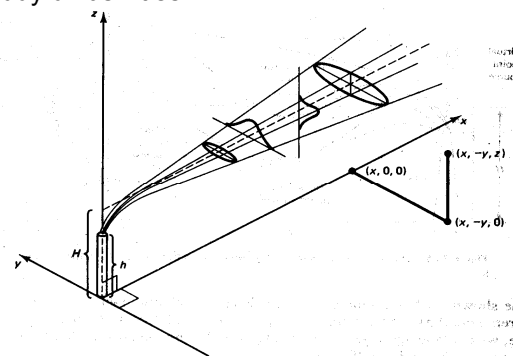

Plume dispersion coordinate system, showing Gaussian distributions in the horizontal and vertical directions (Turner, 1970)

Fig. Dispersion situation

- (a) Ground level concentration

In this case $Z=0$

$$[\rho A](x, y, 0, H) = \frac{Q}{\pi \delta y \delta z u} \exp\left(-\frac{1}{2} \left(\frac{y}{\delta y}\right)^2\right) \cdot \exp\left[-\frac{1}{2} \left(\frac{H}{\delta z}\right)^2\right] \text{--- (4.13)}$$

- (b) Ground level center line concentration

In this case $Z=0$ and $y=0$

- (c) When the emission source is at the ground level i.e. $H=0$

$$\boxed{} \frac{Q}{\pi \delta y \delta z u} \text{--- (2.15)}$$

Estimation of δy and δz

The values of δy and δz have been shown to be related to the diffusion coefficient in the y and z directions. As might be expected, δy and δz are functions of down wind distance x from the source as well as the atmospheric stability conditions. Based on the experimental observation of the dispersion of plumes, Pasquill and Gifford have devised a method for calculating δy and δz of the spreading plume from knowledge of the atmospheric stability. Six categories of the atmospheric stability; A through F, were suggested and these are shown in the table 2.1 as a function of wind and solar radiation

$$\delta y = Ax^{0.903} \text{-----} \quad (2.16)$$

$$\delta z = Bx^P \text{-----} \quad (2.17)$$

Where: A, B, and P are constants

Table 2.2 stability categories

Wind speed (m/sec) at z=10m	Day (incoming S. R.)			Night (thin over cast)	
	<i>Strong</i>	<i>Moderate</i>	<i>Slight</i>	$\geq 4/8$ cloud	$\leq 3/8$ cloud
<2	A	A-B	B	E	F
2-3	A-B	B	C	E	F
3-5	B	B-C	C	D	E
5-6	C	C-D	D	D	D
>6	C	D	D	D	D

A: extremely unstable D: Neutral condition
 B: Moderately unstable E: Slightly stable
 C: Slightly unstable F: Moderately stable

Table 2.3 fitted value for δy and δz

Class	A	X1(meters)	X \leq X1		X2(meters)	x1 \leq x \leq x2	
			B	P		B	P
A	0.4	250	0.125	1.03	500	0.00883	1.5
B	0.295	1000	0.119	0.986	1000	0.0579	1.09
C	0.2	1000	0.111	0.911	1000	0.111	0.911
D	0.13	1000	0.105	0.827	1000	0.392	0.636
E	0.098	1000	0.100	0.778	1000	0.373	0.587

Example 1

A coal burning electric generating plant emits 1.1 kg/ min. of SO₂ from a stack with an effective height of 60m. On a thinly over cast evening with a wind speed of 5 m/ sec. what is the ground level concentration of SO₂, 500m directly down wind from the stack .

$$\begin{aligned}\delta y &= Ax^{0.903} & \delta z &= BX^P \\ &= (0.13) \times 500^{0.90} & &= (0.105). (500)^{0.827} \\ &= 35m & &= 18m\end{aligned}$$

$$\begin{aligned}[\rho A](0.5,0,60) &= \frac{Q}{\pi \delta y \delta z u} \cdot \exp\left[\frac{-1}{2} \left(\frac{H}{\delta z}\right)^2\right] \\ &= \frac{18g/sec}{\pi \times 3.5 \times 18 \times 5} \cdot \exp\left[\frac{-1}{2} \left(\frac{60}{18}\right)^2\right] \\ &= 7.4\mu g\end{aligned}$$

Example 2

A chimney with a design stack height of 250 m s emitting SO₂ at a rate of 500g/sec on a sunny day in June with moderate wind speed at a stack altitude, the volumetric flow rate found to be 265m³/sec. , with a wind speed of 6 m/sec: at 10 m level .Estimate the concentration of SO₂ down wind for the following situations

(a) (ρ so2) (1000,0,0,250)

$$(b) (\rho_{SO_2}) (1000, 50, 0, 250)$$

$$(c) (\rho_{SO_2}) (1000, 50, 20, 250)$$

Solution

On a sunny day in June the incoming solar radiation will be strong. Also, the air will be unstable. A moderate wind speed at the stack altitude will be around 5-7 m/sec. Let us take $u = 6$ m/s. From equation 2.11 the velocity u_1 at 10 m level can be obtained:

$$\begin{aligned} u_1 &= u (z_1/H)^\alpha \quad \alpha = 0.25 \quad \text{unstable condition} \\ &= 6(110/250)^{0.25} \\ &= 2.7 \text{ m/sec.} \end{aligned}$$

This shows that the surface wind speed is between 2 and 3 m/sec. Reference to table 2.1 shows a stability class of A-B we choose B as a conservative answer. The values of δy and δz can be calculated from the information given in table 2 at a distance of 1000m

$$\begin{aligned} \delta y &= A \cdot x^{0.903} & \delta z &= Bx^P \\ &= 0.295(1000)^{0.903} & &= 0.119(1000)^{0.986} \\ &= 151\text{m} & &= 108\text{m} \end{aligned}$$

$$\begin{aligned} (a) [\rho_{SO_2}](1000, 0, 0, 250) &= \frac{500 \times 10^6}{\pi(151)(108)6} \exp\left[\frac{-1}{2}\left(\frac{250}{108}\right)^2\right] \\ &= 112 \mu\text{g/m}^3 \end{aligned}$$

$$\begin{aligned}
 \text{(b)} \quad [\rho_{SO_2}](1000,50,0,250) &= \frac{Q}{\pi \delta y \delta z u} \cdot \exp\left[\frac{-1}{2}\left(\frac{y}{\delta y}\right)^2\right] \exp\left[\frac{-1}{2}\left(\frac{H}{\delta z}\right)^2\right] \\
 &= \frac{500 \times 10^6}{\pi \cdot 151(108)6} \cdot \exp\left[\frac{-1}{2}\left(\frac{50}{151}\right)^2\right] \cdot \exp\left[\frac{-1}{2}\left(\frac{250}{108}\right)^2\right] \\
 &= 106 \mu\text{g}/\text{m}^3
 \end{aligned}$$

$$\begin{aligned}
 \text{(c)} \quad [\rho_{SO_2}](1000,50,20,250) &= \frac{Q}{2\pi \delta y \delta z u} \cdot \exp\left[\frac{-1}{2}\left(\frac{y}{\delta y}\right)^2\right] \left\{ \exp\left[\frac{-1}{2}\left(\frac{z-H}{\delta z}\right)^2\right] + \right. \\
 &\quad \left. \exp\left[\frac{-1}{2}\left(\frac{z+H}{\delta z}\right)^2\right] \right\} \\
 &= 113 \mu\text{g}/\text{m}^3
 \end{aligned}$$

2.7. Plume rise

Generally, effluent plumes from the chimney stacks are released into the atmosphere at elevated temperatures. The rise of the plume after release to the atmosphere is caused by buoyancy and the vertical momentum of the effluent. Under windless conditions, the plume rises vertically but more often it is bent as a result of the wind that is usually present. This rise of the plume adds to the stack an additional height ΔH , such that the height H of the virtual origin is obtained by adding the term ΔH , the plume rise, the actual height of the stack, H_s . The plume center line height $H = H_s + \Delta H$ is known as the effective stack height and it is this height that is used in the Gaussian plume calculations.

Plume rise

Estimation of plume rise

1. Buoyant plumes

In the case of buoyant plumes, the influence of buoyancy is much greater than the influence of vertical momentum. Such plumes are usually obtained when the release temperatures are more than 50 c greater than ambient atmospheric temperatures.

Holland's equation

$$\Delta H = \frac{V_s \cdot D_s}{U} \left(1.5 + 2.68 \times 10^{-3} p_a \cdot \frac{T_s - T_a}{T_s} \cdot D_s \right) \text{-----} (2.18)$$

Where: V_s = stack gas exit velocity, m/s

p_a = atmospheric pressure, mb

T_s = stack gas temperature, k

T_a = ambient air temperature

U = wind speed, m/sec.

D_s = Diameter of stack out let, m

2. Plume rise under stable and calm conditions

When there is little or no wind, the bending of the plume is negligible small and it rises to some height where the buoyancy force is completely dissipated. The recommended equation for such a situation is

$$\Delta H = 5F^{1/4} \cdot S^{-3/8} \text{-----} (2.19)$$

$$F = g v_s \left(\frac{D_s}{2} \right)^2 \cdot \frac{T_s - T_a}{T_s} \cdot \frac{m^4}{s^2} \text{-----(2.20)}$$

$$S = \frac{g}{T_a} \left[\left(\frac{dT}{dZ} \right)_{env.} + \Gamma \right] \times \frac{1}{\alpha^2} \text{-----(2.21)}$$

Where: F---is the buoyancy flux parameter

S---is the stability parameter

α --- Degree of stability

For large volume of flow rates greater than 50m³/s

$$\Delta H = 150 \frac{F}{(U^-)^3} \text{-----(2.22)}$$

3. Non- buoyant plumes

For sources at temperature close to the ambient or less than 50 ° C above ambient and having exit speed of at least 10m/sec, the following equation can be used

$$\Delta H = D_s \left(\frac{V_s}{U^-} \right)^{1.4} \text{-----(2.23)}$$

Example

If in example 2, the stack diameter is 5 m, the so2 exit velocity is 13.5 m/s, and the gas temperature of the exit is 145 C, what is the plume rise for an ambient air temperature of 30 C?

Calculate the ground level concentration, on the plume center line at the down wind distance of 1 km.

Solution

Flow rate = 265m³/s, which is far greater than 50m³/s

$$\Delta H = 150 \frac{F}{u^3}$$

$$F = 9.8(13.5) \left(\frac{5}{2}\right)^{2(1)} \left(\frac{418 - 330}{418}\right)$$

$$= 227 \text{m}^4/\text{s}^3$$

$$\Delta H = 150 \left(\frac{227}{(6)^3}\right)$$

$$= 158 \text{ m}$$

$$H = H_s + \Delta H$$

$$= 250 + 158$$

$$= 408 \text{m}$$

$$[\rho_{SO_2}](1000, 0, 0, 408) = \frac{500 \times 10^6}{\pi(151)(108)6} \cdot \exp\left[\frac{-1}{2} \left(\frac{408}{108}\right)^2\right]$$

$$= 1.3 \mu\text{g}/\text{m}^3$$

There is a significant reduction in the ground level concentration as compared to the case for a zero plume rise, where $(\rho_{SO_2})(1000, 0, 0, 250) = 120 \mu\text{g}/\text{m}^3$

CHAPTER THREE

SOURCES, TYPES OF AIR POLLUTANTS AND THEIR EFFECTS

3.1. Learning Objective

After the completion of this chapter, the student will be able to:

1. Describe the Physiological effects of SO₂ and NO_x
2. Differentiate primary and secondary air pollutants.
3. Enumerate different types of physical forms of air pollutants.
4. Understand the harmful effects of smog

3.2. Introduction to the chapter

The health effects of ambient air pollution have been difficult to document with certainty until recent years. This is because of methodological problems in assessing exposure, other factors that cause respiratory disease (such as cigarette smoking, respiratory tract infections, and allergies), and the difficulty of studying such effects in large populations. Recently, however, a series of highly sophisticated and convincing studies from virtually every continent have demonstrated that air pollution has a major effect on human health.

Respiratory symptoms are the most common adverse health effects from air pollution of all types. Table 1.1 presents a summary of major health effects thought to be caused by community air pollution. Respiratory effects of air pollution, particularly complicating chronic bronchitis, may place an additional strain on the heart as well.

3.3. Common condition to which air pollution exposure may contribute

Air pollution is associated with increased risk of death from heart disease and lung disease, even at levels below those known to be acutely toxic to the heart. Mucosal irritation in the form of acute or chronic bronchitis, nasal tickle, or conjunctivitis is characteristic of high levels of air pollution, although individuals vary considerably in their susceptibility to such effects.

The eye irritation is particularly severe, in the setting of high levels of particulates (which need to be in the respirable range described and may be quite large soot particles) or of high concentrations of photochemical oxidants and especially aldehydes.

There is little evidence to suggest that community air pollution is a significant cause of cancer except in unusual and extreme cases. However, emissions from particular sources may be cancer-causing. Examples of cancer associated with

community air pollution may include point-source emissions from some smelters with poor controls that release arsenic, which can cause lung cancer. Smoke from cigarettes is generally much more highly carcinogenic than air pollution could be.

Central nervous system effects, and possibly learning disabilities in children, may result from accumulated body burdens of lead, where air pollution contributes a large fraction of exposure because of lead additives in gasoline.

Table 3.1: Examples of Common Conditions to Which Air Pollution Exposure May Contribute

Disease or condition	How air pollution may affect it	Associated factors
Eye irritation	Specific effect of photochemical oxidants, Possibly aldehydes or peroxyacetyl Nitrates; particulate matter (fly ash) as a Foreign body	Susceptibility differs
Acute bronchitis	Direct irritative effects of SO ₂ , soot and Petrochemical pollution	Cigarette smoking may have a more than Additive interaction
Chronic bronchitis	Aggravation (increase in Frequency or Severity) of cough or sputum Associated with any sort of pollution	Cigarette smoking, occupation
Asthma	Aggravation from respiratory irritation, Possibly on reflex basis	usually pre-existing respiratory allergy or airway hyperactivity
Headache	Carbon monoxide sufficient To lead to more than 10% carboxyhaemoglobin	Smoking may also increase carboxyhaemoglobin but not Enough to lead to headache
Lead toxicity	Add to body burden	Close proximity to lead source; Exposure at home

These health effects are better characterized for populations than for individual patients. Establishing a relationship between the symptoms of a particular patient and exposure to air pollution is more difficult than interpreting the likely health effects on an entire community.

It is important to understand that these pollutants are seasonal in their pattern. Both ozone and sulfates, together with ultra fine particulates, tend to occur together during the summer months in most developed areas. Ozone, oxides of nitrogen, aldehydes, and carbon monoxide tend to occur together in association with traffic, especially in sunny regions.

Some pollutants, such as radon, are only hazards indoors or in a confined area. Others are present both indoors and outdoors, with varying relative concentrations.

3.4. Types of pollutants

3.4.1 CONVENTIONAL

Sulfur Dioxide

Sulfur dioxide was a serious problem in air pollution in the earliest days of industrialization. It has been the major problem in reducing or acidifying air pollution during the period of rapid economic growth in many countries. It was one

of the major components of the so-called London Fogs, which had serious direct health effects as illustrated in Box 5.1.

In 1953, Amdur et al. studied the effects of sulfur dioxide on humans and found that, at least in acute exposures, concentrations of up to 8 ppm caused respiratory changes that were dose dependent. (This is one of the first studies to use physiological measurements as an indication of the effects of air pollution.) Later studies revealed that the main effect of sulfur dioxide is broncho constriction (closing of the airways causing increased resistance to breathing) which is dose dependent, rapid, and tended to peak at 10 minutes (Folinsbee, 1992). Persons with asthma are particularly susceptible and in fact asthmatics suffer more from the effects of sulfur dioxide than does the general public. Persons with asthma who exercise will typically experience symptoms at 0.5 ppm, depending on the individual.

Sulfate, the sulfur-containing ion present in water, remains a major constituent of air pollution capable of forming acid. Sulfate itself appears to be capable of triggering broncho constriction in persons with airways reactivity and it is a major constituent of ultrafine particulates. There are other acid ingredients in air pollution, such as nitric acid, but less is known about them. These acids, though, cause a phenomenon known as acid rain, with their emission into the air by industry and motor vehicles.

Because of their small size and tendency to ride along on particulates, acid aerosols such as sulfur dioxide, sulfates and nitrogen dioxide tend to deposit deeply in the distal lung and airspace. They appear to provoke airways responses in an additive or synergistic manner with ozone. They have also been implicated in causing mortality in association with ultra fine particulates.

SO₂ and sulfates are the principal chemical species that cause acid precipitation. They may be transported long distances in the atmosphere away from their source and result in acidification of water and soils.

BOX 5.1: London Fog

On December 5, 1952, a phenomenon known as a temperature inversion occurred in the atmosphere, in London, England. This resulted in a dense fog forming in the center of the city of London. (During a temperature inversion very little air movement occurs, and air, including the particle matter and other pollutants it contains, gets trapped in a given location. Suspended matter in the air can provide nuclei on which particles of moisture and other pollutants, such as acids, are deposited.)

During this time, the temperature hovered around 0 degrees Celsius. The burning of fossil fuels (coal) in open earth fires in

homes, in the industrial generation of electricity, and the emissions from transportation vehicles contributed to the atmospheric pollution. Measurements for total suspended matter (TSM) and sulfur dioxide were routinely made in both central and peripheral London during this time. During 6-8 December 1952, daily averages from all monitoring points increased about five-fold to 1.6 mg/m^3 . Peak values were 3 to 10 times the normal values, and were highest in central London. In comparison, the mean December 1957 concentration for TSM was in the range of 0.12 to 0.44 mg/m^3 .

The demand for hospital beds increased on December 8, and the Central London hospitals issued an Emergency Bed Warning that they had sufficient beds for fewer than 85% of applicants. The mortality rate in certain parts of London increased dramatically during this time. The major causes of death were due to a variety of respiratory related illnesses, cardiac illness and ill-defined illnesses. In addition, many animals (e.g. cattle) had to be slaughtered because of illness during this time, likely because of the fog.

Figure 1: Deaths in London Administration County and the Outer Ring by Weeks.

November 1952 – 10 June 1953

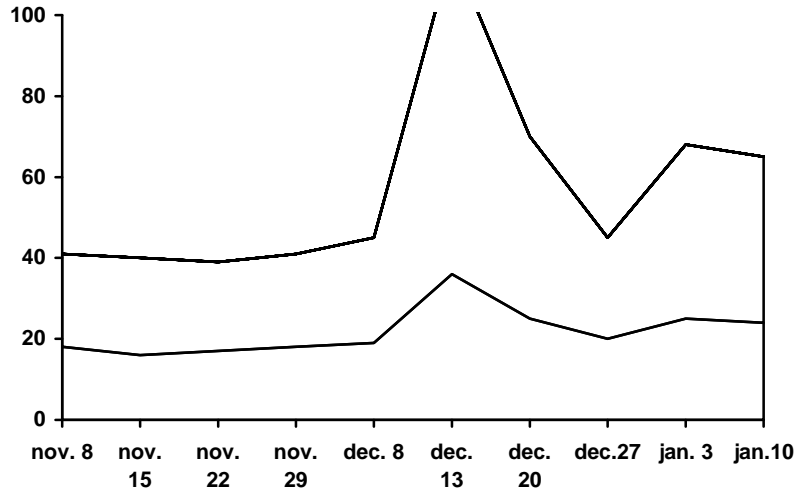

Based on the epidemiological data collected during the London smog episodes, it was felt at the time that the increased number of deaths in London during the fog was more closely related to the particulate matter in the air, rather than the SO_2 . A reanalysis later, though, suggested that the acid aerosols (e.g. sulfur dioxide) was the major factor in causing the increased mortality.

Adapted by A. Morham; from Kjellstrom and Hicks, 1991

Nitrogen Dioxide

Nitric oxide (NO) is produced by combustion. Nitrogen dioxide (NO₂), which has greater health effects, is a **secondary pollutant** created by the oxidation of NO under conditions of sunlight, or may be formed directly by higher temperature combustion in power plants or indoors from gas stoves. Levels of exposure to nitrogen dioxide that should not be exceeded (WHO guideline levels) are respectively 400 µg/m³ (0.21 parts per million (ppm) for one hour and 150 µg/m³ (0.08 ppm) for 24 hours (WHO, 1987a).

The direct effects of nitrogen oxide include increased infectious lower respiratory disease in children (including long-term exposure as in houses with gas stoves) and increased asthmatic problems. Extensive studies of the oxides of nitrogen have shown that they impair host defenses in the respiratory tract, increasing the incidence and severity of bacterial infections after exposure. They have a marked effect in reducing the capacity of the lung to clear particles and bacteria.

NO₂ also provokes broncho-constriction and asthma in much the same way as ozone but it is less potent than ozone in causing asthmatic effects.

Despite decades of research, however, the full effects of NO₂ are not known. Known human health effects are summarized

in Table 2.3. Other effects are known but difficult to evaluate. For example, NO has a major effect on blood distribution in the lungs. In animals, it has been shown that exposure to NO₂ makes metastases to the lung from cancer elsewhere in the body much more likely, although NO₂ does not itself cause cancer. These unusual effects are difficult to interpret and understand.

NO₂ is also a significant contributor to acid precipitation.

Table :- 3.2. Potential Human Effects of Nitrogen Dioxide

Health Effect	Mechanism
Increased incidence of respiratory infections	Reduced efficacy of lung defenses
Increased severity of respiratory infections	Reduced efficacy of lung defenses
Respiratory symptoms	Airways injury
Reduced lung function	Airways and possibly alveolar injury
Worsening of the clinical status of persons with asthma, Chronic obstructive pulmonary diseases or other chronic Respiratory conditions	Airways injury

Source: Samet and Utell, 1990

Particulates matter

Particle matter in the air (aerosols) is associated with an elevated risk of mortality and morbidity (including cough and bronchitis), especially among populations such as asthmatics and the elderly. As indicated, they are released from fireplaces, wood and coal stoves, tobacco smoke, diesel and automotive exhaust, and other sources of combustion. The US Environmental protection Agency (EPA) sets a standard of $265 \mu\text{g}/\text{m}^3$ in ambient air, but does not have a standard for indoor air levels. Usual concentrations range from $500 \mu\text{g}/\text{m}^3$ in bars and waiting rooms to about $50 \mu\text{g}/\text{m}^3$ in homes (Brooks et al., 1995). In developed countries, tobacco smoke is the primary contributor to respirable particles indoors.

Particulate matter (PM 10)

Larger particulates, which are included in PM_{10} (particulates $10 \mu\text{m}$ and smaller) consist mostly of carbon-containing material and are produced from combustion; some fraction of these are produced by wind blowing soil into the air. These larger particulates do not seem to have as much effect on human health as the smaller particulates.

Particulate matter (PM 2.5)

In recent years we have learned a great deal about the health effects of particles. As noted above, particulates in urban air pollution that are extremely small, below $2.5 \mu\text{m}$ in diameter,

are different in their chemical composition than larger particles. Particulates in the fraction $PM_{2.5}$ (2.5 μm and below) contain a proportionately larger amount of water and acid-forming chemicals such as sulfate and nitrate, as well as trace metals. These smaller particulates penetrate easily and completely into buildings and are relatively evenly dispersed throughout urban regions where they are produced. Unlike other air contaminants that vary in concentration from place to place within an area, $PM_{2.5}$ tends to be rather uniformly distributed.

$PM_{2.5}$ sulfate and ozone cannot be easily separated because they tend to occur together in urban air pollution. Recent research strongly suggests that at least $PM_{2.5}$ and sulfate, and probably ozone as well, cause an increase in deaths in affected cities. The higher the air pollution levels for these specific contaminants, the more excess deaths seem to occur on any given day, above the levels that would be expected for the weather and the time of year. Likewise, accounting for the time of the year and the weather, there are more hospital admissions for various conditions when these contaminants are high. Ozone, particularly, is linked with episodes of asthma, but all three seem to be associated with higher rates of deaths from and complaints about lung disease and heart disease. It is not yet known which is the predominant factor in the cause of these health effects, and some combination of each may be responsible for some effects.

Although the effect of air pollution is clearly present in the statistics, air pollution at levels common in developed countries is probably much less of a factor in deaths and hospital admissions than the weather, cigarette smoking, allergies, and viral infections. However, the populations exposed to air pollution are very large, and even if only 5% of all excess deaths during a one-week period are related to air pollution in a major city, a reasonable estimate, this means that thousands of deaths could be prevented. One unexpected finding of this research is that the effect of particulate air pollution on deaths and hospital admissions is continuous from high levels to low levels of exposure. In other words, there is no obvious level below which the public is clearly protected, and even at low levels of air pollution, some excess deaths still seem to occur. At first, it was thought that these deaths represented sick people who would soon die anyway. If this were true, one would expect there to be fewer deaths than expected when air pollution levels returned to normal or below normal, but a careful study of the death rate during and just after periods of high air pollution levels does not seem to show this.

At the much greater levels encountered in many developing countries, the effect is likely to be proportionately greater. There are many factors at work that complicate such studies in developing countries. The very high rates of respiratory disease during the winter among even non smokers in some

northern Chinese cities, for example, has been attributed to air pollution and this is likely to be true, however, cigarette smoking, indoor air pollution from coal-fired stoves, crowded conditions and the risk of viral infections may also be important factors.

There remains much more work to do to understand this problem, but the essential message seems clear: at any level, particulate air pollution and possibly ozone are associated with deaths, and both are clearly associated with hospital admissions and health risks.

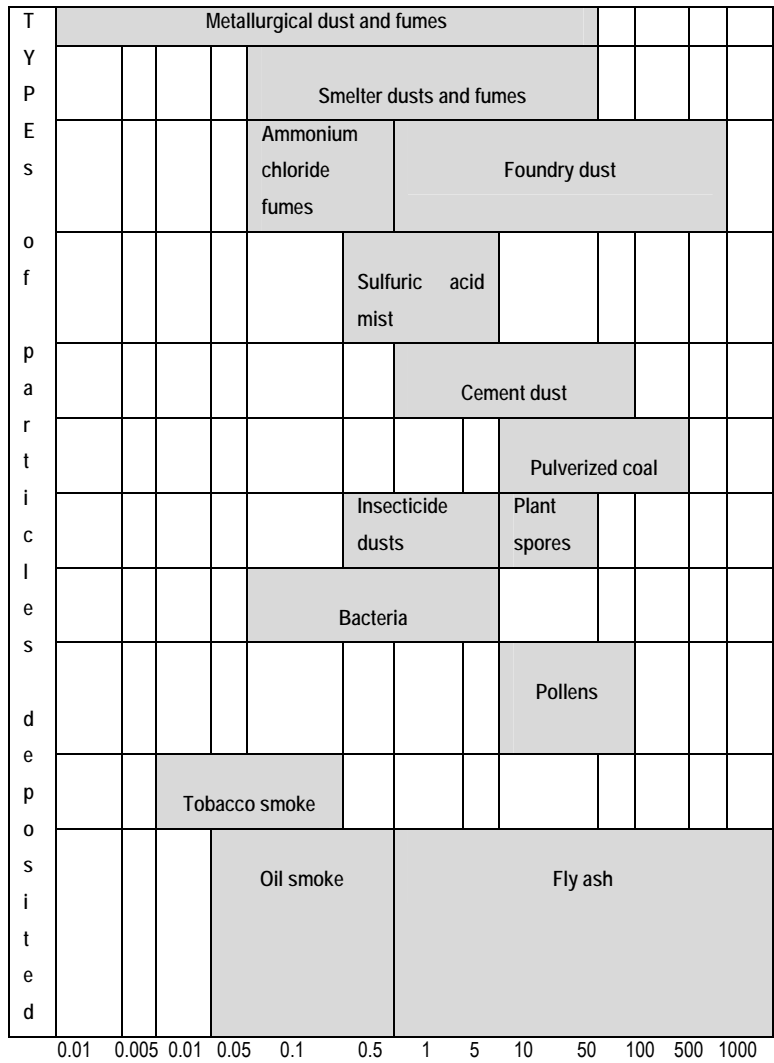

Particle size (μm) Source: Adapted from Levy and Wegman, 1988

Figure 2: Range of particle diameters from airborne dusts and fumes. Adapted from Levy and Wegman, 1988, with permission.

Hydrocarbons

Most hydrocarbons such as aliphatic and alicyclic hydrocarbons are generally biochemically inert at ambient levels and thus present little hazard. Aromatic hydrocarbons such, on the other hand, are biochemically and biologically active and are more irritating to mucous membranes. Compounds like benzo(a) Pyrene are known to be potent carcinogens. HCs are included among the criteria air pollutants, chiefly because of their role as catalysts in the formation of photochemical smog.

Lead

Lead is the best studied of these trace metals. It is known to be a highly toxic substance that particularly causes nerve damage. In children, this can result in learning disabilities and neurobehavioral problems. An estimated 80 – 90% of lead in ambient air is thought to be derived from the combustion of leaded petrol. Due to its effects on the behavior and learning abilities of children even at low levels of exposure, efforts throughout the world are directed at removing lead from gasoline. The WHO guideline value for long-term exposure to lead in the air is $0.5 - 1.0 \mu\text{g}/\text{m}^3/\text{year}$ (WHO, 1987a).

3.4.2 NON-CONVENTIONAL

Asbestos

Asbestos is a mineral fiber that has been used as insulation and as fire retardant in buildings. Many asbestos products have been banned, and its use is now limited. But in older buildings asbestos is still found in pipe and furnace insulation, asbestos shingles, floor tiles, textured paints, and other construction materials. If these materials are disturbed cutting, sanding or other activities, excessive air borne asbestos levels can occur. Improper attempts to remove these materials can also release asbestos fibers in to the indoor air. As a guide line, average asbestos levels should not exceed 0.1 fibers/ML for fibers longer than 5 μ m.

Health effects

- Asbestosis(lung scaring)
- Mesothelioma (cancer of the lung and the abdominal lining)
- Lung cancer

Mercury

It is present in gaseous form in the atm. because of its relatively high vapor pressure. The gaseous mercury is washed from the air by rain a portion of it enters the aquatic system and the remaining is bound to the soil over the land. In

both cases the inorganic mercury is generally converted into its methyl or diethyl compounds by the action of bacteria.

Beryllium

Most beryllium emissions are in the form of metallic powder or beryllium oxide particulate. A chronic condition known as berylliosis is thought to be caused by beryllium concentration as low as 0.01 to 0.1 $\mu\text{g}/\text{m}^3$. It is systematic poisoning which starts with progressive;

- Shortness of breaths
- Weight loss
- Cough
- Cardiac failure

Fluorides

Vegetation damage attributed to atmospheric fluoride has been accused from:

- Copper smelters
- Super phosphate
- Glass and enamel factories
- Aluminum plants
- Hydrogen (fluoride manufactory plant)

Animals may develop fluorosis (accumulation in bone) could result in

- Lameness
- Loss of weight
- Dental fluorosis

Ozone

Ozone is a highly reactive compound that irritates airways in the lungs and interferes with host defense mechanisms in the body. It also has an unusual effect on breathing patterns as the result of changes in the reflex breathing mechanism.

In the lower atmosphere, oxygen, with light from the sun as a source of energy, reacts with nitrogen compounds and volatile hydrocarbons to create ozone. This occurs especially in stagnant weather conditions and inversions under conditions of sunshine, where there is ample time for the photochemical reactions to take place. Ozone is chemically unstable, and will react with a variety of substances.

The way in which ozone affects humans appears to be complicated, and dependent on activity level and pollutant concentration, among other factors. Ozone appears to attack the epithelial cells in the bronchial tree, which in turn may cause airway inflammation and hyper responsiveness in the first place, although this has been hard to prove.

The WHO guidelines are 150–200 $\mu\text{g}/\text{m}^3$ (0.076–0.1 ppm) for one hour exposure and 100–200 $\mu\text{g}/\text{m}^3$ (0.05–0.06 ppm) for 8 hour exposures (WHO, 1987a).

Physical Forms of Pollutants

The constituents of air pollution may exist in any of the three phases of matter; they may be solid, liquid or gas. Often all three are present at once, especially in very small particulates.

Aerosols

Small solid or liquid particles (fine drops or droplets) that are suspended in air are called aerosols. Aerosols in air pollution are complex systems. They often consist of a mixture of solid-phase particles, combined solid- and liquid-phase particles, and sometimes liquid droplets. Even aerosols that are predominantly solid may contain absorbed water.

The most important characteristic that predicts the behavior of aerosols are size and composition. Size predicts how the particle will travel in air and composition determines what will happen when it settles or lands on something. Small particles are called **particulates**.

The individual particles in aerosols may be relatively uniform in size (monodispersed) or highly variable in size (**polydispersed**). Aerosols in air pollution are all polydispersed. **Fumes** are polydispersed fine aerosols consisting of solid particles that often aggregate together, so that many little particulates may form one big particle.

The effects that will be seen from a particular aerosol depend on how many of the particles there are of a particular size. Size is also related to mass; the smaller the particle, the less mass. In all polydispersed aerosols, the greatest number of particles will be small but together they will account for only a small fraction of the total mass; the larger particles will be much fewer but will carry most of the mass.

This means that air pollution includes solid-phase particles and sometimes droplets in a range of sizes, some of which will behave one way and others behave differently. Larger particles are kept up in the air by winds and local air movement and have a tendency to settle out by the effect of gravity if the air is very quiet. The smaller particles are kept up in the air by the movement of molecules in air (which is heat), a phenomenon called **Brownian movement**.

Size also relates to composition. Particles are generated with different dispersions depending on the source. The composition of particles of a given size, therefore, will depend on the local sources and their relative contribution to the aerosol in local air pollution. Large particles are most often the result of blowing dust or soot as the result of combustion. These particles are largely solid but may contain adsorbed gases or liquid on the surface. Smaller particles are mostly caused by certain types of combustion, associated with diesel exhausts, power plants, and other forms of rapid, hot

combustion. These small particles generally consist of a matrix of carbonaceous compound, some water, and dissolved or absorbed or solid-phase sulfate, nitrate, and trace metals. They may form from nitrates and sulfates in the air coming together in a solid form. They have different effects on the body than larger particles and are considered more toxic. The composition of an aerosol also determines the chemical reactivity of its individual particles and their density.

From the human health perspective, however, the most important aspect of particle size relates to how a particle behaves in the respiratory tract. In discussions of health, a special measure of size is used that is different than the actual measurement of the particle. It is called the **aerodynamic diameter** and it more reflects the behaviour of a particle than a physical measurement would. The aerodynamic diameter is the diameter of a sphere that would settle at the same velocity as the particle in question. This measure allows one to compare particles that are different in shape or density or mass. From this point on in the text, references to the size of particles will refer to the aerodynamic diameter expressed in micrometers (μm). Larger particles have more mass, therefore more inertia, and are therefore less likely to make it through the twists and turns of the human respiratory tract.

The effect of particulates on the body reflects the efficiency with which they penetrate all the way to and within the lung and their chemical reactivity and toxicity once they arrive. Larger particles carry much more substance but are much less likely to cause an effect on the body because they do not penetrate into the lower respiratory tract (below the first division of the windpipe, or trachea). The largest particles - visible to the naked eye as specks of dust, are mostly filtered out in the nose. Particles above 100 μm may be sources of irritation to the mucous membranes of the eyes, nose, and throat but they do not get much further. Those particles below this cut-off are called the **inhalable fraction** because they can be inhaled into the respiratory throat (trachea). Those particles below 20 μm generally do not enter the lower respiratory tract, below the throat (trachea). Those particles below 20 μm are called the **thoracic fraction** because they can penetrate into the lungs. Particles below 10 μm enter the airways with greatest efficiency and may be deposited in the alveoli, or air spaces, that are the deepest structures of the lungs. Notwithstanding the efficiency of penetration, particles smaller than about 0.1 μm tend to remain suspended in air and to be breathed out again. Thus, as a practical matter the greatest penetration and retention of particles is in the range 10.0 to 0.1 μm , which is called the **respirable range**. These patterns of deposition are shown graphically in Figure 2.

Once in the lung, particles may have different effects depending on their size. Particles predominantly in the size range between 10 and 20 μm are more likely to show effects on the airways. A large proportion of particles below 10 μm but above 0.1 μm may be retained in the lungs. When they accumulate to large numbers and the lung responds to their presence, they may cause a type of disease called **pneumoconiosis**; this is seen in high exposures in occupational settings, not as a consequence of ambient air pollution.

In air quality studies, the total aerosol suspended in air is measured as **Total Suspended Particulates (TSP)**. This measurement of what are sometimes also called **coarse aerosols** is not very useful except that as a measurement it reflects the perception of haze in the air and diminished visibility. Particulate matter of 10 μm and smaller is called **PM₁₀** or **fine aerosols**, and corresponds for the most part with the respirable range. Particulate matter of 2.5 μm and below is called **PM_{2.5}**, and is the most important fraction from the standpoint of health. Particles below **PM_{0.5}** are called **ultrafines**; their role in health has yet to be defined.

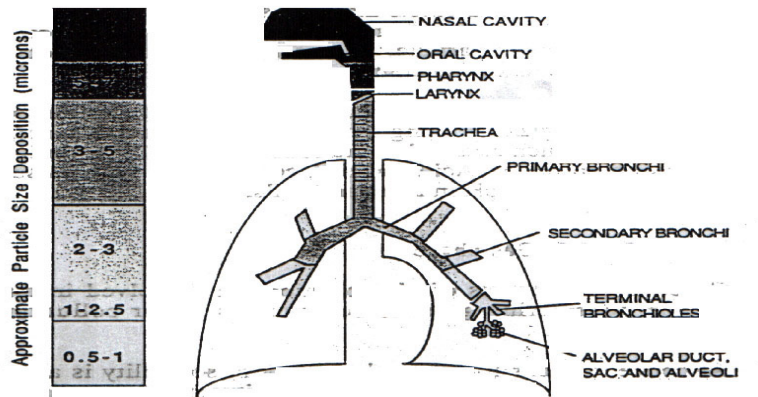

Reprinted from Newman, 1992

Figure 2: Deposition of Dust particles by size

Although it is disregarded for purposes of measuring the size of the particle, shape is important in determining the effects of a particle. The human body handles longer and thinner particles, which are called **fibers**, differently from particles that are more rounded in shape. Fibers are more difficult to remove from the lungs by natural protective mechanisms. There is also good evidence that the very long and thin shape of fibers of asbestos plays an important role in the damage it can cause in the lung.

Liquid phase

Liquid constituents of air pollution exist as aerosols, either as liquid-phase particles, which are **droplets**, or in association

with solid-phase particles. Liquids that are constituents of air pollution are always aqueous, or water-based, because droplets of more volatile organic compounds evaporate to the gaseous phase very quickly. A cloud or dense collection of droplets is called a **mist**.

Small solid-phase particles also contain a small amount of absorbed water. Both liquid and gas-phase constituents of air pollution often are attracted to and ride on the surface of solid particles; this is called **adsorption** (not to be confused with absorption, in which the liquid or gas is actually taken into the particle).

The humidity in the atmosphere is an important determinant of the water content of particles; the lower the humidity, the faster the water dries out and the particle is reduced to a solid phase. Dry particles may take on water when they are released into a humid atmosphere. Small particles typically absorb large amounts of water if it is available in the atmosphere; they are said to be **hygroscopic**. This adds mass to the particle and may increase its capacity to carry other dissolved constituents. Air pollution from the same types of sources may therefore be different in humid climates and dry climates.

There are processes in the atmosphere that convert liquid to gas and back again or over convert liquid to solid. Volatile liquids may evaporate to become gases. The evaporated

compound in the gas phase is called a **vapor** and behaves like a gas in air pollution. Droplets may also form from condensation of vapor in a saturated atmosphere. Fog is a familiar example of an aerosol of liquid water droplets that forms from condensation in an atmosphere saturated with liquid around a small solid particle. In coastal areas, the droplets of seawater may evaporate to form solid-phase particulates that contain salt.

Precipitation, in the form of rain and snow, reduced air pollution by dissolving soluble gases and by attracting and holding small airborne particles, bringing them down to the ground. The air may then be much cleaner but the constituents of air pollution in the rainwater or snow may present a serious problem. Acid-forming compounds, such as sulfates and oxides of nitrogen, may change the balance of pH in lakes and soils.

Gas phase

Gaseous constituents of air pollution are dissolved in air. The properties of greatest importance in considering gaseous constituents of air pollution are **solubility** in water and **chemical reactivity**.

At concentrations found in air pollution, solubility is a major determining factor of the health effects of gases. Relatively soluble constituents of air pollution include sulfates, nitrates

and sulfur dioxide. They may also coalesce to form ultra fine particles. (In addition, there are a number of gases more common as occupational exposures that are water-soluble, including hydrochloric acid vapor, and ammonia). Relatively insoluble constituents include the oxides of nitrogen and ozone. (Likewise, relatively insoluble occupational exposures include these and also phosgene, chlorine, and nitrogen dioxide.)

Solubility for gases is much like size for particles; it is a characteristic that determines the efficiency with which they penetrate deeply into the respiratory tract. A gas that is soluble in water will be dissolved in the water coating the mucous membrane of the lungs and upper respiratory tract and will be removed from air passing more deeply. A gas that is insoluble in water will not be so removed and will penetrate to the alveoli, the deepest structures of the lung, more efficiently. However, for gases at concentrations typical of ambient air pollution, penetration to the alveoli is not as significant as it may be for particles.

Gases that are reactive, such as ozone, tend to have their major effects on the airways rather than the alveoli even if they are relatively insoluble, except at very high concentrations. They may irritate the walls of the airway and cause bronchitis or induce asthmatic attacks, for example. Occupational exposures to toxic gases, or uncontrolled

releases during an industrial emergency, may expose workers or local residents to much higher concentrations than they would experience in ambient air pollution. In such cases the effects are correspondingly severe and may result in serious toxic effects at the alveolar level, such as pulmonary edema, a condition in which the damage to the lungs allows the accumulation of fluid in the lungs similar to drowning. In this situation the solubility of the gas is critically important as a determinant of toxicity.

As mentioned above, many gases, including ozone and sulfur dioxide, adsorb onto the surface of particulates and penetrate deeply into the respiratory tract in this way. When that happens the effects may be different and greater than exposure to either the particulate or the gas alone.

Inhalation

Inhalation of toxicants presents the most rapid avenue of entry into the body because of the intimate association of air passages in the lungs with the circulatory system. On inhalation, soluble gases tend to dissolve into the water surface of the pulmonary tract; insoluble gases generally penetrate to the alveolar level. Because the alveolus brings the blood into very close and direct proximity to air, gases may pass directly across the alveolar membrane and into the bloodstream very efficiently. Particles, once deposited in the alveoli, may dissolve and release their constituent

compounds. The degree to which they enter the blood and are circulated and are then delivered to the body's tissues depends on the concentration inhaled, duration of exposure, solubility in blood and tissue, reactivity of the compound and the respiratory rate. (The respiratory rate determines how much air is breathed in and therefore the total amount taken into the body.) To understand the health problems associated with airborne contaminants it is essential to have at least a basic understanding of the structure and function of the respiratory tract.

Anything that decreases the partial pressure of oxygen in the alveoli reduces the oxygen available for exchange and, therefore, has an asphyxiating effect. At high altitude, the partial pressure of oxygen in alveoli air decreases, reducing the saturation of blood with oxygen. Substances that dilute or displace the oxygen in air without any other effect are simple asphyxiants. Examples include carbon dioxide, nitrous oxide, nitrogen or hydrocarbons such as natural gas. Compounds that block the transfer of oxygen to the tissues or the utilization of oxygen once it reaches the tissues are called chemical asphyxiants. The two most common examples of such inhibitors of oxygen uptake or utilization are carbon monoxide (CO), which blocks the site on hemoglobin that binds and transports oxygen and hydrogen cyanide (HCN), which (in the form of cyanide) blocks the pathway by which the tissues utilize oxygen. Carbon monoxide is particularly

common place as a product of incomplete combustion of fuels (such as in automobile exhaust or open-flame heaters) and is especially dangerous because of its lack of an odor to give warning of exposure.

Chemical agents that irritate the lung may also impair oxygen uptake by different means. Irritants may inflame the respiratory tract, causing bronchitis or provoking an asthmatic attack, or causing the lungs to be filled with fluid (pulmonary edema), a process much like drowning. Usually the more highly water soluble the compounds, the higher in the respiratory tract they exert their effect.

Unlike many toxic substances that are ingested, inhaled compounds are not significantly metabolized prior to circulation throughout the body. They may therefore have a direct and immediate effect, not unlike direct injection into the bloodstream.

Volatile Organic Compounds

Volatile Organic Compounds (VOC) includes benzene, chloroform, methanol, carbon tetrachloride and formaldehyde among hundreds of other compounds. Gasoline is a mixture of many such compounds. In the past two decades some 261 VOCs have been detected in ambient air. While the majority of these chemicals occur in the environment at very low levels, some of these VOCs are highly reactive. Like nitrogen

compounds, they cause indirect effects (such as helping to create ozone) as well as having direct human physiological effects. They may originate from household products such as painting supplies, dry cleaning establishments, refineries, gasoline stations and many other sources. They can cause irritation to the respiratory tract (from increased rhinitis, or runny nose, to asthma) as well as headaches and other non-specific complaints. At high concentrations, they have markedly toxic effects, some of which vary by compound, but which include neurological effects in all cases. Direct toxicity from VOCs is primarily an indoor air pollution problem and an occupational hazard, as levels indoors and in the workplace can reach many times that of outdoor levels.

Trace Metals

The trace metals include cadmium, mercury, zinc, copper, lead, and a dozen others. They are called trace elements because they are present in the environment or body only in small amounts. Human activity has led to the increase in release of these elements into the environment. Trace metals may have direct health effects on the nervous and respiratory systems.

3.5. Magnitude and Sources of Ambient Air Pollution

Exposure to air pollution is part of urban living throughout the world. Over the past 20 years there has been a shift in the type of air pollution affecting developed countries, as the traditional pollutants from stationary sources (such as SO₂ and suspended particulate matter [SPM]) have been effectively controlled by the implementation and enforcement of legislation in many developed countries. Also, a change from domestic coal burning to electricity and natural gas for heating and cooking purposes has led to a lower level of emissions of SO₂ and SPM with a concomitant improvement in air quality. However, further economic development (and increasing personal wealth) has resulted in increase in industrial emissions, and especially in motor vehicle traffic. This in turn, has led to increases in pollutants associated with motor vehicle transport; most notably NO_x, carbon monoxide and hydrocarbons, as well as ozone and other photochemical oxidants and lead in many jurisdictions (see Box 3. for more on motor vehicle air pollution). Attempts to control emissions, primarily through the introduction of catalytic converters and more fuel efficient engines, have largely been outstripped by growth in motor vehicle traffic (see Mage and Zali, 1992). Meanwhile, in many developing countries, rapid urbanization has resulted in a duplication of many of the problems faced by

developed countries, remain high. In addition, rapid economic development has meant emissions from industry and motorized vehicles are increasingly causing air quality problems.

Urban environments generate their own microclimates (especially mega cities), which cause special problems. Air pollution trapped in urban areas by stagnant air, especially in a valley, may accumulate and may undergo chemical reactions that change its character. Some of the most severe situations of air pollution are in these world megacities, such as Mexico City and Sao Paulo (Brazil), and in cities in the developing world, such as shenyang (China). Also, many heated buildings can create a difference in ambient air temperature between urban and rural environments. This in turn can contribute to temperature inversions (a phenomenon with multiple causal factors which prevents warm air from rising. This leads to a concentration of air pollution, as noted earlier). People examining, and attempting to control urbanization must take these difficulties into consideration. For the United States in 1989, approximate percentages of sources for some of the pollutants are indicated in Table 8 and for Sao Paulo in Table 9. It can be seen that in both situations, transportation and industry are the major sources of pollutants.

Table 3.3: Sources of Pollutant Emissions, United States, 1989

	Particulate Matter	Sulfur Oxides	Carbon Monoxide	Nitrogen Oxides	Volatile Organic
Transportation	25%	4%	66%	40%	35%
Fuel consumption	22%	80%	13%	56%	5%
Industrial	39%	16%	8%	3%	44%
Solid wastes	3%	0%	3%	1%	3%
Miscellaneous	12%	0%	11%	1%	14%

Source: Statistics Canada, 1994

Table 3.4: Major types of occupational pulmonary disease

Pathophysiolog process	Occupational disease example	Clinical history	Physical examination	Chest x-ray	Pulmonary function pattern
Fibrosis	Silicosis	Dyspnea on exertion, shortness of breath	Clubbing, cyanosis	Nodules	Restrictive or mixed obstructive and restrictive DLCO normal or decreased
	Asbestosis			Linear densities, pleural plaques, calcifications	
Reversible airway obstruction (asthma)	Byssinosis, isocyanate asthma	Dyspnea on exertion, shortness of breath	Clubbing, cyanosis, rales	Usually normal	Normal or obstructive with bronchodilator improvement
Emphysema	Cadmium poisoning	Cough, wheeze, chest tightness, shortness of breath, asthma attacks	Respiratory rate ↑, wheeze	Usually normal	Normal or high DLCO
Granulomas	(chronic)	Cough, sputum, dyspnea	Respiratory rate ↑	Hyperaeration	Obstructive low DLCO
	Beryllium disease		↑ expiratory phase	bullae	
Pulmonary edema	Smoke inhalation	Cough, weight loss, shortness of breath	Respiratory rate ↑	Small nodules	Usually restrictive with low DLCO
			Coarse, bubble rales	Hazy, diffuse air-space disease	Usually restrictive with decreased DLCO, hypoxemia at rest
			Frothy, bloody sputum production		

DLCO= diffusing capacity; ↑ = increased.

Table 3.5: Common air pollutants, their sources and pathological effects on man

Ser. No.	Pollutants	Where they come from	Pathological effect on man
1	Aldehydes	Thermal decomposition of fats, oil or glycerol	Irritant nasal and respirator tract
2	Ammonia	Chemical processes dye-making; explosives; lacquer; fertilizer	Inflame upper respiratory passages
3	Arsine	Processes involving metals or acids containing arsenic soldering	Break down red cells in blood, damage kidneys, cause jaundice
4	Carbon monoxide	Gasoline motor exhausts; burning of coal	Reduce oxygen-carrying capacity of blood
5	Chlorine	Reach cotton and flour; many others chemical processes	Attack entire respiratory tract and mucous membranes of eyes; cause pulmonary edema
6	Hydrogen	Fumigation; blast furnaces; chemical manufacturing; metal plating	Interfere with nerve cells; produce dry throat, indistinct vision, headache
7	Hydrogen fluoride	Petroleum refining glass etching; aluminum and fertilizer production	Irritate and corrode all body passages
8	Hydrogen sulphide	Refineries and chemical industries; bituminous fuels	Smell like rotten eggs; cause nausea; irritate eyes and throat.
9	Nitrogen oxide	Motor vehicle exhausts; soft coal.	Inhibit cilia action so that soot and dust penetrate far in to the lungs
10	Phosgene (carbonyl chloride)	Chemical and dye manufacturing	Induce coughing, irritation, and sometimes fatal pulmonary edema
11	Sulphur dioxide	Coal and oil combustion	Cause chest constriction, headache, vomiting and death from respiratory ailments
12	Suspended particles (ash, soot, smoke)	Incinerators; almost any manufacture	Cause emphysema, eye irritants and possibly cancer

3.6. Exercise question

Study Exercise

- Consider the implications of particulates and gaseous constituents of: 1) wood smoke, 2) cigarette smoke, 3) automobile exhaust, 4) emissions from a coal-fired power plant.
- Which has the most pollutants of air pollution matter? Which is predominantly gas? Which is most complicated chemically? Which is likely to be most dangerous?
- Explain the effects of SO₂ on man?
- Describe the harmful effects of NO₂ on living things and the environment?
- Define Aerosol, dust and smoke?
- Describe the toxicological effects of CO in blood?

CHAPTER FOUR

INDUSTRIAL AIR POLLUTION

4.1. Learning Objective

After the completion of this chapter, the student will be able to:

1. Describe industrial air pollution
2. Enumerate common industrial air pollutants and their sources.
3. Identify health effects of air pollutants on Man.
4. Explain industrial air pollution accidents.

4.2. Introduction to the chapter

Industrial air pollution occurs as the result of the release of pollutants (called emissions) into the atmosphere. The pollutants mix in air and are diluted but may travel long distances on slow, steady winds if an industrial chimney is tall enough to propel them high into the atmosphere. It is a fundamental problem of air pollution science that pollutant concentrations are exceedingly difficult to measure accurately.

4.3. Types of Industrial Air Pollutants

There are three general types of industrial air pollution as defined by their different chemical characteristics, distribution, and sources (outlined in Table 6). **Reducing** air pollution is caused by the emission of sulfur dioxide (SO₂) and particulates, substances that are chemical reducing agents in the atmosphere. This is by far the oldest type of air pollution. Emissions of SO₂ are caused by burning fossil fuels mining coal containing some sulfur, emissions of particulates occur most heavily when combustion is inefficient. Reducing air pollution is produced primarily by stationary combustion sources, such as fossil fueled power plants, industrial furnaces and steel mills. This type of air pollution has predominated in older basic industry.

Table 4.1: Types of Air Pollution by Chemical Characteristics and Source

Type	Composition	Source
Reducing	Sulfur dioxide, particulates.	Stationary combustion sources, Such as fossil fuel power plants, industrial furnaces, home heating units.
Photochemical	Hydrocarbons and nitric oxide emitted by sources such as internal combustion engine undergo automobiles, fossil fuel power Complex photochemical reactions in the plants and oil refineries. Presence of sunlight, resulting in an atmosphere with significant concentrations of ozone, nitrogen dioxide, aldehydes, and organic nitrates.	Mobileemissions
Point Source	Specific to source of emission, e.g. lead Specific industries; near a smelter.	Industrial or transportation accidents.

Photochemical air pollution, much newer in human history, results from complicated chemical reactions in the atmosphere that are driven by the energy in sunlight. In photochemical smog, emissions rich in oxides of nitrogen and hydrocarbons undergo reactions to produce ozone, specific

compounds of nitrogen and aldehydes -all of which are highly reactive and chemically oxidizing. This type of smog is caused primarily by automobile traffic, to which are added emissions from mobile sources, such as hydrocarbons from gasoline and dry cleaning solvents and oxides of nitrogen from power plants. Many cities have been able to bring reducing air pollution under control. However, as automotive traffic has increased worldwide, photochemical smog has emerged as a problem.

A third type of industrial air pollution is **point-source emissions**. This type affects the immediate vicinity of the plant, but does not usually involve atmospheric reactions to any great extent. Examples include lead in the vicinity of a smelter, hydrogen sulfide from a sewer gas well, pesticides from agricultural application, and concentrated fumes from a spill or tank rupture. Such emissions are frequently the result of accidents, particularly related to transporting hazardous substances by truck or train. Chemicals that are not regulated under usual air quality standards are often called air toxics.

4.4. Air Pollution from Industrial Accidents

Industrial activities or accidents may release a relatively large quantity of a particular type of air pollution that becomes a local problem. Severe episodes that have been well documented include one in Belgium in 1930 (Meuse Valley),

one in the US in 1948 (Donora, Pennsylvania), one in Mexico in 1950 (Poza Rica), two in England in 1952 and 1962 (both in London – see Box 1.), and one in India in 1984 (Bhopal). The Bhopal incident is presented in Box 2.

BOX 2.

Bhopal – A Case Study of an International Disaster

Arguably, the world's worst industrial cataclysm occurred on 2 December 1984 at the Union Carbide Plant in Bhopal, India, where a release of a gas cloud of methylisocyanate killed over 3800 people.

With respect to the historical facts leading up to the disaster, it is noteworthy that the post-World War II era witnessed a dramatic world-wide increase in the production of organic chemicals. The application of pesticides in particular was encouraged and became widely prevalent. Although the impacts on occupational and environmental health were beginning to be realized, the necessity for greater food production despite inadequate safety testing led to the continued use of these chemicals in everyday life. Early in the 1970s governments of many developed countries recognized the need to adopt a proactive role for government intervention and regulation in this area. This, combined with the fact that markets in developed countries approached saturation, led to the multinational corporations turning their attention to the developing world, where public health concerns for occupational and environmental health were low. These conditions led to an increase in the international mobility of hazardous products, industry, and wastes to these lucrative markets of cheap labour, with only its costs and relative indifference to occupational and environmental health standards.

What was described in one report as a "normal accident" was apparently initiated by the introduction of water into the MIC storage tank, resulting in an uncontrollable reaction, with liberation of heat and escape of MIC and other decomposition products in the form of a gas. Safety systems were either not functioning or were inadequate to deal with large volumes of the escaping toxic chemicals.

Among the more than 200,000 persons exposed to the gas, the initial death toll within a week following the accident was over 25,000. By 1990, the Directorate of Claims in Bhopal had prepared medical folders for 361,966 of the exposed persons. Of these, 173,382 had temporary injuries and 18,922 had permanent injuries, with the recorded deaths totaling 3,828.

One of the most important lessons of the Bhopal tragedy is how important it is to prevent these incidents by taking action in advance. Environmental legislation, preventive maintenance strategies,

worker-training programmes, environmental education programmes, research on intermediate products, development of systematic hazard-evaluation models, emergency planning, and disaster preparedness are all examples of such activity.

International agencies such as the United Nations Environmental Programme (UNEP), the International Labour Organization (ILO), and the World Health Organization (WHO) play a key role in preventing such disasters.

Source: Dhara and Dhara, 1995

4.5 Air Pollution in the Workplace

Airborne hazards are common problems in occupational health. Several diseases are known to be caused by inhalation of substances found in particular occupations. For each category of disease noted in Section 5.2, there are long

lists of workplaces where such diseases have been documented to be excessive due to inadequate air quality controls. The incidence and prevalence of these conditions have changed over time. For example, the fibrotic lung diseases (those that cause scarring of the lungs) used to be quite prevalent, and still are in developing countries where exposure controls are inadequate. This category of diseases includes silicosis, asbestosis, coal miners' pneumoconiosis, and others. Occupational lung cancer, chronic obstructive lung diseases and chronic bronchitis are well documented as occurring in association with workplace exposures. Occupational asthma is now increasingly common, with the list of substances known to be capable of causing asthma growing rapidly.

Suffice it to note that there are by far more cases of disease caused by air pollution inside a workplace than by exposures to the general community outside. Also, for many people, the distinction between the work environment, the home, and the general environment is an artificial distinction. Exposure control in the community should always be linked to exposure control inside the plant, and the fact that exposures are usually much higher inside the plant should always be taken into account in prioritizing prevention activities.

4.6. Exercise question

EXERCISE QUESTION

1. Define industrial air pollution
2. What are the three different types of air pollutants based on chemical characteristics.
3. Describe some of the air pollutants and their effect.
4. Explain Bhopal gas tragedy.

CHAPTER FIVE

GLOBAL ENVIRONMENTAL PROBLEMS DUE TO AIR POLLUTION

5.1. Learning Objective

After the completion of this chapter, the student will be able to:

1. Describe the factors that contribute for global warming
2. Identify the different green house gases.
3. Enumerate the potential adverse health effects of global warming.
4. List different international responses to ozone depletion.

5.2. Introduction to the chapter

The CO₂ concentration in the atmosphere is 25% higher than what it was at the beginning of the century. Large scale deforestation, burning of chemical and fossil fuel have created this increase. Climatologists believe that even a small increase atmospheric CO₂ can have major effects on climate. CO₂ is transparent to incoming visible sun energy, but like glass, it absorbs infrared heat reradiated from the earths surface. This is called green house effect. The earth planet has already been warmed by 0.8 to 2.5°C and is going to get

hotter by 3 to 5°C within the next century. It is feared that even a slight increase in temperature would cause the polar ice caps to melt and raise the sea level, submerging a number of major cities of the world, because many are along the seacoast.

5.3. Global warming

What is global warming?

- ❖ The fate of solar energy when it reaches the earth
- ❖ Absorption by earth and natural greenhouse gases (CO₂, CH₄, water vapor); Infrared radiation reflection by earth's crust;
- ❖ Infrared radiation absorption by the greenhouse gases;
- ❖ Infrared radiation retention by greenhouse gases;
- ❖ Resulting in an acceptable level of temperature at the earth at 15°C
- ❖ Could have been 19°C less if the reflected heat from the earth escaped to space.
- ❖ IR absorption by greenhouse gases as a function of concentration of these gases.

Anthropogenic (man made) "greenhouse gases" and their sources:

1. CO₂: fossil and bio-mass fuel burning, forest fire, etc.
2. N₂O: N₂ containing fertilizers processing, vehicles

3. CH₄: animal dung decomposition, waste landfills, wet lands, etc
4. CFCs: factories.
5. CO₂ and CFCs are main contributors to IR absorption:
6. 1980 UNEP IR absorption contribution: 55%, 24%, 15% 6% by CO₂, CFCs, CH₄, Nitrous oxide, respectively

Potential health effects due to global warming

General points:

- Average earth's temperature variation:
- 0.6⁰C/past 100 years; forecasted: 1-3.5⁰ C/next 100 years
- (an increase of 1⁰C/700 yrs versus today 1⁰C/35 yrs).
- An increase of 2⁰C would result events not seen before 125 000 years ago. Variations in climatically factors: wind velocity, rainfall, etc.
- Variations in the ability to respond to the effects: economics and susceptibility.

Effects: Direct and Indirect:

A/ Direct effects:

1. Thermal extreme effect: (heat waves) the skin, CNS and Circulatory system the most affected: thermo-regulation disturbance; heat stroke and exhaustion, decreased male fertility, cerebro-vascular stroke, etc.

2. Effect on the respiratory organs: persons with chronic diseases like asthma, bronchitis, cardiovascular are the most affected.
3. Weather instability and natural calamities: cyclones, land slides, draught, flooding, etc.

B/ Indirect effects:

1. Vector borne diseases: mosquitoes (malaria, yellow fever, rift valley fever); Tsetse fly (African sleeping sickness); Fly (faeco-oral related diseases, onchocerciasis, leishmaniasis, schistosomiasis.)
2. Waterborne diseases: due to water shortage & contamination
3. Sea-level rise: damages fresh water, affects soil salinity,
4. Agricultural productivity:
 - Reduced rainfall; increased pests; decreased soil fertility; decreased farming land, etc.
 - Affects both staple foods & horticulture harvesting; and animal husbandry.
5. Food shortages and malnutrition;
6. Air pollution impact: increased pollen; concentration of pollutants;
7. Impacts to socio-economic development.

5.4. OZONE DEPLETION

Identity: found in stratosphere in nature as O₃; its detection in troposphere (ground level) is an indicator of pollution.

Its role:

- Solar radiation: 55% IR; 40% visible light; 5% UV.
- Acts as a UV protective blanket (layer).
- UV radiation includes three bands: UVA (400-320nm); UVB (320-280nm); UVC (280-200nm), far UV (< 50nm).
- It blocks nearly all UVC, half UVB, and small part UVC.

Mechanism for UV blocking:

- Equilibrium in nature between destruction and production of O₃.
- $O_2 \rightarrow O+O$ (energized by UVC)
- $10+O_2 \rightarrow O_3 + IR$ (production of Ozone)
- $O_3 + UV \rightarrow O_2+O$: (destruction of Ozone as energized by UVB)

What causes Ozone depletion?

- Human activity: release of halogenated hydrocarbons: CFCs; CCl₄;
- Are used as refrigerants, propellants, solvents, foam production, etc.
- Are stable under normal conditions in the troposphere.

- These volatile chemicals become active with the presence of UV to react with O₃;

The reaction:

1. $\text{CCl}_2\text{F}_2 + \text{UV} \rightarrow \text{CClF}_2 + \text{Cl}^\cdot$
2. $\text{Cl}^\cdot + \text{O}_3 \rightarrow \text{ClO} + \text{O}_2$
3. $\text{ClO} + \text{O} \rightarrow \text{Cl}^\cdot + \text{O}_2$
4. Net: $\text{O}_3 + \text{O} \rightarrow 2\text{O}_2$ (Chlorine atom acts as a catalyst).

Potential adverse effects:

- UVC is absorbed by O₃, (does not reach the earth);
- UVB and UVA reach the earth.

A/ Direct effect:

1. Skin damage and cancer:

- Acute exposure: thermal extremes due to UV: sun burn; skin lesions;
- Cumulative (chronic) exposure: skin cancer in fair skinned humans;
- UNEP estimates: 5% skin cancer increase during 2070's (extra 100 cases of skin cancer per million population per year) in Europeans living at around latitude 45 degrees N)

- 2. Effects on eye:** by UVB; cornea, lens, and retina: cataract (snow blindness): UNEP estimates: 1.75 million additional cataract cases worldwide each year due to 10% loss of ozone.

3. Effects on immune system

- Skin sensitivity; animal tests; possible effects.

B/ Indirect effects:

- Effects on plants: impairs photosynthesis & UVB; farm productivity declining
- Effects on aquatic system: Phytoplankton & UVB; aquatic farm productivity declining. CO₂ take up will be diminished.

INTERNATIONAL RESPONSE TO OZONE DEPLETION:

1. The Montreal Protocol on substances that deplete the ozone layer in 1987, and its amendments in London (1990) and Copenhagen (1992);

Issues in the protocol:

- Ozone depletion is actually observed;
 - Few products were involved in the depletion: CFCs, methyl chloroform, methyl bromide.
 - Few producers were involved.
2. A climate Convention signed in RIO De-Janioro in June 1992; (Agenda 21).
 3. The Kyoto (Japan) protocol signed in March 1998;
 4. A legal binding ratification by protocol signatories is underway

Perspectives of operating in harmony with climate and weather

- Biometeorology and bioclimatology: for climate changes study and assessment;
- Early warning systems;
- Building designs and Urban planning;
- Disaster mitigation planning;
- Environment and sustainable development.

5.5 Acid rain

ACID DEPOSITION

Rain fall by nature is slightly acidic due to the tendency to each chemically with atmospheric CO₂. Forming a weak solution of carbonic acid with PH 5.6, by definition any ppt measuring less than 5.6 on the pH scale is considered acid rain.

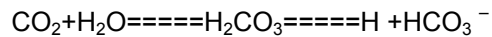

$$\text{PH} = \log_{10} [1/\text{H}^+]$$

Carbonic acid created by CO₂ in air

- Volcanic emission
- Biological decomposition
- Chlorine & sulfates from ocean spray can drop the pH of ppt below 5.6 while, alkaline dust can raise the pH above 7

Acid rain is only one form in which acid deposition occurs. Fog, snow, mist, and dew also trap and deposit atmospheric contaminants. Furthermore, fall out of dry sulfate, nitrate, and chloride particles can account for as much as half of the acidic deposition in some areas.

Extent of the problem

A factor that complicates the acid rain problem and makes finding a solution difficult is its regional and continental scale. Most oxides of sulfur and nitrogen are emitted from tall stacks at power plants in order to increase the dispersion and dilution of the stack gases. This may protect near by communities from the immediate effect of air pollution, discharge from tall chimneys allows the pollutants to be carried for long distance in the atmosphere. The pollution in its effect is "air mailed" to other regions and even to other continents. It is estimated that 50% of the acid rain in eastern Canada comes from the USA, and about 25 % of the acid rain in the New England originates from Canadian sources. In addition, acid rain in Norway is believed to come mostly from industrial areas in Great Britain and continental Europe.

Formation of acid rain

SO_2 ----- H_2SO_4	62 %
NO_2 ----- HNO_3	32%
Cl ----- HCl	6%

In urban areas, where transportation is the major sources of pollution, nitric acid is equal to or slightly greater than sulfuric acid in the air.

Environmental effect of Acid Rain

1. Damage to aquatic life

Reproduction is the most sensitive stage in the life cycle

Eggs and fry of many fish species are killed at pH 5.0

Disrupt the food chain by killing:

Plants

Aquatic Insects

Invertebrate on which fish dependent on food

At pH level less than 5

- Adult fish die
- Trout, salmon
- Game fish

Acidity

- Alters body chemistry
- Destroy gills prevent oxygen up take
- Causes bone decalcification
- Disrupt muscle contraction

Phytoplankton population are reduced, and many common water, dwelling invertebrates such as may flies and stone flies can not survive when the Ph falls below 5.5

Acid dead lakes have pH below about 3.5

2. Deterioration of buildings and monuments

Most glorious buildings and works of art are being destroyed by air pollution:

- Smoke and soot coat buildings
- Paintings
- Textiles
- Lime stone and marble are destroyed by atmospheric acid at an alarming rate

Air pollution also damages

- Ordinary buildings
- Corroding steel
- Weakens buildings, roads, bridges
- Rubber deterioration

3. Mobilization of toxic metal

Acid rain can cause lightly bound toxic metals such as aluminum which can kill fish by damaging their gills and causing asphyxiation.

It also cause leaching of heavy metals: Hg, Cd in to drinking water and results in Bio accumulation

4. Damage to forest productivity

In 1983 in Germany some 34 % of the forest was affected and in 1985n, more than 4 billion hectares (50%) were reported to be in the state of decline Show evidence of:

- Root necrosis
- Lack of seeding growth
- Premature tree death
- Growth reduction
- Defoliation

High altitude forests are subjected to especially intense doses of these acids because clouds saturated with pollutants tend to hang on , mountain tops, bathing forests in a toxic soap for days even weeks at a time

5. visibility reduction

Particulates in the atmosphere reduce the visibility due to scattering and absorption of light. The dust particles of 2000/Cm³ can obscure a mountain at 75 km; while a concentration of NO₂ of 20 ppm would probably reduce the visibility to 1 km. NO₂ causes the sky to appear brownish in color in addition to reducing visibility.

A relationship between the concentration of the particulate in the atmosphere, and the visibility can be developed as follows

$$L_v = 5.2\rho r/kc$$

Where: L_v Visibility

K scattering area ratio

C particulate concentration

ρ Particle density

r particle radius

Example

Consider oil droplets 0.6 μ m diameter suspended in air and exposed to day time radiation .The density of the particle is 0.9 gm/cm³.

- (a) What is the concentration of the particle in μ g/m³ for a visibility of 1.5 km , If the k value is 4.0
- (b) What is the concentration of suspended particulates in the density of 2.5 gm/cm³ and an effective diameter of 1.0 μ , if k is 2.0 and visibility is reduced to 8 km?

Solution

$$(a) \quad c = \frac{5.2\rho r}{kLv} = \frac{5.2 \times 0.9 \times 0.3}{4 \times 1500} = 234 \mu\text{g} / \text{m}^3$$

$$(b) \quad C = \frac{5.2\rho r}{kLv} = \frac{5.2 \times 2.5 \times 0.5}{2 \times 8000} = 406 \mu\text{g} / \text{m}^3$$

5.6. Exercise question

EXERCISE QUESTIONS

1. What is global warming?
2. What is acid rain and its effect?
3. Describe the direct and indirect health effects of global warming?
4. List the cause of ozone depletion? And its potential health effects?

CHAPTER SIX

INDOOR AIR POLLUTION

6.1. Learning Objective

After the completion of this chapter, the student will be able to:

1. Differentiate indoor and outdoor air pollution.
2. Identify the source type and effect of indoor air pollution.
3. List different control measures of indoor air pollution.

6.2. Introduction to the chapter

Inefficient combustion and smoky fuels burned for cooking and heating are a troubling source of serious air pollution in many traditional and developing societies. The use of such fuels causes air pollution problems both indoors and outdoors.

The quality of air indoors is a problem in many buildings in developed countries because they were built to be airtight and energy efficient. Chemicals from burning fuels, smoking and other sources in the building accumulate and create a pollution problem. Indoor air pollution is also a serious problem in many developing societies. In homes where open fires burn, especially when the climate is cold, the pollution

from the fires accumulates and exposes the inhabitants, especially women, to the risks associated with smoke inhalation. The result can be serious lung disease and an increased risk of cancer, as occurs in some parts of China among women who tend fires in homes heated with coal.

Indoor air pollution has been identified as one of the foremost global environmental problems (World Bank, 1993). An SPM level of 50-100 $\mu\text{g}/\text{m}^3$ may cause health effects (WHO, 1987a). Rural people in developing countries may receive as much as two thirds of the global exposure to particulates. Women and young children suffer the greatest exposure.

Indoor air pollution contributes to acute respiratory infections in young children, exacerbation of asthma, chronic lung disease and cancer in adults, and adverse pregnancy outcomes for women exposed during pregnancy. Acute respiratory infections, principally pneumonia, are the chief killers of young children, causing a loss of 119 million disability adjusted life years (DALYS) per year or 105 of the total burden of disease in developing countries (World Bank, 1993). Data from the Gambia, Nepal, South Africa, the United States, and Zimbabwe suggest that reducing indoor air pollution from very high to low levels could potentially halve the incidence of childhood pneumonia. Adults can suffer chronic damage to the respiratory system from indoor pollution.

The most important indoor air contaminants in developed countries are tobacco smoke, radon decay products, formaldehyde, asbestos fibers, combustion products (such as NO_x, SO_x, CO, carbon dioxide and polycyclic aromatic hydrocarbons), and other chemicals used in the household. Several microbiological air contaminants are also of importance including moulds and fungi, viruses, bacteria, algae, pollen, spores and their derivatives. In airtight buildings especially (e.g. buildings which are energy efficient, but with poor ventilation), indoor air pollutants can accumulate, causing tight building syndrome.

6.3. Environmental tobacco smoke

It is a self evident air pollutant from combustion that many people produce knowingly in the home, despite the warnings of adverse health effect. ETS is a mixture of more than 4000 compounds, at least 40 of which are carcinogenic and many of which are strong irritants. Indoors tobacco smoke can harm occupants as well as the smoker; ETS is also referred to as second hand or side stream smoke, and exposure to it is often called passive smoking.

The EPA of USA in 1992 concluded that exposure to ETS is responsible for about 3000 lung cancer deaths each year in non smoking adults.

In addition to second hand smoke, other sources of indoor combustion products include

- stoves
- space heaters
- fire places
- chimneys

Pollutants from these sources include, CO, NO₂, and particulate.

Kerosene space heaters may also emit SO₂ and acid aerosols.

Short term health effects of exposure to ETS:

- irritation of the eye, nose and throat
- aggravate asthma

6.4. Radon gas

Radon is colorless, odorless, radioactive gas that is the part of a natural decay process beginning with uranium and ending with lead.

Radon gas seeps in to homes from the soil, brick concrete and stone. It is believed to be produced from radioactive by product of stone and soil under the house. The level and effect of radon accumulation is very high in unventilated buildings. It is estimated in USA 10% of lung cancer deaths

may be attributed to radon gas exposure. Therefore radon is believed to be a carcinogen.

A simplified description of the sequence, along with half-lives, alpha, gamma, and beta radiation emitted. It is found in varying concentrations in soils and rocks that make up the earth's crust. Because it is the gas, radon flows easily through the porous soil and fissures in rock. When it reaches to the ground surface, the gas dispersed and diluted to very low concentrations in the out door environment.

Radon itself is inert, but it's short lived decay products (Radon progeny): polonium, lead and Bismuth, are chemically active and easily become attached to inhaled particles that can lodged in the lungs. In fact, it is the alpha emitting polonium, formed as radon decays, that causes the greatest lung damage.

Radon captured in the ground water , to be released when that water is aerated , such as during showers (the radon risk in water is from inhalation of the released gas, not from drinking the water itself) .A level of 10000 Pci/l of radon in water will produce about 1 pci/l of radon in indoor air.

Radon gas and its radioactive daughters are known carcinogens and may be the second leading cause of lung cancer after smoking. The EPA estimates that between 5000 and 20000 lung cancer deaths per year in the USA can attributed to household radon exposure

The degree of risk depends on:

- total exposure time
- average radon concentration in the home

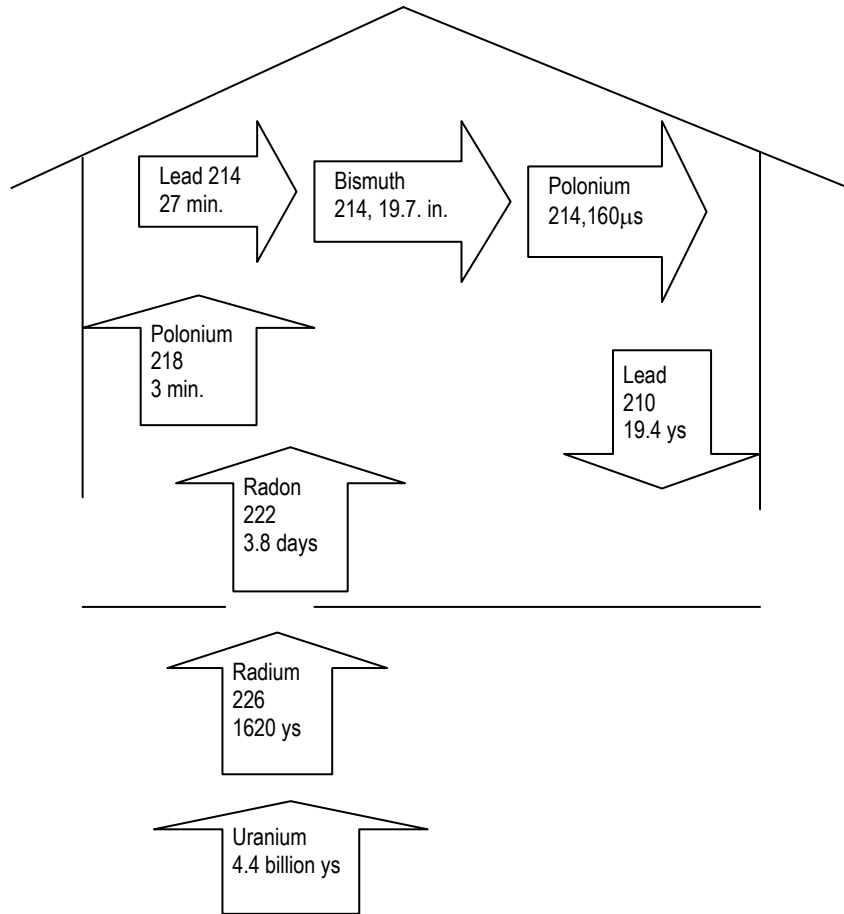

Table 6.1: estimated annual lung cancer deaths in United States, attributable to radon exposure, 1986.

Smoking history	Population (millions)	Lung cancer deaths	
		All cases	Radon attributable
Never smoked	145	5,000	500
Former smoker	43	57,000	6,400
Current light smoker *	38	37,000	4,500
Current heavy smoker	14	30,000	4,200
Total	241	130,000	15,700

*Less than 25 cigarettes per day

Source: Nazaroff and Teichman (1990)

6.5. Formaldehyde

Formaldehyde is an organic chemical widely used in the manufacture of many building materials and household products. It is also a by-product of combustion and may be present in significant amounts in indoor air. It is used, for example to add permanent-press qualities to drapes and other textiles, as a component of glues and adhesive, and as a preservative in some paints and coatings. Among the most significant household sources of formaldehyde are pressed wood products that are made using adhesives containing three formaldehyde (UF) tests. These include particle board and plywood paneling.

Formaldehyde is a colorless, pungent-smelling gas that cause eye and throat irritation, nausea, and respiratory distress in some people exposed to high concentrations. It has also been shown to cause cancer in animals and may cause cancer in humans, Average concentration in older homes (envisions generally decrease over time) are generally below 0.1 mg l m^3 , in homes with significant amounts of now pressed wood products, levels can exiled 0.3 mg /m^3 A suggested guideline is for elves not exceed 0.12 mg/ m^3 .

Formaldehyde emissions increase with to and humidity thus, the use of dehumidifiers and air conditioning can help reduce indoor concentrations. Increased ventilation rates also reduce formaldehyde resins rather than UF resins.

6.6. Asbestos

Asbestos used to be common building material formed in structural fire proofing, heating systems installation, floor and ceiling tiles and roofing felts and shingles. It has been also used in fires place, gloves, ironing board covers and certain hair driers.

6.7. Lead

Lead is a harmful environmental pollutant. People can be exposed to lead in drinking water and food, as well to lead dust in the air. The most significant sources of lead dust old

lead based paint is a particular threat to the health of children lead can become air borne in the have when lead based paint is improperly removed from suffices by scraping, sanding , or open flame burning .

At high leaves lead can cause convulsions, coma, and even death lower levels can adversely affect the brain, CNS, blood cells, and kidneys Infants and children are especially vulnerable because lead is more easily absorbed in to their bodies Harmful effects of lead in infants and children include delays in physical and mental development.

6.8. Carbon Monoxide

Carbon monoxide is produced primarily by the incomplete burning of fossil fuels, for example by cars and other gasoline-powered engines, and by charcoal or oil heaters. It is odorless and colorless, and because it is slightly heavier than air, it tends to collect in confined spaces and affect people without warning. The written history of carbon monoxide goes back many years, as Roman records discuss deaths associated with fires in enclosed spaces.

Basically, as carbon monoxide concentrations go up, the oxygen carrying capacity of the blood goes down disproportionately more, because oxygen molecules are literally being replaced by carbon monoxide molecules and the ability of hemoglobin to bind oxygen depends on O₂

binding at neighboring sites. The carbon monoxide molecule's bond to hemoglobin is 200 – 300 times stronger than is the hemoglobin- oxygen bond, so carbon monoxide is not cleared easily from the circulatory system. Exposure to short periods of high concentration of carbon monoxide is just as bad as long periods of low concentrations. Normal amounts of carbon monoxide in the blood are in the range of 1%. Smokers can have higher concentrations, and if one were to exercise at rush hour in heavy traffic (at 10-15 ppm), levels of 3 – 4% could be expected.

Table 6.2: Predicated Carboxyhaemoglobin Levels for Subjects Engaged in Different Types of Work

Carbon monoxide concentration		Exposure Time	Predicated COHb sedentary work	Level for those engaged in	
ppm	mg/m ³			light work	heavy work
100	115	15 minutes	1.2	2.0	2.8
50	57	30 minutes	1.1	1.9	2.6
25	29	1 hour	1.1	1.7	2.2
10	11.5	8 hours	1.5	1.7	1.7

Source: WHO, 1987a

Different predicated **carboxyhaemoglobin** levels for subjects engaged in different types of work are shown in Table 5.4 Different LOAELs (lowest-observed-adverse-effect-level) are shown in Table 2.7 Exercise tolerance does not seem to be decreased until after a level of about 5% is reached in healthy

subjects. People at increased risk include those with heart and lung problems. It has been found that “for every 1% increase in COHb (i.e. carbon monoxide molecule attached to a haemoglobin molecule) there was a 4% decrease in time to ischaemic changes” (Folinsbee, 1992). At low levels, symptoms of CO exposure include fatigue, headaches and dizziness, but higher concentrations can lead to impaired vision, disturbed coordination, nausea and eventually death.

To prevent carboxyhaemoglobin levels from exceeding a 2.5% to 3% level in the non smoker, the following guidelines were proposed: a maximum permitted exposure of 100 mg/m³ for less than 15 minutes; 60 mg/m³ (50 ppm) for less than 30 minutes; 30 mg/m³ (25 ppm) for less than 60 minutes and 10 mg/m³ (9 ppm) for 8 hours (WHO, 1987a).

Table 6.3: Human Health Effects Associated with Low-Level Carbon Monoxide Exposure: Lowest-Observed-Adverse-Effect Levels Carboxyhaemoglobin effects Concentration (%)

2.3 – 4.3	statistically significant decrease (3-7%) in the relation between work time and exhaustion in exercising young healthy men
2.9 – 4.5	statistically significant decrease in exercise capacity (i.e. shortened duration of exercise before onset of pain) in patients with angina and increase in duration of angina attacks
5 – 5.5	statistically significant decrease in maximal oxygen consumptions and exercise time in young healthy men during strenuous exercise
< 5	No statistically significant vigilance decrements after exposure to carbon monoxide
5 – 7.6	statistically significant impairment of vigilance tasks in healthy experimental subjects
5 – 17	Statistically significant diminution of visual perception, manual dexterity, ability to learn, or performance in complex sensorimotor tasks (e.g. driving)
7 – 20	Statistically significant decrease in maximal oxygen consumption during strenuous exercise in young healthy men

Source: WHO, 1987a

6.9. Biological Contaminants

Airborne contaminants of a biological nature include bacteria fungi viruses' animal dander, dust mites, pollen, and other tiny forms or products of life. There are many sources of these biological pollutants contaminated central heating or cooling systems can become breeding grounds and the distribute these contaminants throughout the home standing water - water damaged materials or wet surfaces can also serve as breeding grounds .

Allergic reactions such as asthma and rhinitis can be triggered by many biological contaminants in sensitive people. Infectious diseases, such as influenza measles and chicken pox can be transmitted through the air, and some fungi release disease causing toxin that can become air borne. The deaths from legionnaires disease of 29 visitors at a convention in Philadelphia Hotel in 1976 is a notable example of the potential hazards. The hotels ventilation system had nurtured the bacteria legionnela.

By controlling the relative humidity level in a home, growth of some types of biological contaminants can be minimized; a relative humidity between 30 and 50 percent is generally recommended kitchen and bath room exhaust fans vented to the out doors will help to eliminate moisture that builds up from every day activities. Naturally, keeping a house clean will also help reduce air borne biological contaminants particularly

house mites, animal dander, pollen and other allergic causing agents.

6.10. Building materials, furniture's and Chemical products

A wide variety of household products contain formaldehyde and other hydrocarbons. These include foam insulation floor covering (carpet) and textile products, furniture polish disinfections etc.

6.11. Sick Building Syndrome (SBS)

Indoor air pollution is not limited to individual homes many multistory commercial and office buildings have significant air quality problems. A number of well identified illnesses (for example Legionnaire's disease) have been directly traced to specific building problems. Three are called building related illnesses.

When the occupants of building have symptoms that do not fit the pattern of any particular illness and are difficult to trace to a specific source, the phenomenon is referred to as trace to specific source, the phenomenon is referred to as sick building syndrome. This term is applied to building when more than 20 percent of its occupants complain of health problems for 2 weeks or more and the symptoms are relieved when the

occupants leave the building. It is estimated that as many as 30 percent of new or remodeled commercial buildings experience sick building syndrome. Health complaints typically include sneezing, fatigue, headache, dizziness, nausea, dry throat, and irritability.

Air pollution sources in commercial buildings are similar to those found in the home. One major cause of sick building syndrome is poor design, operation, or maintenance of the complex mechanical ventilation system needed to heat, cool, and circulate air throughout a large building.

Ventilation problems arise when, in an effort to save energy, inadequate amounts of outdoor air are exchanged with indoor air. Problems also may occur if air supply and return vents with each other are blocked or placed improperly. In the wrong locations, outdoor air intake vents can bring in automobile exhaust, boiler emissions, or even air wanted from restrooms. The ventilation system itself can be a source of air pollution, spreading microbes that thrive on the inside surfaces of ductwork, as well as in humidifiers, dehumidifiers, and air conditioners. Finally, air pollutants can be circulated into offices from restaurants, print shops, and dry cleaning stores located in the same building, as well as from underground parking garages.

Sick building syndrome usually can not be effectively remedied without a comprehensive air quality survey and investigation. These investigations may begin with questionnaires and telephone interviews to assess the nature and extent of occupant symptoms. The ventilation system is often the most important factor to investigate; inadequate ventilation accounts for about half of sick building syndrome cases. Air quality testing may help to identify contaminants, but air sampling and analysis are not always effective in solving the problem due to the very low levels of pollutants.

Table 6.4: Sources and exposure guidelines of indoor air contaminants

Pollutant and indoor sources	Guidelines, average concentrations
<p><i>Asbestos and other fibrous aerosols</i></p> <p>Friable asbestos; fireproofing, thermal and acoustic insulation, decoration, Hard asbestos: vinyl floor and cement products.</p>	0.2 fibers/ml for fibers longer than 5 μm
<p><i>Carbon monoxide</i></p> <p>Kerosene and gas space heaters, gas stoves, wood stoves, fireplaces, smoking.</p>	10 mg/m ³ for 8 hr, 40 mg/m ³ for 1 hr
<p><i>Formaldehyde</i></p> <p>Particleboard, paneling, plywood,</p>	120 $\mu\text{g}/\text{m}^3$

carpets, ceiling tile, urea-formaldehyde foam insulation, other construction materials.	
<i>Inhalable particulate matter</i> Smoking, vacuuming, wood stoves, fireplaces	55-110 $\mu\text{g}/\text{m}^3$ annual, 150-350 $\mu\text{g}/\text{m}^3$ for 24 hr
<i>Nitrogen dioxide</i> Kerosene and gas space heaters, gas stoves.	100 $\mu\text{g}/\text{m}^3$ annual
<i>Ozone</i> Photocopying machines, electrostatic air cleaners	235 $\mu\text{g}/\text{m}^3/\text{hr}$ once a year
<i>Radon and radon progeny</i> Diffusion from soil, ground water, building materials	0.01 working levels annual
<i>Sulfur dioxide</i> Kerosene space heaters	80 $\mu\text{g}/\text{m}^3$ annual, 365 $\mu\text{g}/\text{m}^3$ 24 hr
<i>Volatile organics</i> Cooking, smoking, room deodorizers, cleaning sprays, paints, varnishes, solvents, carpets, furniture, draperies.	None available

Source: Nagda et al. (1987).

6.12. Indoor air pollution in relation to developing countries

Indoor-air pollution in the context of developing countries

About **3.5 billion people** in less developed countries, still rely on biofuels (wood, dung and crop residues) for domestic energy [WRI 98]. Fuels are typically in open fires or simple stoves, often indoors, and rarely with adequate ventilation or chimneys. This situation leads to some of the highest ever recorded levels of air pollution, to which young children and women in particular are exposed for many hours each day [Smith 87, Smith 93].

Although smoke from biofuels contains thousands of substances, many of which may be harmful to health, it is particulates that are thought to best describe the health-damaging potential of this pollution. Particles are defined by their diameter, expressed in microns. Smaller particles of less than 10 microns (PM_{10}) are thought most harmful due to their ability to penetrate into the lungs. Concentrations are expressed as the weight of PM_{10} ($\mu g/m^3$) of air sampled. Current US EPA recommendations are that average 24 hour PM_{10} levels should exceed $150 \mu g/m^3$ only once in 100 occasions (99th percentile level), and that the annual average should not exceed $50 \mu g/m^3$. The revised World Health

Organization air quality guidelines for Europe, reflecting the growing evidence that there appears to be no safe lower limit for particulate exposure, has not recommended 'levels' of PM₁₀. Instead, exposure-response data for mortality, respiratory symptoms, and service use are presented. Given this ever more cautious attitude towards particulate air pollution in the developed world, it is striking that typical 24 hour average PM₁₀ concentrations in developing country households using an open fire are around 1000 µg/m³ or more, and that during cooking average particulate concentrations in these homes are therefore at least 20 times higher than levels at which important health outcomes are being detected.

WHO has estimated that around 75% of the total global burden of exposure to particulate air pollution is experienced indoors in developing countries: 50% in rural areas, and 25% in cities [WHO/EHG 97]. Whilst these figures are not disaggregated by age, it is known that young children are at high risk of exposure, because they are usually with their mothers in the kitchen. This global distribution of exposure is in striking contrast to the focus of attention and resources for research and policy on air pollution, which has been largely directed on the outdoor environment of cities in the developed world.

Threat to children's health

Dependence on polluting solid fuels to meet basic energy needs represents one of the biggest threats to children's health. 56% of deaths and more than 80% of DALYs lost due to solid fuel use fall on children under five years of age. Acute lower respiratory infections, in particular pneumonia, continue to be the biggest killer of young children and cause more than 2 million annual deaths. This toll almost exclusively falls on children in developing countries.

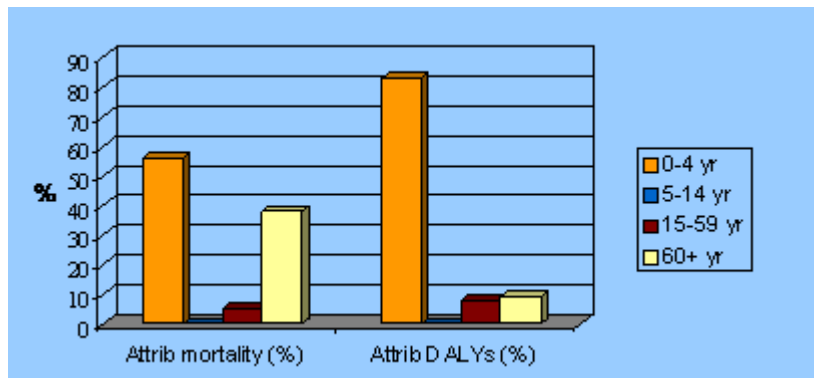

Attributable mortality and DALYs lost due to indoor air pollution by age group - 2002

Evidence linking IAP exposure with acute lower respiratory infections (ALRI)

Around twenty observational studies examining the association between IAP exposure and fairly well defined

ALRI have now been published. The studies reporting positive results indicate an increase in risk of ALRI for exposed children of between 2 and 5 times. Although this suggests that reducing IAP exposure could be a powerful preventive intervention for ALRI [Kirkwood 95], there remain important gaps in our knowledge:

- The size of any effect on ALRI incidence is uncertain, which in turn means there is uncertainty about the potential that reduced IAP exposure has for prevention of ALRI.
- The exposure-response relationship has not been quantified, with the result that it is not known by how much exposure needs to be reduced in order to achieve useful health gain. This has important implications for implementation because there are currently **substantial technical and economic barriers** to achieving large reductions in exposure among many poor communities for whom pollution is worst.

Disease burden by level of development

The importance of indoor air pollution as a public health threat varies drastically according to the level of development: in high-mortality developing countries, indoor air pollution is responsible for up to 3.7% of the burden of disease, while the

same risk factor no longer features among the top 10 risk factors in industrialized countries.

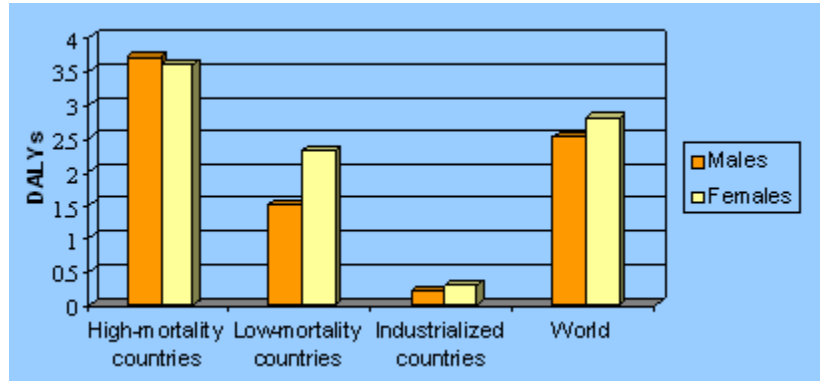

Disease burden (DALYs) due to indoor air pollution by level of development - 2002

WHY DOES THE BURDEN PERSIST?

There are a number of reasons why the burden on child health associated with IAP persists, and these can be broadly summarized as follows:

- The limitations of the scientific evidence on causation.
- There are technical and economic barriers to achieving substantial exposure reductions, especially in poor communities.
- The 'cross-cutting' nature of the problem and the interventions required, typically involving a range of

technical, community and policy options, and collaboration between organizations and agencies responsible for **health, energy, housing and development.**

Interventions

The following interventions may be used alone or in combinations to reduce exposure to IAP

Technical interventions

- Smoke removal - Flues attached to stoves, hoods and chimneys to remove smoke.
- Other stove improvements - Stove improvements that reduce emissions, through better combustion and/or more efficient heat transfer.
- Housing design - Changes to kitchen design to increase ventilation and control the distribution of pollution.
- Fuels - Methods of cleaning existing fuels, for example bio-gas and other "clean" bio-mass products, or promoting fuel-switching to alternatives such as kerosene, LPG or electricity.

Behavioral interventions

- Promoting awareness of long-term health effects on the part of users. This may lead to people finding ways of minimizing exposure through e.g. better kitchen management.

- Infant protection - Keeping children away from smoke exposure.

Policy level interventions

- Fuel pricing - To encourage the use of cleaner fuels.
- Other forms of financial assistance and development - subsidizing cost of appliances, local micro-credit facilities for durable higher quality devices, income generation opportunities (for example, through tree nursery development).

Domestic Fuel Shortage and Indoor Air Pollution

The obligation to provide both water and fuel for domestic use, particularly in conditions of increasing environmental degradation, is a massive burden on poor urban and rural women and girls. In addition, the health effects of domestic use of biomass fuels (wood, dung, agricultural residues) and coal are suffered largely by women. Important issues can be summarized as follows:

- Women are hit hardest by shortage of fuel, since the onus is on them to find solutions.
- Household coping strategies can affect nutritional status since fuel availability affects cooking habits and food availability.
- Better understanding is needed of the health impact of restricting poor communities access to natural resources.

- The linkages between fuel, food, water, women's time and women's health warrant further exploration.
- Dung-work illustrates the linkage between women's work and their status.
- Where biomass fuels are commonly used, similar rates in women and men are now being found for diseases such as chronic bronchitis and *cor pulmonale*; age of onset of *cor pulmonale* in women is early.
- Women's respiratory disorders in India are linked to domestic exposure to cooking smoke; however, respiratory disease in women often goes untreated.
- Undetected pneumoconiosis in rural women may be caused by a combination of dust from maize grinding and smoke from biomass fuel.
- High lung cancer rates in Chinese women can be attributed to the combined effects of passive smoking and the domestic use of poor quality coal.

DEVELOPMENT REPORT - WHO/Air Pollution

The United Nations World Health Organization says millions of people die earlier than they should because of indoor air pollution. It says most victims live in developing countries. Dietrich Schwela is a pollution scientist for the W-H-O. Mr. Schwela says people need to be informed about the dangers of indoor air pollution. He says many people do not know that

the air found in buildings can injure and sometimes kill. The WHO scientist says indoor air pollution is common in developing countries because people there use open stoves. They cook food on the stoves. And, the devices produce heat for their homes.

Mr. Schwela says that many houses in developing countries do not use chimneys. Chimneys are tall, narrow structures with an opening at the top. They usually are made of building materials or metal. The opening of the chimney should rise through the top of the building. A fire can be built at the bottom of the chimney. Chimneys permit smoke to travel up and out of the house. They protect people in the house from breathing in much of the smoke. Mr. Schwela says chimneys in developing countries often are not built correctly. He says this is especially true in African nations. The W-H-O scientist says chimneys there often end one or two meters below the top of the house. This means the smoke travels up and then around the inside of the building.

Mr. Schwela says such buildings have air with very small and dangerous pieces of matter, such as dust and ash. This can cause breathing disorders, lung cancer, and diseases of the heart and lungs.

Mr. Schwela says women and small children are most at risk. That is because they spend more time in the house than adult males. The W-H-O estimates that five-hundred-thousand

children in India die each year from indoor air pollution. In Africa, about that many children die from the problem.

Mr. Schwela advises people not to use open stoves. He says they also should not use wood and some other natural fuels inside buildings. Mr. Schwela says natural gas and kerosene are much better fuels for cooking and heating. And, he says people should have working a chimney that sucks smoke out of the house.

HEALTH EFFECTS OF WOOD SMOKE

In developing countries, woodsmoke has had a serious effect on human health as some wood stoves emit smoke to indoor air.

In Sydney, studies by the NSW EPA found that most of the particulate pollution in winter came from 13% of households using wood heaters. Studies also showed that death rates are generally higher in winter on days of high pollution, or days following high particle pollution.

Wood smoke is estimated to be 12 times more carcinogenic than an equal concentration of cigarette smoke'.

In a laboratory study, mice were subjected to either wood smoke; oil furnace fumes or clean air for 6 hours. They were then challenged with a streptococcus bacterium and within two weeks, 21% of the mice exposed to wood smoke were

dead compared with 5% of the mice exposed to the oil furnace fumes or clean air.

Autopsies have shown that particles less than 2.5 microns in diameter (PM2.5) are retained in human lungs. Larger particles are not retained.

The following can be caused by wood smoke:

- obstructive airway disease
- reduced lung function
- asthma, wheezing, cough
- higher incidence of bacterial infections
- cataracts
- eye lens opacification
- bronchiolitis
- otitis media (ear inflammation)
- methemoglobinaemia (reduced oxygen in blood)
- cancer
- sore throats
- migraine
- pneumonitis
- fibrosis of the lungs
- unnecessary deaths

6.13. Exercise questions

1. What is the difference between indoor and outdoor air pollution?
2. What are the common types indoor air pollutants in your community?
3. Do you think that indoor air pollution as a significant health problem than outdoor air pollution in Ethiopia? If so, how?
4. List some of the general measures of controlling indoor air pollution.

CHAPTER 7

RISK ASSESSMENT

7.1. Learning Objective

After the completion of this chapter, the student will be able to:

1. Define the elements of risk assessment;
2. Understand the types of information needed for each element of risk assessment;
3. Describe how hazards can be identified in the field;
4. Describe the types of extrapolation required for the assessment of dose-response;
5. Explain the difference between threshold and non-threshold effects;
6. Provide several examples of useful markers of exposure;
7. Illustrate the difference between direct and indirect approaches of exposure assessment;
8. Describe potential. Errors in environmental sampling.

7.2. Introduction to the chapter

The ultimate goal of studying the relationship between environmental hazards and health is to do something to reduce or eliminate those hazards. This is called risk

management. But before anything can be done the risks must be identified and thoroughly evaluated. This process of evaluating the possible effects on people of exposure to substances and other potential hazards is known as risk assessment.

7.3. The health risk assessment and risk management framework

Risk assessment has its limitations. In practice, crucial data are frequently lacking. Reasonable assumptions are made to arrive at *quantitative risk estimation*. Several of the many sources of uncertainties that may accompany a risk assessment are listed in Table 7.1. Most risk assessments contain one or more of these and it is essential to evaluate their impact on the assessment. This process is usually referred to as sensitivity analysis and may be quite complex. In many situations, only a *qualitative risk assessment* may be appropriate. In view of the specific skills required to judge and interpret all available data, risk assessment is often considered to be more of an art than a science. The steps in risk assessment are shown in figure 7.1.

Table7.1. Several of the Many Sources of Uncertainty in a Risk Assessment

-
- Use of an experimental study involving an inappropriate route of exposure;
 - Differences in biokinetics and/or mechanism of toxicity between species;
 - Poor specification of exposure in experimental study i.e. concentration, duration, route, chemical species;
 - Extrapolation high dose to low-dose situations;
 - Difference in age at first exposure or life-style factors between an experimental group and a risk group;
 - Exposure to multiple hazards in epidemiology studies;
 - Potential confounding factors;
 - Misclassification of the health outcome of concern.
-

Adapted from Hallenbeck, 1993

When the health risk of a specific environmental hazard or situation has been characterized, decisions must be made regarding which of the various control actions should be taken. Regulatory agencies may develop regulatory options, evaluate the consequences (public health, economic, social and political) of the proposed options, and/or they may implement the agency decisions.

7.4. Epidemiological methods

The science of epidemiology was briefly introduced in chapter 1. Data from epidemiological studies may be used directly to identify hazards and characterize dose-response relationships. The types of studies used in epidemiology each have their own benefits and limitations.

7.4.1. Steps in Epidemiological Field Investigations

A framework of epidemiological concepts and techniques where by environmental health investigations may be carried out logically is presented in Figure 7.2.

The aim of analytical studies is to determine if any environmental factors (or other risk factors) are indeed associated with the problem (or outcome of interest). Alternatively, enough data may exist to warrant implementing controls. The follow-up then would be to determine if control of the suspected environmental hazard does indeed reduce morbidity or mortality. An on-going surveillance problem may be required to monitor progress and to identify changes in the pattern of the disease outcomes or causes.

A number of different types of epidemiological studies may be used for formal testing of hypotheses. These are discussed below.

7.4.2. Study Methods

Epidemiological study types differ considerably in their strengths and weaknesses. Table 7.2 summarizes the main features of the major traditional types of epidemiological studies.

There are only so many ways to study the association between a cause and a disease, injury or other health condition. One may see what the situation is at the time of the study. One may start with the cause and see what happens over time. One may start with the condition and try to determine what might have caused it in the past. To do any of this, one may study subjects with knowledge of them as individuals or one may study only large groups with only information on the group. One may or may not try to change things and see what happens. Once these various combinations are put together, they pretty well describe what is possible in epidemiology.

Table 7.2. Study Designs in Environmental Epidemiology That Use the Individual as the Unit of Analysis

Study design	Population	Exposure	Health effect	Confounders	Problems	Advantages
Descriptive study	Community or various sub-populations	Records of past measurements	Mortality and morbidity statistics; case registries; other reports	Difficult to sort out	Hard to establish exposure-effect relationships	Cheap, useful to formulate hypotheses
Cross-sectional study	Communities or special groups; exposed vs. non-exposed	Current	Current	Usually	Current	Can be done quickly; can use large populations; can estimate prevalence
Prospective cohort study	Community or special groups; exposed vs. non-exposed	Defined at outset of study (can change during study)	To be determined during study	Usually easy to measure	Expensive, time consuming exposure categories can change; high dropout rate possible	Can estimate incidence and relative risk; can study many diseases in one study; can describe associations that suggest cause-effect relationships

Historical cohort study	Special groups e.g. workers, patients, insured persons	Records of past measurement	Records of past or current diagnosis	Often difficult because of retrospective nature; depends on disability of previously obtained data	Need to rely on records that may not be accurate	Less expensive and quicker than prospective study; can be used to study exposures that no longer exist
Case-control study	Diseased (cases)vs. non-diseased (control)	Records or interview	Known at start of study	Possible to eliminate by matching	Difficult to generalize; may incorporate biases; cannot derive rates	Relatively cheap and quick; particularly useful for studying rare diseases
Experimental (intervention study)	Community or special groups	Controlled /known already	To be measured during study	Can be controlled by randomization of subjects	Expensive; ethical consideration; study subjects' compliance required	Well accepted results; strong evidence for causality or efficacy or intervention

Source: WHO, 1991a

An Approach to classification of studies designs

Table 7.3 provides a framework for analyzing both historical and prospective cohorts' studies according to four sets of criteria. These criteria address defining the study cohort, quantifying exposure, ascertaining mortality, and analyzing results. The definition of a study cohort is in turn evaluated according to the method of cohort selection, criteria for inclusion or exclusion of cohort members, the extent to which the subjects selected for study included all eligible workers, and the adequacy of the size of the cohort. Similarly, quantifying exposure will take into account the amount of detail contained in work history files, the extent of industrial hygiene data, the quality of industrial data, and whether there is a likely impact of any confounding factors. With respect to ascertaining mortality, it is necessary to consider the quality of the follow-up (i.e. the method employed to determine whether subjects are alive or dead at the end of a study), the completeness of the follow-up procedure, the availability of death certificates or other records that list causes of death, and the length of the follow-up period. Finally, analysis of results depends on the appropriateness of the external control group employed in the study, the availability of an internal control group, whether the study takes into account the delay, or latency periods associated with disease development, the use of appropriate statistics, demonstration of an exposure gradient, and a discussion of possible sources of bias. These

factors are discussed at length in various epidemiological publications.

Table 7.3. Assessing the Quality of Historical Cohort Studies

-
1. Definition of the Study Cohort
 - (a) Method of selection
 - (b) Criteria for inclusion or exclusion
 - (c) Extent to which all cohort members were considered
 - (d) Size of the cohort
 2. Quantification of Exposure
 - (a) Detail in work history files
 - (b) Extent of industrial hygiene data
 - (c) Quality of industrial hygiene data
 - (d) Consideration of confounding factors
 3. Ascertainment of Mortality
 - (a) Quality of follow-up technique
 - (b) Completeness of follow-up
 - (c) Availability of death certificates or other records to determine the cause of death
 - (d) Length of follow-up

4. Analysis of Results
 - (a) Suitability of the external control group
 - (b) Availability of an internal control group
 - (c) Allowance for latency effects
 - (d) Use of appropriate statistics
 - (e) Demonstration of an exposure gradient
 - (f) Discussion of possible biases
-

Source: ACOHOS, 1983

7.4.3 Quantifying Risks

There are a few standard equations used in epidemiology to determine if the study population is at an increased risk or has an increased number of cases of the disease in question compared to a standard population.

To determine if the observed rate is excessive, a **risk ratio**, or **relative risk** should be calculated. This is shown in Figure 7.1 these are usually calculated from cohort studies. Data from case-control studies approximate the relative risk by a calculation known as an **odds ratio**.

Figure 7.1: Definition and Calculation of Rates of Disease and Risk Ratios

RATE OF DISEASE:	$\frac{\text{Number of cases of disease in population at risk}}{\text{Number of persons in population at risk}}$
EXPRESSED AS:	Number of cases 100 or 1000, etc. persons at risk
EXAMPLE:	$\frac{50 \text{ cases}}{2500 \text{ persons at risk}} = \frac{20}{1000}$
RISK RATIO:	$\frac{\text{Rate of disease in population with the risk factor}}{\text{Rate of disease in population without the risk factor (comparison population)}}$
EXPRESSED AS:	A numerical ratio (1.5,3.0 etc. indicating that risk of disease in the exposed (or at risk) population is 1.5,3.0, etc. times greater than that in the unexposed (or not at risk) population
EXAMPLE:	$\frac{20/1000}{10/1000} = 2.0$

A risk ratio of 1.0 means that the rate of the problem (or outcome of interest) in the group being studied is not different from the rate of the problem in the general population. A risk ratio of greater than two or three is usually considered important. For example, a risk ratio of five would mean that

the populations with the risk factor (e.g. those who are exposed to asbestos) are five times more likely to have or get the disease (e.g. lung cancer) than the population without the risk factor (e.g. those who were not exposed to asbestos).

A **risk ratio** is the most widely used form of risk measure. It is defined as “the ratio of the risk of disease or death among the exposed to the risk among the unexposed”. Other measures of risk, which can be derived from epidemiological studies, are defined in Box 7.1. The **risk difference** is “the absolute difference between two risks”. It demonstrates the excess risk of the health problem in the exposed population. This is also known as the **incremental risk**. The **attributable fraction (exposed)** describes the proportion of new cases of a disease in the exposed population due to the exposure, i.e. “the proportion by which the incidence rate of the outcome among the exposed would be reduced if the exposure were eliminated”. The **attributable fraction (population)** describes the proportion of new cases of a disease in the whole population due to the exposure, i.e. “the proportion by which the incidence rate of the outcome among the entire population would be reduced if the exposure were eliminated”.

BOX 7.1

Common Measures of Risk Derivable from Epidemiological Studies

$$\text{Risk Difference} = E - U$$

$$\text{Risk Ratio} = \frac{E}{U}$$

$$\text{Attributable Fraction (Exposed)} = \frac{E-U}{E} = (\text{through mathematics}) \frac{RR-1}{RR}$$

$$\text{Attributable Fraction (Population)} = \frac{I-U}{I} = \frac{[p(RR-1)]}{[p(RR-1)+1]}$$

Where U = incidence (or mortality) in the unexposed group;

E = incidence (or mortality) in the exposed group;

P = prevalence in the total population;

I = incidence in the total population;

RR = Risk Ratio

Odds ratio (OR) can be calculated as follows (2 x 2 table) :

		Disease	
		Yes	No
Exposed	Yes	A	B
	No	C	D

$$\text{OR} = \frac{AD}{BC}$$

The most frequently employed method of evaluating mortality in an occupational epidemiological study is to calculate the **standardized mortality ratio (SMR)** for the group. The SMR is the ratio of the observed deaths in a group divided by the number of deaths that would normally be expected in a group with a similar age distribution.

$$\text{SMR} = \frac{\text{Observed number of deaths (or events) in the study population} \times 100\%}{\text{Expected number of deaths (or events) if the study population had the same age and gender composition as the comparison (e.g. national) population}}$$

The denominator of the SMR (e.g. the expected number of deaths) is computed as follows:

1. A calculation is made of the person-years at risk in the cohort (the number of individuals in the cohort multiplied by the number of years that each individual has been followed).
2. The figure obtained is multiplied by the expected mortality rate for the disease(s) being considered. The expected mortality rates can be obtained from national population statistics.

An SMR of 130 for a particular cause of death indicates that there was a 30% greater mortality of that disease found than was actually expected.

Since these measurements of risk are statistical, we can not be sure that the observations in a study did not occur by chance. The statistical significance of these measures are

usually expressed in a **confidence interval**. For example, if a number falls within a 95% *confidence interval*, one can be 95% sure that the ratio is correct. That also means that there is a 5% chance that the study's results occurred by chance. The width of the confidence interval depends on the number of cases observed, the size of the population in the study, and the variability of the comparison or expected rates. These issues are discussed at greater length in *Basic Epidemiology*, *Environmental Epidemiology*, and other WHO publications.

7.4.4. Study Difficulties and the Determinants of Causation

Some form of analytical epidemiological study is usually necessary to establish the cause of a disease, although descriptive studies can give a strong indication of causation at times. The choice of study depends on the particular situation. It will vary according to the nature of the disease in question, its frequency in the population, the frequency of postulated risk factors, the availability of resources, the experience and preference of the environmental health professionals available, among other things. (See publications such as *Environmental Epidemiology*, WHO, for more details.)

In determining the degree of weight that should be placed on the evidence obtained from an epidemiological study, it is necessary to distinguish between the concepts of **association** and **causation**. A causal relationship implies that the disease has been shown to be actually induced by the environmental agent. There are numerous reports in scientific literature alleging links between environmental agents and disease outcome. Therefore, guidelines are needed to assess the likelihood that the association is a cause-and-effect relationship. The most widely accepted were originally conceived by British statistician Sir Austin Bradford Hill, and are shown in Table 7.4. These guidelines are not absolute, but are useful in achieving consensus about whether a known risk factor is likely a true cause of the disease in question.

Table 7.4: Tests of Causation

-
- Temporal relation: Does the cause precede the effect? (essential)
 - Plausibility: Is the association consistent with other knowledge?
 - Mechanism of action: Is there evidence from experimental animals?
 - Consistency: Have similar results been shown in other studies?
 - Strength: what is the strength of the association between the cause and the effect? (relative risk)
 - Dose-response relationship: Is increased exposure to the possible cause associated with increased effect?
 - Reversibility: Does the removal of a possible cause lead to reduction of disease risk?
 - Study design: Is the evidence based on a strong study design?
 - Judging the evidence: How many lines of evidence lead to the conclusion?
-

Source: Beagle Hole *et al.*, 1993

The main weakness of epidemiological studies about environmental pollutants is that they are relatively inefficient in proving that exposure to a particular substance is associated with the health effects observed. A major limitation of most studies is the statistical possibility that a real association will not be detectable in the study. For example, in order to detect a two-fold increase in major congenital malformations (with 95% certainty that an increase found was not a chance finding, i.e. $\alpha=0.05$; $\beta=0.20$), more than 300 live births would have to be studied, as shown in table e.5.

7.5. Hazard identification in the field

Based on toxicological and epidemiological data, potential health effects of hazardous substances can be indicated. These research methods applied to identify environmental hazards have been introduced. However, recognizing hazards in a specific situation requires a different approach. More often, it is done by monitoring purchases of toxic substances and by conducting **health hazard evaluations and hazard audits**, both of which involve walking through the plant (or community facility) and investigating all operations. The difference between the two is that in a health hazard evaluation the **walk-through** is intended to identify the cause of a particular problem but in a hazard audit all potential hazards are systematically examined.

7.5.1. Occupational Environment

In the workplace it can be relatively easy to make an inventory of all potential hazards. This is made easier by an accurate registration or tracking system of all chemicals that are frequently used or stored, which unfortunately is not always the case. In order to make an inventory of chemical hazards, product identity is, of course, crucial. From knowledge of which product is used one may then learn what is in it and what constituents are hazardous. Identifying the chemicals in a product may be difficult if the manufacturer is not required by law to list ingredients, or if the material is not labeled properly, or if the composition of the product is protected as a trade secret.

7.5.2. General Environment

In contrast to the occupational environment, the identity of chemical hazards is usually difficult in uncontrolled environments, such as illegal dumping sites or abandoned industrial locations. For example, the chemical hazards at a suspected soil contamination may be almost anything. One way is to check whether there is information within the community regarding former industrial or other activities at the suspected location. Based on the results of such an inquiry further research can be streamlined in a specific direction. However, if no records exist or no industrial activities can be

described by former workers, the situation becomes far more difficult. In such a situation, chemical analysis of samples will have to be conducted to determine the nature of the contamination. Since it is too costly to screen for all possible contaminants, chemical analysis has to be concentrated on specific *marker* components.

7.6. The relationship between dose and health Outcome

7.6.1. Dose-Effect and Dose-Response Relationships

The terms 'dose-response' and 'dose-effect' are often used as being the same in meaning. Strictly speaking, however, dose-response relationship describes the relationship between the proportion of individuals in an exposed group that demonstrate a defined effect, and the dose. A dose-effect relationship describes the relationship between the severity of a health effect and the dose.

A hierarchy of effects on health can be identified for most hazards, ranging from acute illness and death to chronic and lingering illnesses, from minor and temporary ailments to temporary behavioral or physiological changes, as shown in Table 7.5.

Table 7.5: Range of Effects on Human Health Due to Environmental Exposure

-
- Premature death of many individuals
 - Premature death of any individual
 - Severe acute illness or major disability
 - Chronic debilitating disease
 - Minor disability
 - Temporary minor illness
 - Discomfort
 - Behavioral changes
 - Temporary emotional effects
 - Minor physiological change
-

Dose-response relationships are considerably different for non-carcinogens (thought to have a threshold) and carcinogens (thought to be non-threshold) as discussed further below.

7.7. Human exposure assessment

7.7.1 Options in Approach

Human exposure is defined as the opportunity for absorption into the body or action on the body as a result of coming into contact with a chemical, biological or physical agent. The various routes of exposure have already been introduced. The units of exposure to a chemical are usually concentration multiplied by time (e.g. mg/ml/hr). The term total exposure implies that an attempt is being made to take into account all exposures to the contaminant regardless of media or route of exposure.

The critical parameter with respect to health is actually the dose, since it directly identifies the amount of the contaminant that has the potential to attack the target organ. (This can be made even more specific. Internal dose refers to the amount of the contaminant absorbed in body tissues upon inhalation, ingestion or absorption. Total dose is the term used to indicate the sum of all doses received by a person of a contaminant over a given time interval from interaction with all media.

As dose is difficult to measure, the parameter usually considered is the exposure. Therefore, regulators usually establish rules and regulations which are directly linked to

reducing exposure, as opposed to dose. Estimates can then be made of the dose, based on the exposure, various assumptions, and animal models. While such estimates often have large uncertainties, it is a more practical parameter than dose. In any case, it has to be clear that measuring exposure, it is a more practical parameter than dose. In any case, it has to be clear that measuring exposure, not concentration, is the critical parameter since it is more directly related to health effects. To put it simply, if someone is not inhaling, ingesting, or absorbing the pollutant there is no exposure and hence no health effect. It should therefore be stressed that in all investigations the measurement of exposure be assessed and not just concentration. Exposure is usually considered for just one medium at a time. However, any risk assessment which is intended to maximize mitigation strategies must establish the relative risks from all media and routes of entry.

Environmental monitoring measures concentrations of contaminants to which individuals may be exposed. Biological monitoring usually measure dose. Each of these can be further subdivided. Area sampling measures concentrations without taking into account the extent of actual exposure, while personal sampling more directly measures the concentrations to which an individual is exposed throughout a period of time. Similarly, biological monitoring can also be further subdivided in a way that reflects extent, to which the biological marker being sampled is a measure of dose, a

marker of effect, or a marker of susceptibility. Exposure markers are of greatest interest to regulators and those charged with the need to control exposures. Clinicians are generally more interested in markers of health or susceptibility. The marker of most interest to epidemiologists depends on the nature of the epidemiological study.

7.7.2. Personal Exposure Monitoring

Personal air monitoring devices provide direct measurements of concentrations of air contaminants in the breathing zone of an individual. Generally, samplers worn by subjects record time-integrated concentrations or they collect time-integrated samples. These may be devices that read concentrations directly (in the case of the former) or ones that require lab analysis (as is generally the case in the latter). Samplers may be either active (requiring a pump to move air) or passive (require no pump and collect the airborne contaminant by diffusion).

With respect to waterborne contaminants, a direct measurement entails sampling from the water source, like a drinking tap, or from the water actually drunk. With respect to food, duplicate meals are analyzed. In this method, an individual must collect a second portion of everything consumed. This duplicate meal is then homogenized and analyzed for the compounds of interest.

Direct measurements of skin exposures in an occupational environment have been established by attaching patches on the skin. After a working day, the patches can be removed, extracted and analyzed. The effectiveness of using gloves to protect skin exposure can be established in a comparable way. Cotton gloves worn underneath latex gloves can be analyzed for specific chemical agents after handling. The results would indicate whether and to what extent the compound of interest can penetrate the gloves. Based on these results, it can be indicated how frequently gloves should be changed in order to prevent exposure.

7.7.3..Biological Monitoring

In biological monitoring, the contaminant of interest, its metabolite or the product of interaction between it and some target molecule or cell is measured in the relevant body tissue. If lead is the contaminant of interest, for example, area sampling can be conducted to determine the operations associated with the greatest lead concentration; personal air monitoring for lead exposure may be conducted; blood lead levels may be drawn on exposed workers to measure dose; or a marker of effect such as free erythrocyte protoporphyrin (FEP) may be evaluated.

Biological monitoring for susceptibility markers is a highly controversial area. Markers of susceptibility may relate to induced variations in absorption, metabolism, and response to environmental agents. For example, measurement of airway reactivity to inhaled broncho-constrictors can be used as a marker of susceptibility to asthma.

Examples of some biological markers of exposure are shown in Table 7.6. Recently there has been much interest in the application of markers in a rapidly developing field sometimes called molecular epidemiology. There has been particular enthusiasm in the study of DNA and protein adducts. However, chemical methods to detect and quantify adducts often rely on costly methods which require highly sophisticated and expensive instrumentation (such as gas chromatography and mass spectrometry) operated by highly skilled technologists. Furthermore, most of these methods still have to be validated and can not be considered and applied as routine measurements.

Table 7.6: Examples of Useful Markers of Exposure

Substance	Biological Marker
Carbon Monoxide	COHb in blood
Lead	Pb in blood
Pentachlorophenol (PCP)	PCP in urine
Alcoholic Beverages	Ethanol in exhaled breath
Volatile Organics (VOCs)	VOCs in exhaled breath

7.7.4. The Indirect Approaches to Estimation of Exposure

Exposure assessment surveys, whether they be questionnaires, telephone interviews or measurements, usually attempt to obtain information in four areas: demographic profile, health status, environmental factors and time-activity. There are three general approaches for obtaining time-activity information. One is called the *estimation* approach, in which an estimate is made of the amount of time spent by study participants in various activities during the time period of interest. The second approach uses *time activity diaries* in which participants are asked to describe all of the activities in which they were engaged during the study period. The third approach is the *observational* approach in which the participants are monitored by outside observers. While this adds a degree of

completeness and accuracy to the data, many people may refuse to participate in a study in which their activities are being monitored. Using data on concentrations in various environments and human activity data as input variables, **calculation models** can predict exposures at individual or population level.

In order to estimate exposures via different exposure routes, **standard values** for the amount of inhaled air and ingestion of drinking-water and soil can be used. One set of such standard values are presented in Table 7.7. for various age groups.

Table 7.7: Recommended standard Values for Daily Intake of Air, Water and soil

Age (years)	Air Inhalation (m ³ /day) ¹	Water Ingestion ² (L/day)	Soil Ingestion (mg/day)	Total Soil Adhered (mg/day)
0-<0.5	2	F:0/0 NBF:0.2/0.8	35	2200
0.5-<5	5	0.2/0.8	50	3500
5-<12	12	0.3/0.9	35	5800
12-	21	0.5/1.3	20	9100
<20	23	0.4/1.5	20	8700
20+				

Source: Health and Welfare Canada. Canadian Environmental Protection Act: First Edition. Environmental Health Directorate, 1992

1. 1000 liters = 1 m³
2. The first value represents straight tap water only, while the second includes tap water-based beverages such as tea, coffee and reconstituted soft drinks. Exclusively breast-fed infants (BF) do not require additional liquids. Estimates for non-breast-fed infants (NBF) are based on volume consumed as drinking-water, and on drinking of 750ml/day of formula made from powdered formula and tap water for total drinking-water.

7.7.5. Estimating Inhalation Exposure

With respect to air measurements, outdoor measurements have been an integral part of environmental monitoring in many countries for several decades. However, indoor air has been ignored until recently. Thus, while many air pollutants are at higher concentrations indoors than outside, indoor air quality monitoring procedures are less well-developed. This will be discussed further in subsequent chapters. In order to estimate an inhalation dose, an estimate of the amount of air a person breathes in a day is required. (Standard values for the amount of air inhaled by various age groups are presented in Table 7.7.)

A person's sex, age, and the amount of physical activity are major factors affecting the volume of air breathed. Other factors influencing the volume of air breathed include:

temperature, altitude, background air pollution, and a person's weight, height, whether he or she smokes, and whether the person has suffered from heart disease. To calculate the inhalation dose, it is assumed that 100% of the contaminant is absorbed after contact. This always results in an overestimation of the internal dose. Table. 7.8.

Table 7.8: Calculating Intake through Inhalation

This can be estimated with the equation:

$$EDI = (C \times IR \times EF) / BW$$

Where: EDI = estimated dose through air inhalation: The air inhalation dose is expressed as milligrams of the contaminant inhaled per kg of body weight per day (mg/kg/day).

C = Concentration of the contaminant in the air, in milligrams per cubic meter of air (mg/m³).

IR = Inhalation rate: The amount of air a person breathes in a day, in cubic meters m³/day). Standard values are given in Table 3.10. If contaminated air is breathed for only part of a day, then inhalation rate is adjusted accordingly.

EF = Exposure factor: Indicates how often the individual has been exposed to the contaminant over a lifetime (unit less). See other texts for discussion of exposure factors.)

BW = Body weight: The average body weight in kilograms (kg) based on an individual's age group. Standard values are given in various publications.

Box 3.6 utilizes the above information in a concrete example.

BOX 3.6

Estimating Lead Intake Via Inhalation by a Child

Task: estimate the cumulative dose of inhaled lead for an 11-year-old child who has been exposed for two hours per day every day since birth, to lead in outdoor air at a concentration of 8×10^{-5} mg/m³. Exposure ended at age 12 when the family moved to another area.

The cumulative dose is calculated as follows:

The inhalation rate (IR) of contaminated air is a fraction of the total air breathed, in this case 2 hours of exposure /day x total daily amount of air inhaled. The total daily amount of air inhaled changes as a child grows (see Table 3.11). Multiplying each of these values by 2/24 (0.083) gives an IR of 0.166m³/day, 0.415 m³/day, and 0.996m³/day for each of the three age periods.

The exposure factors for these periods are calculated as follows:

Age (yrs)	Exposure Factor
0-<.05	183 days of exposure in first six months/4380 days in lifetime (12 years)=0.042
0.5-<5	1642 days of exposure in second period/4380 days in lifetime (12 years)=0.375
5-<12	2555 days of exposure in second period/4380 days in lifetime (12 years)=0.583

<u>Age</u> <u>(yrs)</u>	<u>Concentration</u>	<u>IR</u>	<u>EF</u>	<u>BW</u>	<u>Daily Inhalation Dose</u> <u>(mg/kg/day)</u>
0-<.05	8×10^{-3}	0.166	0.042	7	7.97×10^{-5}
0.5-<5	8×10^{-3}	0.415	0.375	13	9.58×10^{-5}
5-<12	8×10^{-3}	0.996	0.583	27	17.21×10^{-5}
					3.58×10^{-4}

daily inhalation dose of lead is thus estimated to be 3.58×10^{-4} µg/kg/day.

Modified from ATSDR, 1992

A very similar equation to that in Table 7.8 can be applied to the other routes of exposure. The units, of course, will change, as will change, as will the terminology. For example, with respect to ingestion, the inhalation rate becomes the consumption rate. The total dose will be the sum of all the individual doses due to the separate routes of exposure.

7.7.6. Principles of Population Sampling

To assist with the selection of a population sample for human exposure assessment, the following guidance is provided.

A sampling frame must either: (a) list all the people in the target population; or (b) list areas and the approximate number of people linked to each area. If the people in the target population are mobile, they may have to be linked to the areas where they eat or sleep. Developed countries usually have a central statistical bureau that maintains registries or conducts population census, which may form an ideal frame for sampling from the general population. As these listings are rarely complete, sampling frames often need to be conducted in stages, as discussed below, with these data constituting a sampling frame often need to be conducted in stages, as discussed below, with these data constituting a sampling frame for the initial stages of a multi-stage sample. In developing countries, where census data are not generally available, special efforts may be needed to

estimate the population linked to the areas in order to construct a sampling frame.

If the target population consists only of people with specific characteristics, lists of these people may be available. For example, if the target population consists of lactating mothers, clinics in the area may be able to provide lists of mothers who have recently had deliveries. If available lists do not provide nearly complete coverage of the target population, samples from the lists must be supplemented with samples from other, possibly less efficient, frames that provide more complete coverage of the target population (see UNEP/WHO, 1993).

7.7.7. Principles of Environmental Sampling

The potential for errors in environmental exposure assessment is large. Errors may occur with respect to the representativeness of sampling sites, the method of sample collection, the analytic procedure, and data handling.

The representative error refers to whether the sample collected represents the average concentration in the media under study. For example, an outdoor monitor on the roof of a multistoried building may not yield the concentration data needed to estimate average community air exposure. Even if sampling is conducted at a reasonable site, there is always a question as to how representative it is of exposure to residents at different times or when wind blows from different

directions. Portable sampling in various directions and at variable distances from a fixed site can often give guidance on this matter.

Sample collection errors (e.g. for water, soil, or food samples), can usually be minimized simply by using containers which are free of the contaminant of interest. Air samples are more difficult to properly collect and there is considerably more controversy as to the appropriate instrument to use in various situations. Industrial hygienists therefore obtain considerable training in techniques of proper sample collection, and only people trained in these techniques should conduct air sampling.

Analytical errors may arise from the use of improper calibration procedures, variations in temperatures or line voltage in the laboratory, operator mistakes, as well as the intrinsic imprecision and inaccuracy of the analytical method chosen.

Finally, errors in data manipulation may occur at a number of stages, and often relate to the number of individuals involved in obtaining an environmental measurement. These specialists include the field person who collects the sample, the laboratory technician who does the analysis, the computer programmer who enters the data, and the epidemiologist who, often with the help of the statistician, interprets the data.

Quality assurance programs have therefore been developed and much international guidance has been provided on this subject. Procedures include the use of standard reference materials when calibrating instruments, keeping the line voltage and temperature constant, conducting duplicate analyses of some of the collected samples, etc. Sometimes the above activities are considered quality control operational activities. Quality assurance refers to activities that are conducted after the data have been collected, to determine the precision and accuracy of the data, and to sort out improper data. This uses methods such as interlaboratory comparisons, using different analytical methods to analyze the same sample, the use of various statistical procedures to highlight bad data or extreme values, etc. the overall term quality assurance generally includes both quality assurance and quality control activities.

7.7.8. Ensuring Adequate Sample Size

Determining an appropriate sample size requires balancing precision and cost constraints. Guidelines for calculating sample sizes needed for accurate estimates are available in many textbooks and other WHO publications including UNEP/WHO 1993. Even if the final sample sizes are determined primarily by cost constraints, rather than for desired precision, it is essential to calculate the precision that is expected for important parameter estimates and the power

expected for important hypothesis tests. There must, however, be minimum standards for reliability of inferences. In general, a sample size of 50 is the minimum acceptable for human exposure monitoring studies, with a range of 250 or more people considered desirable. In preparing reports based on sampling with borderline or minimal sample sizes, it is essential for the problems regarding inferences to the target population to be discussed. These include: (a) Unreliable point estimates, (b) Unreliable estimates of precision, and (c) lack of normality for interval estimates and hypothesis tests (see UNEP/WHO 1993 for greater detail).

7.8. Health risk characterization

7.8.1. General Approach Summarized

Risk characterization synthesized the first three components of the risk assessment process: hazard identification, dose-response assessment and exposure assessment, and estimates the incidence and severity of potential adverse effects. The major assumptions, scientific judgments and uncertainties should be identified to fully understand the validity of the estimated risk.

Risk characterization (or risk estimation as it is also known) may be subdivided into four different steps as indicated in Table 7.9.

**Table 7.9: Consecutive steps in Health Risk
Characterization**

- Exposure = pollutant concentration/ exposure duration (or it is directly measured by integrated sampling).
- Dose = Exposure (1) x dosimetry factors (absorption rate, inhalation rate, etc.) body weight or surface area.
- Lifetime individual risk = Dose (2) x risk characterization factor (carcinogenic potency, noncarcinogenic threshold [e.g. NOEL] or severity [e.g. NOAEL], with
- Risk to exposed population = Individual risk (3) x number in exposed population (this should take into consideration age, and other susceptibility factors, population activities, etc.).

7.9. Health in environmental impact assessment (EIA)

A part from health risk assessment in field situations it is also important to consider potential health effects of projects or activities which are planned for the future. However, health effects have often received inadequate attention during the formulation of development policies and planning of projects. In many countries where procedures exist to assess

environmental impacts, only (or predominantly) impacts on the biophysical environment are assessed. When these parameters conform to the legally established environmental standards it is assumed that human health effects are not likely to occur.

In principle the assessment of adverse health impacts follows an approach similar to the risk assessment framework discussed in the previous sections of this chapter. First, potential hazards associated with the project which require further investigation have to be identified. Subsequently, emissions have to be calculated or estimated using technological specifications of the project. Based on these data, emission concentrations, exposure and total dose should be calculated using mathematical models which have been developed specifically for these purposes.

As an environmental impact assessment (EIA) is a practical process, it is not generally possible to undertake additional primary research simultaneously. Consequently, conclusions must usually be based on currently accepted scientific knowledge. Furthermore, no actual measurements can be performed during the preparation stage of a project, other than baseline assessments or measurements from pilot projects. Therefore, extrapolation of data regarding emissions, exposures and (if available) health effects from similar projects can be extremely useful. These extrapolations from

one situation to another with different geographical and demographic features, as well as exposure characteristics, usually require a number of assumptions, and therefore again specific expertise is also required.

The health component of environmental impact assessments should incorporate more than the best scientific information available. It should draw upon community-based information and traditional knowledge of native peoples and others in the community. And it should recognize that many projects have beneficial as well as adverse effects on health and well being. By creating jobs and providing other economic benefits that contribute to a better standard of living, health may be greatly improved because of the project in question. As noted in chapter 1, economic well-being has been repeatedly linked with longevity and other indicators of health, because, among other reasons, people with adequate income can afford to eat balanced diets and live healthy lifestyles. Adverse effects on health may be disproportionately experienced by people who do not share in a project's benefits. Thus the health components of the EIA should assess who will benefit and who may experience adverse effects. If potential adverse effects are identified, recommendations for mitigation and follow-up measures should be included in the environmental impact statement (EIS) which the project's proponent is required to do. EIAs may also consider alternatives to the project, including the potential effects on health of not allowing

the project to proceed. Although there may be jurisdictional considerations regarding which government department is responsible for occupational versus public health in some countries, both components are essential to ascertain the potential benefits and adverse effects of a proposal.

7.10. Exercise questions

1. List and describe Environmental factors of human exposures?
2. What are the advantages and disadvantages of environmental and biological Monitoring respectively?
3. Describe the concept of EIA?

CHAPTER EIGHT

SAMPLING AND ANALYSIS

8.1. Learning Objective

After the completion of this chapter, the student will be able to:

1. Describe the importance of Air as the basic health requirement of human life
2. Define what air pollution means and other related terms
3. Enumerate different types of air pollutants
4. List physical forms of pollutants

8.2. Introduction

Some air pollution problems, such as foul odors, are relatively straightforward to manage and can be dealt with as a public nuisance. Industrial and urban air pollution is more complicated, and effective control requires (a) identifying and measuring the pollutants that are most responsible for the problem, and (b) reducing or preventing their emission at the source.

Control of air pollution requires the identification and control of individual sources of emissions to air in order to prevent the accumulation of air pollution in a certain region, or air shed.

An air shed is a space, such as a valley, basin, or plain, within which air mixes relatively freely but beyond which movement is relatively slower, and typically depends on winds. In order to improve air quality within an air shed it is necessary to control all the sources within the air shed.

In order to set targets for the control of air pollution, it is necessary to set standards or guidelines. The word standard implies a set of laws or regulations that limit allowable emissions or that do not permit degradation (deterioration) of air quality beyond a certain limit. The word guideline implies a set of recommended levels against which to compare air quality from one region to another over time.

8.3. Ambient Air Quality Standards and Guidelines

Ambient air quality standards or guidelines are levels of general air quality in the region that the jurisdiction responsible cannot allow to be exceeded. Sometimes the penalty for this is withholding of funds from the national government or some administrative penalty. Ambient air quality is monitored in various places within the region and when the level of a particular pollutant is exceeded, this is called an exceedance. The number of exceedances, the average levels of air pollution, and the peak levels during one hour may all be used as indicators in air quality standards or

guidelines. Ambient air quality standards may include a non-degradation policy. This means that not only should air pollution not exceed certain levels, but it cannot be permitted, on average, to get worse over time even within the allowable levels.

Table 8.1: Relative Contribution of Different Emissions and Respective Pollutants in Sao Paulo, Brazil

	Particulate Matter	Sulfur Oxides	Carbon Monoxide	Nitrogen Oxides
Vehicles	40%	64%	94%	92 %
Industry	10%	36%	3%	7%
Other	50%	0%	3%	1%

Source: Stephens et al., 1995

The level of government that sets the standards or guidelines is not necessarily the level of government that enforces them. The United States, for example, has standards that are set by an agency of the Federal Government, the US Environmental Protection Agency (EPA). (See Table 10.) The EPA has divided outdoor air pollutants into two categories: criteria pollutants and hazardous pollutants which are mostly carcinogens such as asbestos. Standards for hazardous chemicals usually take the form of maximal concentrations to provide a margin of safety. They can be enforced as laws but

this is usually done at the state level. Some states have set stricter environmental standards. Canada, on the other hand, has guidelines that are recommended by a federal department, Health Canada, but any action to be taken is the responsibility of the provinces, which may set local standards. On paper, Canada's guidelines are much stricter, but they must be understood to be targets, not rules. Because air quality in Canada is not generally as polluted (with some local exceptions), the use of guidelines allows greater flexibility to local authorities to deal with the problem. If the pollution problem were more severe, the adoption of national air quality standards could permit tighter legal enforcement and stricter regulation across the country. Table 11 presents the revised Air Quality Guidelines for Europe recommended by the WHO.

Table 8.2: Air Quality Standards, United States, 1989

Pollutant	Primary Standards	Average Time	Health Effects
Ozone	0.12 ppm (235 $\mu\text{g}/\text{m}^3$)	1hr	Decrements in lung function, possibly Chronic lung disease
PM ₁₀	50 $\mu\text{g}/\text{m}^3$ 150 $\mu\text{g}/\text{m}^3$	Annual (arithmetic Mean); 24hr	Chronic respiratory disease, altered lung function in children
SO ₂	0.03 ppm(80 $\mu\text{g}/\text{m}^3$) 0.14 ppm (365 $\mu\text{g}/\text{m}^3$)	Annual (arithmetic Mean); 24 hr	Exacerbation of asthma
NO ₂	0.053 ppm(100 $\mu\text{g}/\text{m}^3$)	Annual (arithmetic Mean)	Increased respiratory infections, acute lung disease
Carbon	9 ppm (10mg/m ³)	8 hr	Aggravation of coronary artery disease
Monoxide	35 ppm (40 mg/m ³)	1 hr	
Lead	1.5 $\mu\text{g}/\text{m}^3$	Quarterly average	Development effects on children

Standards may take two forms: ambient air quality standards and emission standards. Ambient air quality is the general quality of air outdoors in the region. Guidelines are usually for ambient air quality only. Emissions standards set the amount of pollution that is allowed to come from a particular source.

**Table 8.3: WHO Air Quality Guidelines for Europe,
Revised 1994**

Compound	Guideline	Value	Averaging Time
Ozone	120µg/m ³	(0.06 ppm)	8 hr
Nitrogen dioxide	200µg/m ³	(0.11 ppm)	1 hr
	40 to 50µg/m ³	(0.021 to 0.026 ppm)	Annual
Sulfur dioxide	500 µg/m ³	(0.175 ppm)	10 min
	125µg/m ³	(0.044 ppm)	24 hr
	50µg/m ³	(0.017 ppm)	Annual
Particulate Matter		_____ a	_____
Carbon monoxide	100µg/m ³	(90 ppm) ^b	15 min
	60 µg/m ³	(50 ppm)	30 min
	30 µg/m ³	(25 ppm)	1 hr
	10 µg/m ³	(10 ppm)	8 hr

a. No guideline values were set for particulate matter because there is no evident threshold for effects on morbidity and mortality.

b. The guideline is to prevent carboxyhaemoglobin levels in the blood from exceeding 2.5%. The values above are mathematical estimates of CO concentrations and averaging times at which these concentrations should be achieved.

Ambient air quality standards are set on the basis of known adverse effects that occur when pollution levels reach the level of the standard. Some standards are set on the basis of damage to vegetation and materials, others on the basis of

health effects or visibility. In recent years, standards have been increasingly set on the basis of human health effects, after an exhaustive review of scientific studies. In order to protect the health of the public, air quality standards today are often set by conducting a risk assessment that predicts what the expected number of cases of cancer or of death might be at a given level of air pollution. When the risk appears to be negligible, the standard is set as close to that level as is feasible. These are called risk-based standards. However, they depend on studies that provide a reasonable guide to risk at low levels of exposure. The studies that support these standards have often been criticized because they do not necessarily protect the most susceptible members of the population. Recent studies have suggested that the standards for small particulates (PM_{10}) that had been adopted in most developed countries, and which were thought to be safe, may still be associated with increased death rates from a variety of diseases. This is why the WHO guidelines for Europe do not specify a level for particulates.

8.4. Exercise questions

1. Explain the importance of having guidelines and standards.
2. Describe what guideline means.
3. Describe what standards means.
4. Explain the difference between guidelines and standards.

CHAPTER NINE

AIR POLLUTION PREVENTION AND CONTROL

9.1. Learning Objective

After the completion of this chapter, the student will be able to:

1. Define what air pollution prevention and control means
2. Describe the importance of Air as the basic health requirement of human life
3. Enumerate different types of air pollution prevention methods

9.2. Introduction to the course

The reduction of energy consumption, use of non-conventional sources for energy and natural source of energy and maintenance green belts is the key to manage air pollution problems. The measures for prevention and control of air pollution are given below:-

- Increasing the community awareness about air pollution, sources and effects of pollution and how to avoid them.

- Substitution measures- The current industrial or combusting practices which produce pollutants are replaced by non-hazardous or less hazardous process. Substitute electric power in place of fossil fuels, coal substituted by the biogas plants. Use of solar energy and hydraulic operations for industrial purposes should be encouraged. The use of solar energy and hydraulic operations for industrial purposes should be encouraged. The use of smokeless churlish in place of age old churlish dramatically improves indoor air quality.
- Containment action: Escape of pollutants in the air from the industrial operations can be controlled by operating local exhaust ventilation, trapping and then the disposal of pollutants.
- Dilution: Maintenance of green belt between and around the industries, in between industries and civilian habitat filter a lot of air pollutants and maintains air quality.
- Legislative action: The factories act and smoke Nuisance Act lay down measures for height of chimney stacks, use of arrestors, for industrial areas. The lead levels in petrol can be minimized or leadless petrol can be made available through governmental regulatory approach.

- Active community involvement: Regular maintenance of automobile vehicles; use of arrestors to the exhaust from automobiles; complete combustion of coke, coal and wood; screening of windows; use of LPG gas; proper effective ventilation in home and at work place, use of solar and biogas energy, community action for collection and final disposal of refuse and solid wastes, maintenance of green belts, forbidding tobacco smoking, use of smokeless churlish, maintenance public places; cleanliness of streets and open areas and a lot many actions can be undertaken for control and prevention of air pollution.

9.3 Control of Ambient Air Pollution

Control of emissions at each source is the key to managing air quality, but transportation policy, energy policy (such as the choice of fuels), and siting/ zoning of facilities that may emit pollution all play a critical role. A major element in the success of air pollution control is the degree of authority that can be exerted by the government agency that has this responsibility. The ability to close or shut down a plant is the ultimate tool for enforcement agencies, but the ability to fine, bring lawsuits, and to prosecute offenders is just as important. Often just the threat of such action motivates the management of a plant to cooperate and to correct the problem.

Emissions standards (rules about how much pollution a particular source may emit to the atmosphere) require periodic inspection and regular monitoring to be effective. These are generally easier to enforce for stationary sources, where equipment can be set up on a permanent basis and the pollution control apparatus can be inspected directly. The source or facility may require a permit from the government to operate or may be required to register and to provide regular reports on the pollution it has generated.

Generally, emissions standards for individual factories, power plants, or other stationary sources are allocated an allowable level of emissions based on their past performance and share of contribution to the regional air shed. They must not exceed this allowable level of emissions or they will receive a citation and must pay a fine. (In practice, the fine must be high enough to deter violations and not to be just another cost of doing business.) If they are repeat violators, their permit to operate can be suspended if the law allows.

In some jurisdictions, the entire plant is considered a single source; if engineers can reduce emissions in one part of the plant, they are allowed to build new facilities that increase emissions in another part or to build a new addition to the plant that may generate new emissions. The overall level of emissions from the entire plant must not increase, however. This is called the Bubble concept, because the plant is

thought of as being enclosed in a bubble and the air and the air quality in the bubble cannot be allowed to deteriorate.

Mobile sources are difficult to monitor, however, many jurisdictions require regular vehicle inspections to ensure that emissions from each truck or automobile are within acceptable limits (see Mage and Zali, 1992.) Box 3 summarizes some strategies to address motor vehicle air pollution.

Dust control methods

1. Local Exhaust

Local exhaust is frequently used at point of high dust production; when it can be combined with a hooded enclosure such as ventilation can be quite effective. Exhausting the air without dust removal can create dust load in the outside area that may contaminate the plant or dilution ventilation may be the best solution.

2. General ventilation with dilution

In instances in which the sources of dust generation are numerous, widely distributed general or dilution ventilation may be the best.

3. Recirculation of air

Recirculation of clean air from a dust collector for the purpose of conserving energy requires careful consideration because even a well maintained fabric

filter dust collect or operating under ideal conditions can not remove all dusts particles to satisfy the PEL (less than one percent quartz/ 10 mg./cubic meter nuisance dust.

4. Respirable usage

Since most dusts are hazardous to the lungs, respirators are a common method of primary or secondary protection. Respirators are appropriate as a primary control during intermittent maintenance or cleaning activities when fixed engineering controls may not be feasible. Respirators can also be used as supplement to good engineering and work practice control for dusts to increase employee protection and comfort.

To be effective respirators must be matched to the type of particulate hazard present. The critical exposure factors mentioned above (type of dust, length of exposure, dust size, concentration etc.) determine the degree of hazard and the type of respirators that should be employed.

Box 3

Motor vehicle Air Pollution: Health Effects and Control Strategies

Studies of human exposures to air pollution from motor vehicles have revealed the following:

- Concentrations of some air pollutants inside motor vehicles and along roadsides are typically higher than those recorded simultaneously at fixed-side monitors.
- Exposures tend to be higher inside automobiles than in buses and other vehicles used in public transit.
- Priority lanes used to afford speed advantages to buses and car pools tend to reduce air pollutant exposures.
- Concentrations of air pollutants in enclosed settings are similar to outdoor concentrations in the absence of indoor sources, but tend to lag behind the peak concentrations observed outdoors. (A notable exception is commercial buildings attached to inadequately ventilated parking garages.)
- Concentrations of motor vehicle air pollutants decline with greater distance from the road, suggesting that passengers and vehicles are at greatest risk, followed by pedestrians and street merchants along roadsides, and then the general urban population.

Motor vehicle emissions may be reduced by: 1) controlling vehicle performance, and 2) altering fuel composition. With respect to vehicle performance, this can be controlled by ensuring that vehicles are designed and

built to meet standards. It is also necessary that they be properly maintained. Proper maintenance, in turn, can be promoted by providing incentives to car owners to obtain proper maintenance and by marketplace incentives. Requiring maintenance through a mandatory inspection and maintenance programme is considered by many to be the most effective incentive for car owners.

Fuel composition may be controlled as a direct means of controlling emissions, e.g. reducing the lead content in leaded gasoline or reducing sulfur content to control sulfate emissions. Studies suggest that gasoline hydrocarbon emissions decrease significantly with lower fuel sulfur. Control of gasoline volatility is another strategy for reducing vehicle evaporative and refueling emissions, especially in areas with warmer climates. Some additives have been effective in lowering hydrocarbon emissions and carbon monoxide.

Reduction of emissions per vehicle mile traveled can be very effective in controlling emissions. Strategies in this area include car pooling, increased use of mass transit, parking restrictions, gas rationing, etc. Policies would therefore be needed to: create more efficient public transportation systems; increase the load factor of existing vehicles; shift time of peak traffic (e.g. staggering work hours); improve circulation using synchronized signals, reduce travel demand, e.g. by redistribution of urban activities.

Source: Mage and Zali, 1992

In order to effectively manage air quality in an urban region, an administrative mechanism must be set up that includes trained inspectors and technical staff who can operate the

complicated equipment needed for air quality monitoring and who can interpret the results. A permitting or registration system is needed for enforcing emissions standards. Public education should be very much a part of the duties of the staff, as should enforcement and monitoring. Many air quality agencies are operated separately from public health agencies, often attached to the environmental departments of government. Ideally, these agencies have the authority to meet with plant owners or managers before facilities are even built in order to avoid problems before they occur.

Due to growing public concern, many nations initiated air quality monitoring in the 1960s. In 1973, the WHO set up a global programme to assist countries in operational air pollution monitoring; this project became a part of UNEP's Global Environmental Monitoring System in 1976. This project covers some 50 countries, and data from this project suggest that nearly 900 million people living in urban areas around the world are exposed to unhealthy levels of sulfur dioxide and more than one billion people are exposed to excessive levels of particulate matter.

Some of the general measures of controlling indoor air pollution are:

- ❖ Stove design improvement (to increase the efficiency of complete combustion)
- ❖ Use of cleaner fuel

- ❖ Improving house design and construction of proper ventilation
- ❖ Health Education
- ❖ Improving standard of living

Ventilation: this might be through opening windows, doors, or using fans with or without washing or aid, so that there is a considerable air interchange. It is believed that with in practical limits of air interchange, there is not apparent effect up on disease incidence. Practically this method can not be sued in hospitals or nurseries, unites and otherwise the incoming air is flattered and conditioned

9.4. Exercise question

Study Exercise

Air quality management may involve controlling sources of emissions from industry, transportation, and homes. What effect on air quality may be expected from national transportation policies that favor automotive transportation over mass transit? What may be expected from a national energy policy that favors the burning of fossil fuels over hydroelectric or nuclear energy? Does the economic base and structure of the community have any implications for air quality in the region? What role does city and regional planning play in influencing air quality? In the region? What role does city and regional planning play in influencing air quality? Use your home community as an example of these issues, and then compare the situation in another city, town, or village in your country. A number of initiatives and suggestions for better management of air resources have been discussed in this chapter. Try to develop other initiatives that could be used to promote air quality conservation. These could be economic, social, legal or physical in nature.

REFERENCES

1. World Health Organization. Air Pollution. WHO, Geneva, 1961
2. Purdom PW, Editor. Environmental health and edition, San Diego: Academic press, 1980.
3. World Health Organization. Basic Environmental Health, WHO, Oxford University, 2001
4. World Health Organization. Our planet, out health: report of the WHO Commission on Health and Environment. Geneva: WHO. 1992
5. The World Bank Development Report 1992: development and the environment. Oxford: Oxford University Press, 1992.
6. Turk J and Turk A. Environmental sciences. 4th edition, Philadelphia: W.B. Saunders Company, 1992.
7. P. Aarne Vesilind (1984) Environmental pollution & control 2nd ed.
8. J.A Salvato (1992) Environmental Engineering and sanitation 4th.ed.
9. Timmy Katyel. Eatal, Environmental pollution new delhi 1989.



10. John A. Troller. Sanitation in food processing 2nd edition
US Academic press limited 1993 (P415-430)
11. Gilbert "Introduction to Engineering & Science" 2nd edition
1996.
12. Bruce N, Neufeld, Boy E, West C (1998). Quantifying the
effect of indoor biofuel air pollution on respiratory health in
observational studies: the role of confounding factors
among women in highland Guatemala. *Int J Epidem*; 27:
454-458
13. Bruce N (1999). Lowering exposure of children to indoor
air pollution to prevent ARI: the need for information and
action. Capsule Report (3), Environmental Health Project,
Arlington, VA.
14. Kirkwood B., Gove S., Rogers S., Lob-Levyt J., Arthur P,
Campbell H (1995). Potential interventions for the
prevention of childhood pneumonia in developing
countries: a systematic review. *Bulletin of the World
Health Organization*; 73: 793-798
15. McCracken J, Smith K (1997). Annotated Bibliography:
ARI and Indoor air pollution. Environmental Health
Project, Arlington, VA.



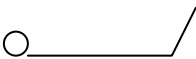

16. Murray C, Lopez A (Eds) (1996). The Global Burden of Disease, Vol 1. Harvard University Press: pp 226-227.
17. Smith K.R (1987). Biofuels, Air pollution and health. Plenum Press, New York 1987.
18. Smith K (1989). Dialectics of improved stoves. Economic and Political Weekly, March 1: pp 517-522.
19. Smith K (1993). Fuel combustion, air pollution exposure, and health: the situation in developing countries. Ann Rev Environ Energy; 18: 526-556.
20. WHO. Health and Environment in Sustainable Development. WHO/EHG/97.8 WHO, Geneva 1997.
21. World Resources Institute, UNEP, UNDP, World Bank (1998). 1998-99 World Resources: a guide to the global environment. Oxford University Press.

APPENDIX

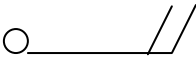
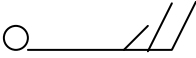
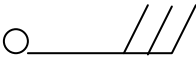
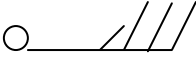
Annex-1

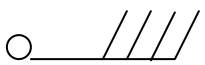
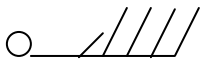
Weather- man wind measuring reports system

Beaufort numbers	Map symbol for wind speed and direction	Speed M.P.H	Description	Specification
0	0		calm	Smoke rises vertically
1		1 to 3	Light air	Wind direction shown by drift of smoke
2		4 to 7	Slight breeze	Wind felt on face; leaves rustle; flag stirs
3		8 to 10	Gentle breeze	Leaves & twigs in constant motion; wind extends light flags
4		13 to 18	Moderate breeze	Dust, loose paper, and small branches are moved, flags flap
5		19 to 24	Fresh breeze	Small trees in leaf begin to sway; flags ripple
6		25 to 31	Strong breeze	Large branches in motion; whistling telegraph wires, flags beat.
7		32 to 38	Moderate Gale	Whole tree in motion; flags are extended.

8		39 to 46	Fresh Gale	Leaves & twigs in constant motion; wind extends light flags
9		47 to 54	Strong gale	Slight damage to house
10		55 to 63	Whole gale	Trees uprooted; much damage to house
11		64 to 75	Storm	Widespread damage
12		Over 75	Hurricanes	Excessive damage

Annex-2

Some questions worth asking about fuel, cooking and ventilation

1. Type of fuel

- Biomass (wood, agriculture waste, grass, leaves, etc manure, dried dung)
- Biogas
- Wood Alco hole
- Fossil fuel (coal, coke, oil, kerosene, natural gas, propane)

2. Type of stove

- Stone tripod (hole in the ground, clay and metal)

3. Location

- Inside one room hut (special indoor cooking and outdoor)

4. Uses

- Cooking only (cooking and heating)

5. Ventilation

- None (windows, hole in roof and chimney)

6. Fuel gathering

- Women (women and children, men)

1. **Hours/day fuel gathering?**
2. **Hours/day at stove?**
3. **Who cooks, who tend fire?**
4. **Visible evidence of indoor air pollution?**
5. **Respiratory symptoms?**
6. **Person in household, person directly exposed?**

Annes-3

INDOOR AIR SAMPLING PROCEDURE

I. Gravimetric sampling technique

- Total suspended particulate matter will be measured by air suction foot pump.
- Measurement is taken at a height ≥ 1 meter roughly at breathing zone.
- A distance of 1m from outside perimeter
- Filters will be placed in a constant temperature (25°C) for 24 hrs prior to both on and off weights
- The difference of the first weighing and the second weighing will be the weight of particulate matter.
- Filters will be placed in sealed container during transport.
- Analysis will be done gravimetrically using a micro balance (0.00001 precision)
- To determine P.M₁₀ according to EPE (1982)
P.M₁₀ = 0.55xP.M will be used.

II. Settle plate sampling technique

- Pour a sterile medium into sterile plate and avoid surface moisture, Mark them with distinctive numbers and prepare a recorded of the position, time and duration for the exposure of each.

- Uncover the plate in its chosen position for the measured period of time, and then at once replace its lid. It is generally suitable to expose plates on tables with legs about 1m above the ground.
- Incubate the plates aerobically for 24 to 49 hrs at 37°C.
- Count the colonies, preferably with the use of colony counter (plate microscope) to detect the smallest ones.
- Express the results as the number of bacteria carrying particles setting on a given area in a given period of time.

Annex-4

Composition of clean, dry atmospheric air

Component	Concentration (ppm)	Estimated residence time
Nitrogen	78.1×10^4	Continuous
Oxygen	21×10^4	Continuous
Argon	93×10^2	Continuous
Carbon dioxide	3.2×10^2	2-4 years
Neon	18	Continuous
Helium	5.2	Up to 2 million years
Krypton	1	Continuous
Xenon	8×10^{-2}	Continuous
CO	0.1	0.5 years
Methane	1.2	4-7 years
N ₂ O	25×10^{-2}	4 years
NO	6×10^{-4}	5 days
NH ₃	6×10^{-3}	7 days
H ₂ S	2×10^{-4}	2 days
SO ₂	3×10^{-4}	4 days
H	0.5	*
O ₃	0.02	Up to 60 days

*little is known about residence time