

LECTURE NOTES

For Health Science Students

Medical Biochemistry



Solomon Adugna, Lakshmi Ahuja Mekonnen Alemu, Tsehayneh
Kelemu, Henok Tekola, Belayhun Kibret, Solomon Genet
Gondar University, Jimma University, Debu University

In collaboration with the Ethiopia Public Health Training Initiative, The Carter Center,
the Ethiopia Ministry of Health, and the Ethiopia Ministry of Education

2004



Funded under USAID Cooperative Agreement No. 663-A-00-00-0358-00.

Produced in collaboration with the Ethiopia Public Health Training Initiative, The Carter Center, the Ethiopia Ministry of Health, and the Ethiopia Ministry of Education.

Important Guidelines for Printing and Photocopying

Limited permission is granted free of charge to print or photocopy all pages of this publication for educational, not-for-profit use by health care workers, students or faculty. All copies must retain all author credits and copyright notices included in the original document. Under no circumstances is it permissible to sell or distribute on a commercial basis, or to claim authorship of, copies of material reproduced from this publication.

©2004 by Solomon Adugna, Lakshmi Ahuja Mekonnen Alemu, Tsehayneh Kelemu, Henok Tekola, Belayhun Kibret, Solomon Genet

All rights reserved. Except as expressly provided above, no part of this publication may be reproduced or transmitted in any form or by any means, electronic or mechanical, including photocopying, recording, or by any information storage and retrieval system, without written permission of the author or authors.

This material is intended for educational use only by practicing health care workers or students and faculty in a health care field.

Table of Contents

Table of Contents.....	i
Acknowledgement.....	v
Introduction	vi
Solomon Adugna and Lakshmi Ahuja	
Unit One: Enzymes	1
<i>Henok Tekola</i>	
Principles and classifications of Enzymes	5
Mechanism action of Enzymes	7
Enzyme Inhibition	13
Regulation of Enzyme activity	18
Enzymes in clinical diagnosis	19
Unit Two: Carbohydrate Metabolism.....	23
<i>Belayhun Kibret</i>	
Chemistry of Carbohydrates	23
Functions of Carbohydrates	31
Digestion and absorption of Carbohydrates	33
Glycolysis	35
Glycogen Metabolism	42
Glycogen storage diseases	45
Pentose phosphate pathway	46
The Cori - cycle	48
Gluconeogenesis	49
Unit Three: Integrative Metabolism Bioenergetics	54
<i>Tsehayneh Kelemu</i>	
Introduction	54
Structural basis of high energy phosphate	55
Formation and utilization of ATP	56
Catabolism of fuel molecules	56
Concept of Free energy	58
Oxidation-reduction reactions	58
Aerobic energy generation	61
Kreb's cycle	63
Function and regulation of kreb's cycle	70

Electron transport system and oxidative Phosphorylation	71
Respiratory control	77
Uncouplers	77
Respiratory poisons	78
 Unit Four: Lipid Metabolism	 80
<i>Solomon Genet</i>	
Classification of Lipids	80
Types of Lipids	80
Digestion and absorption of Lipids	86
Metabolism of Fatty acids and Triacyl Glycerols	88
β -Oxidation of Fatty acids	90
Metabolism of Ketone bodies	93
Biosynthesis of Fatty acids and triacyl glycerols	97
Cholesterol Metabolism	99
Atherosclerosis	101
Hypercholesterolemic drugs	101
Lipid storage diseases	102
Fatty Liver	102
Lipoproteins	102
Chemical compositions of Membranes	104
 Unit Five: Amino acids and Proteins	 105
<i>Solomon Adugna</i>	
Classification of amino acids	106
Properties of amino acids	115
Peptides	119
Glutathione synthesis	121
Proteins	124
Classifications of proteins	124
Levels of organization of proteins	126
Denaturation of proteins	131
Hemoglobin and Myoglobin	135
Sickle cell Hemoglobin	136
Sickle cell disease, Sickle cell trait.....	136
Digestion and absorption of proteins	137
Amino acid catabolism	141
Nitrogen balance, excretion and the urea cycle.....	144

Defects in the urea cycle.....	150
The Glucose - Alanine cycle	151
Inborn errors of amino acid metabolism.....	152
Amino acid derived nitrogenous compounds.....	154
Clinical problems.....	159
 Unit Six: Vitamins and Coenzymes	 161
<i>Solomon Adugna</i>	
Water soluble vitamins.....	161
Chemistry, sources, function and deficiency of:	
Thiamine	161
Riboflavin	163
Niacin	164
Pyridoxine	165
Biotin	166
Cobalamin.....	167
Folic acid.....	169
Pantothenic acid.....	170
Ascorbic acid.....	171
Fat soluble vitamins	172
Chemistry, Sources, function, deficiency and Hypervitaminosis of:	
Vitamin A.....	173
Vitamin D.....	177
Vitamin E.....	179
Vitamin K.....	181
 Unit Seven: Mineral Metabolism	 183
<i>Lakshmi Ahuja</i>	
Mineral	183
Sodium and potassium	183
Calcium and Phosphate.....	184
Trace elements	185
Iron	185
Copper	187
Magnesium.....	188
Flourine	188
Iodine	189
Zinc	189

Selenium	191
Unit Eight: Hormones	193
<i>Lakshmi Ahuja</i>	
Definition and classification	194
Biosynthesis, storage, transport	196
Mechanism of action of steroid hormones	197
Mechanism of action of protein hormones	198
Receptors and diseases	202
Second messengers	203
Insulin synthesis, secretion and metabolic role	205
Diabetes mellitus	209
Symptoms and complications of DM	210
Glucagon	211
Clinical aspects	212
Thyroxin	213
Synthesis and Metabolism	213
Hypo and Hyper Thyroidism	214
Goiter	215
Catecholamines	216
Pheochromocytoma	217
Case Histories	217
Unit Nine: Molecular Genetics	220
<i>Mekonnen Alemu</i>	
Structure of Nucleic acids	220
Types of Nucleic acids	226
Replication of DNA	230
DNA Damage and repair mechanism	231
RNA synthesis	233
Post transcriptional Modifications	236
Translation/Protein synthesis	240
Regulation of protein synthesis	242
The Genetic code	243
Post translational processes	244
Glossary	246
Reference	253

ACKNOWLEDGMENT

The team of authors from the department of Biochemistry of various Universities would like to thank and express their deep rooted gratitude to the Carter Center (EPHTI) for its initiation and drive to prepare this teaching material. The Center has not only supported the team financially, but also stood behind it firmly throughout the entire period of this experience. Thus Carter Center has become the pioneer in the field of preparing teaching material and also in training a team of authors for future endeavors of the kind.

In addition, the task would have been impossible without the directing of the Federal Democratic Republic of Ethiopia, Ministry of Education.

It is also not out of place to thank the administration of Gondar University, Debu University and Jimma University for extending cooperation whenever it was needed.

The authors extend their appreciation to Ato Akililu Mulugeta, Manager, Carter Center, who has shepherded the team's effort through manuscript to finished pages.

The authors are particularly grateful to Abdel-Aziz Fatouh Mohammed (Ph.D) Associate professor of Biochemistry, Medical Faculty, Addis Ababa University and Ato. Daniel Seifu, Lecturer of Medical Biochemistry, Medical Faculty, Addis Ababa University for their highly professional editing and most helpful comments about many aspects of the text.

INTRODUCTION TO BIOCHEMISTRY

Medical biochemistry is an essential component of curriculum for all categories of health professionals. Contemporary Biochemistry plays a crucial role in the Medical field, be it metabolic pathways, storage diseases, mechanism action of varied biomolecules or inter and intra cellular communications.

A lecture note on Medical biochemistry integrates and summarizes the essentials of the core subject. Topics are carefully selected to cover the essential areas of the subject for graduate level of Health sciences. The chapters are organized around the following major themes:

1. Conformation of biomolecules, structure and their relationship to biological activity
2. synthesis and degradation of major metabolites
3. Production and storage of energy
4. Biocatalysts and their application
5. Intercellular communication by hormones
6. Molecular events in gene expression and regulation

Enzymes:

Body proteins perform a large number of functions. One such unique function is, they act as biological catalysts (Enzymes). They are responsible for highly complex reactions. They direct the metabolic events and exhibit specificity toward substrates, regulate the entire metabolism. Thus, they play key role in the degradation and synthesis of nutrients, biomolecules etc. The most important diagnostic procedures involves assay of enzymes. They assist to know damaged tissues, the extent of tissue damage, helps to monitor the course of the disease and used as a therapeutic means of diagnosing a vast array of diseases.

Amino acids and Proteins

Living systems are made up of Proteins. They are the dehydration polymers of amino acids. Each amino acid residue is joined by a peptide linkage to form proteins. Proteins are the molecular instruments in which genetic information is expressed, Hormones, Antibodies, transporters, the lens protein, the architectural framework of our tissues and a myriad of substances having distinct biological activities are derived. The type, nature and number of amino acids impart characteristic properties to the proteins.

There are about 300 amino acids, but only 20 are coded by DNA of higher organisms. Acid base properties of amino acids are important to the individual physical and chemical nature of

the protein. The structural organization of proteins could be primary, secondary, tertiary and quaternary. The three dimensional structure is the most biologically active one.

The unfolding and disorganization of the proteins results in denaturation, the process is mostly irreversible. Such a protein may lose its biological function. Many amino acid derived peptides are of biological importance and special products formed from them are of critical importance to the body.

Carbohydrates

They are biomolecules, found abundantly in living organisms. They contain more than one hydroxyl group (polyhydric) In addition to aldehyde or ketone group. Thus, they form in to polyhydroxy aldoses or polyhydroxy ketoses. Carbohydrates can be classified in to Monosaccharide, disaccharide, and polysaccharides. Mono is the smallest sugar unit, disaccharide is made up of two monosaccharides joined by glycosidic linkages .The linkage can be α or β . A polymer with more than 10 monosaccharide units is called polysaccharide.

Carbohydrates have a wide range of functions. They provide energy; act as storage molecules of energy. Serve as cell membrane components and mediate some forms of communication between cells.

Absence of a single enzyme like lactase causes discomfort and diarrhea. The failure of Galactose and fructose metabolism due to deficient enzymes leads to turbidity of lens proteins (Cataract). Blood glucose is controlled by different hormones and metabolic processes. People suffer from Diabetes if the insulin hormone is less or not functioning well, such people are prone to atherosclerosis, vascular diseases, and renal failure.

Integrative Metabolism and Bioenergetics

Oxygen is utilized for the conversion of glucose to pyruvate. The same metabolite also forms from amino acid and protein metabolism. Other precursors like Glycerol, propionate can give rise to pyruvate. The main breakdown product of pyruvate is acetyl CoA, which is the common intermediate in the energy metabolism of carbohydrates, lipid and amino acids. It enters central metabolic pathway, the Citric acid cycle in the mitochondrial matrix. Here it is converted to CO_2 , H_2O and reduced coenzymes (NADH, FADH_2). These reduced nucleotides are the substrates for oxidative Phosphorylation in mitochondria, their oxidation provide the energy for the synthesis of ATP, the free energy currency of cells.

Lipids

The bulk of the living matter is made up of Lipids, carbohydrates and proteins.

Lipids are water insoluble, but can be extracted with non-polar solvents like Benzene, methanol, or ether.

Some lipids act as storage molecules for example triglycerides stored in adipose tissue. Transport forms of lipids (Lipoproteins), are present in combination with proteins

Building blocks of lipids are fatty acids. Some lipids like cholesterol lack fatty acids but are potentially related to them. Lipids are constituents of cell membrane and act as hydrophobic barrier that permits the entry/exit of certain molecules. Lipids carry fat soluble vitamins and form special biomolecules. Lipid imbalance can lead to serious diseases like obesity and atherosclerosis. Break down of fatty acid produce energy, excessive breakdown cause ketosis, ketoacidosis, coma and death.

Cholesterol level in blood is controlled by several regulatory mechanisms. Such information is applied in the treatment of patients with high cholesterol levels.

Vitamins and Minerals

They are organic compounds required in small quantities for the functioning of the body. They are not synthesized in the body, needed to be provided in the diet. Vitamins do not generate energy. Generally they are responsible for the maintenance of health and prevention of chronic diseases. Grossly there are two groups' Water soluble vitamins are Vit. B-complex and C. Fat soluble vitamins are Vit A, D, E, and K.

Minerals are elements present in human body .Elements like C,H,N are provided by the diet and water .Second group includes Ca, P, Mg, Na, K. Cl and Sulphur. These are required in large quantities (100mg or more/day). They are called Macro elements.

A third group includes trace elements, which are required in small amounts for example Fe, I, Zn, etc.

Fluorine deficiency associated with tooth decay, excess of it causes fluorosis. Sources and requirement are of physiological importance. The metabolic role and deficiency disorders are important for the students of health sciences.

Vitamins and trace elements are particularly important for patients with gastrointestinal disorders, who are fed on artificial diets or parenteral nutrition.

Hormones

Hormones are chemical messengers secreted by endocrine glands and specific tissues. They reach distant organs and stimulate or inhibit the function. They play important role in carrying messages to the various organs. They form part of a signaling system.

Hormones are synthesized in one tissue, secreted in to blood, transported as mobile messengers .When they reach target tissue, they exhibit their actions. Defect in the secretion, function, metabolism can lead to various diseases.

Molecular Biology

Human beings are highly developed species. How a person looks, behaves, suffers from diseases and the like are dictated by genetic material called DNA. The information is inherited from parent to offspring. The same is replicated from parent DNA to daughter DNA.

Individual characters are translated in to proteins, under the direction of DNA. First RNA is synthesized from DNA (Transcription) which is translated in to Proteins. These proteins are responsible for various metabolic functions. Protein expression during development, adaptation, aging and other related processes of life are controlled by DNA.

Changes in the genetic material cause hereditary diseases.

UNIT ONE

ENZYMES

General Properties

Enzymes are protein catalysts for chemical reaction in biological systems. They increase the rate of chemical reactions taking place within living cells without changing themselves.

Nature of Enzymes

Most enzymes are protein in nature. Depending on the presence and absence of a non-protein component with the enzyme enzymes can exist as, simple enzyme or holoenzyme

1. Simple enzyme: It is made up of only protein molecules not bound to any non-proteins. Example: Pancreatic Ribonuclease.
2. Holo enzyme is made up of protein groups and non-protein component.
 - The protein component of this holo enzymes is called **apoenzyme**
 - The non-protein component of the holo enzyme is called a **cofactor**.

If this cofactor is an organic compound it is called a **coenzyme** and if it is an inorganic group it is called **activator**. (Fe^{2+} , Mn^{2+} , or Zn^{2+} ions).

If the cofactor is bound so tightly to the apoenzyme and is difficult to remove without damaging the enzyme it is sometimes called a **prosthetic group**

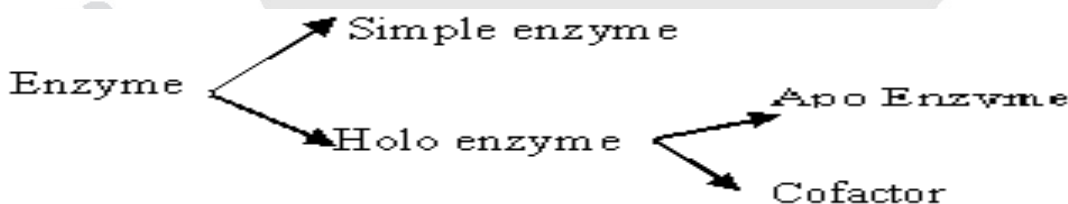

COENZYMES-

Coenzymes are derivatives of vitamins without which the enzyme cannot exhibit any reaction. One molecule of coenzyme is able to convert a large number of substrate molecules with the help of enzyme.

- Coenzyme accepts a particular group removed from the substrate or donates a particular group to the substrate
- Coenzymes are called co substrate because the changes that take place in substrates are complementary to the changes in coenzymes.

- The coenzyme may participate in forming an intermediate enzyme-substrate complex

Example: **NAD, FAD, Coenzyme A**

Metal ions in enzymes

Many enzymes require metal ions like Ca^{2+} , K^+ , Mg^{2+} , Fe^{2+} , Cu^{2+} , Zn^{2+} , Mn^{2+} and Co^{2+} for their activity.

Metal-activated enzymes form only loose and easily dissociable complexes with the metal and can easily release the metal without denaturation. Metalloenzymes hold the metal tightly on the molecule and do not release it even during extensive purification.

Metal ions promote enzyme action by

- a. Maintaining or producing the active structural conformation of the enzyme (e.g. glutamine synthase)
- b. Promoting the formation of the enzyme-substrate complex (Example: Enolase and carboxypeptidase A.)
- c. Acting as electron donors or acceptors (Example: Fe-S proteins and cytochromes)
- d. Causing distortions in the substrate or the enzyme (Example: phosphotransferases).

Properties of Enzyme

A. Active site

Enzyme molecules contain a special pocket or cleft called the active site. The active site contains amino acid chains that create a three-dimensional surface complementary to the substrate.

The active site binds the substrate, forming an enzyme-substrate (ES) complex. ES is converted to enzyme-product (EP); which subsequently dissociates to enzyme and product.

For the combination with substrate, each enzyme is said to possess one or more active sites where the substrate can be taken up.

The active site of the enzyme may contain free hydroxyl group of serine, phenolic (hydroxyl) group of tyrosine, SH-thiol (Sulfhydryl) group of cysteine or imidazole group of histidine to interact with their substrates.

It is also possible that the active site (Catalytic site) is different from the binding site in which case they are situated closely together in the enzyme molecule.

B. Catalytic efficiency/ Enzyme turnover number

Most enzyme- catalyzed reactions are highly efficient proceeding from 10^3 to 10^8 times faster than uncatalyzed reactions. Typically each enzyme molecule is capable of transforming 100 to 1000 substrate molecule in to product each second.

Enzyme turn over number refers to the amount of substrate converted per unit time (carbonic anhydrase is the fastest enzyme).

C. Specificity

Enzymes are specific for their substrate. Specificity of enzymes are divided into:

- a. Absolute specificity:- this means one enzyme catalyzes or acts on only one substrate. For example: Urease catalyzes hydrolysis of urea but not thiourea.
- b. Stereo specificity- some enzymes are specific to only one isomer even if the compound is one type of molecule:

For example: glucose oxidase catalyzes the oxidation of β -D-glucose but not α -D-glucose, and arginase catalyzes the hydrolysis of L-arginine but not D-arginine.

*Maltase catalyzes the hydrolysis of α - but not β –glycosides.

Bond Specificity

* Enzymes that are specific for a bond or linkage such as ester, peptide or glycosidic belong to this group

Examples:

1. Esterases- acts on ester bonds
2. Peptidases-acts on peptide bonds
3. Glycosidases- acts on glycosidic bonds.

D. Regulation

Enzyme activity can be regulated- that is, enzyme can be, activated or inhibited so that the rate of product formation responds to the needs of the cell.

E. Zymogens (- inactive form of enzyme)

Some enzymes are produced in nature in an inactive form which can be activated when they are required. Such type of enzymes are called Zymogens (Proenzymes).

Many of the digestive enzymes and enzymes concerned with blood coagulation are in this group

Examples: Pepsinogen - This zymogen is from gastric juice. When required

Pepsinogen converts to Pepsin

Trypsinogen - This zymogen is found in the pancreatic juice, and when it is required gets converted to trypsin.

* The activation is brought about by specific ions or by other enzymes that are proteolytic.

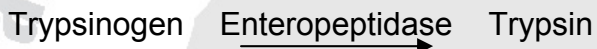
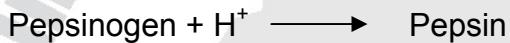

Zymogen forms of enzymes a protective mechanism to prevent auto digestion of tissue producing the digestive enzymes and to prevent intravascular coagulation of blood.

F. Isoenzymes (Isozymes)

These are enzymes having similar catalytic activity, act on the same substrate and produces the same product but originated at different site and exhibiting different physical and chemical characteristics such as electrophoretic mobilities, amino acid composition and immunological behavior.

Example: LDH (Lactate dehydrogenase) exists in five different forms each having four polypeptide chains. H= Heart and M=Muscle.

<u>Type</u>	<u>Polypeptide chain</u>
LDH-1	H H H H
LDH-2	H H H M
LDH-3	H H M M
LDH-4	H M M M
LDH-5	M M M M

Example. CPK (Creatine phospho kinase) exists in three different forms each having two polypeptide chains. Characteristic sub units are B=Brain and M= Muscle.

Type	Polypeptide chain
CPK-1	BB
CPK-2	MB
CPK-3	M

Classification of Enzymes

Enzymes are classified on the basis of the reactions they catalyze- Each enzyme is assigned a four-digit classification number and a systematic name, which identifies the reaction catalyzed.

The international union of Biochemistry and Molecular Biology developed a system of nomenclature on which enzymes are divided in to six major classes, each with numerous sub groups. Enzymes are classified based on the reactions they catalyze.

Each enzyme is characterized by a code number comprising four digits separated by points. The four digits characterize class, sub-class, sub-sub-class, and serial number of a particular enzyme.

Class I. Oxidoreducases-

Enzymes catalyzing oxidation reduction reactions.

Example: Lactate-dehydrogenase

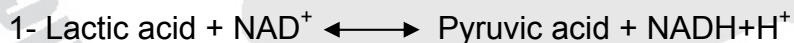

Class II. Transferases:

Enzymes catalyzing a transfer of a group other than hydrogen (methyl, acyl, amino or phosphate groups)

Example: Enzymes catalyzing transfer of phosphorus containing groups.

ATP: D-hexose-6 phosphotransferase (Hexokinase)



Example: Acetyl-CoA: Choline D-acyltransferase (Choline Acyltransferase)

Class III. Hydrolases: Enzymes catalyzing hydrolysis of ester, ether, peptido, glycosyl, acid-anhydride, C-C, C-halide, or P-N-bonds by utilizing water.

Example: Enzymes action on glycosyl compounds

β -D- Galactoside galactohydrolase (β -Galactosidase)

$\alpha \beta$ -D- Galactoside+H₂O \longrightarrow alcohol +D-Galactose

Class IV. Lyases: Enzymes that catalyze removal of groups from substances by mechanisms other than hydrolysis, leaving double bonds.

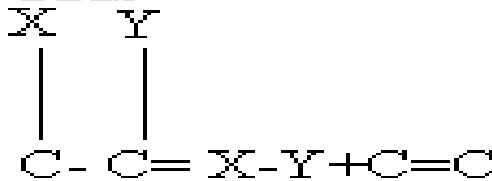

Enzymes acting on C-C, C-O, C-N, C-S and C-halide bonds.

Example : Carbon-Oxygen lyases

Malate hydro-lyase (Fumarase)

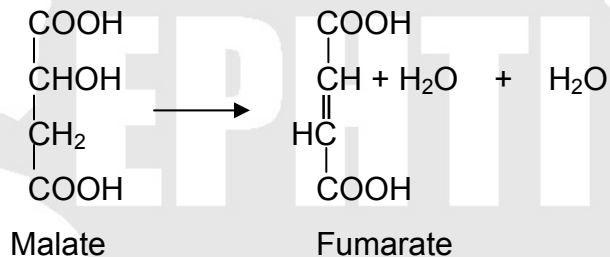

Class V. Isomerases:

Includes all enzymes catalyzing interconversion of optical, geometric, or positional isomers.

Example: Enzymes catalyzing interconversion of aldose and ketoses

D - Glyceraldehyde-3- phosphate ketoisomerase (triosephosphate isomerase)

D - Glyceraldehyde-3phosphate \longrightarrow Dihydroxyacetone phosphate.

Class VI. Ligases or synthetases.

Enzymes catalyzing the linking together of 2 compounds coupled to the breaking of a pyrophosphate bond in ATP or similar trinucleotides: GTP, UTP etc. included are enzymes catalyzing reactions forming C-O, C-S, C-N, and C-C bonds,

Example: Enzymes catalyzing formation of C-N-bonds

L- Glutamine: ammonia ligase (ADP) [Glutamine Synthetase]

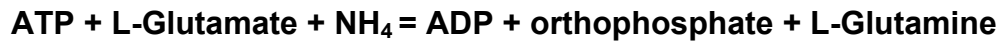

Example: Enzymes catalyzing formation of C-C bonds



MECHANISM OF ACTION OF ENZYMES

Emil Fischer's model Lock and Key model 1890.

Lock: Key model of enzyme action implies that the active site of the enzyme is complementary in shape to that of its substrate, i.e. the shape of the enzyme molecule and the substrate molecule should fit each other like a lock and Key

In 1958, Daniel Koshland, postulated another model; which implies that the shapes & the active sites of enzymes are complementary to that of the substrate only after the substrate is bound.

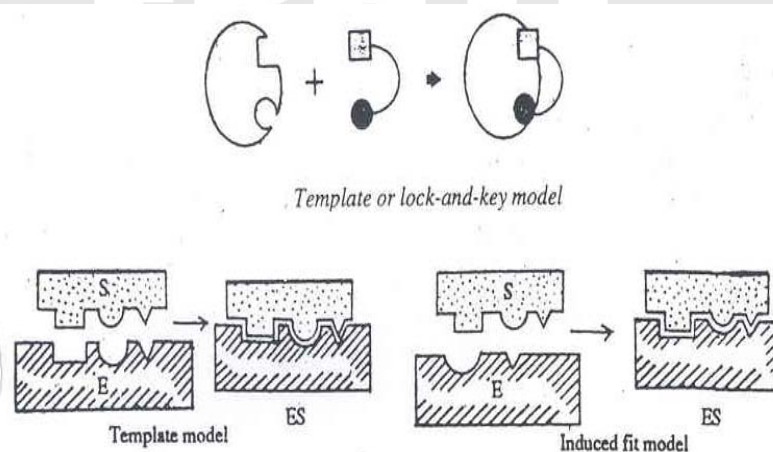

Figure: **Models of enzyme- substrate interactions**

Mechanism of Enzyme Action (1913)

Michaels and Menten have proposed a hypothesis for enzyme action, which is most acceptable. According to their hypothesis, the enzyme molecule (E) first combines with a substrate molecule (S) to form an enzyme substrate (ES) complex which further

dissociates to form product (P) and enzyme (E) back. Enzyme once dissociated from the complex is free to combine with another molecule of substrate and form product in a similar way.

ENZYMES ENHANCE THE RATE OF REACTION BY LOWERING FREE ENERGY OF ACTIVAION

A chemical reaction $S \rightarrow P$ (where S is the substrate and P is the product or products) will take place when a certain number of S molecules at any given instant possess enough energy to attain an activated condition called the “**transition state**”, in which the probability of making or breaking a chemical bond to form the product is very high.

The transition state is the top of the energy barrier separating the reactants and products. The rate of a given reaction will vary directly as the number of reactant molecules in the transition state. The “energy of activation is the amount of energy required to bring all the molecules in 1 gram-mole of a substrate at a given temperature to the transition state

A rise in temperature, by increasing thermal motion and energy, causes an increase in the number of molecules on the transition state and thus accelerates a chemical reaction. Addition of an enzyme or any catalyst can also bring about such acceleration.

The enzyme combines transiently with the substrate to produce a transient state having a lower energy of activation than that of substrate alone. This results in acceleration of the reaction. Once the products are formed, the enzyme (or catalyst) is free or regenerated to combine with another molecule of the substrate and repeat the process.

Activation energy is defined as the energy required to convert all molecules in one mole of reacting substance from the ground state to the transition state.

Enzymes are said to reduce the magnitude of this activation energy.

* During the formation of an ES complex, the substrate attaches itself to the specific active sites on the enzyme molecule by Reversible interactions formed by Electrostatic bonds, Hydrogen bonds, Vanderwaals forces, Hydrophobic interactions.

Factors Affecting Enzyme Activity

Physical and chemical factors are affecting the enzyme activity. These include

1. Temperature
2. pH
3. Substrate/enzyme concentration etc.

Temperature

Starting from low temperature as the temperature increases to certain degree the activity of the enzyme increases because the temperature increase the total energy of the chemical system .

There is an optimal temperature at which the reaction is most rapid (maximum). Above this the reaction rate decreases sharply, mainly due to denaturation of the enzyme by heat.

The temperature at which an enzyme shows maximum activity is known as the optimum temperature for the enzyme. For most body enzymes the optimum temperature is around 37⁰c, which is body temperature.

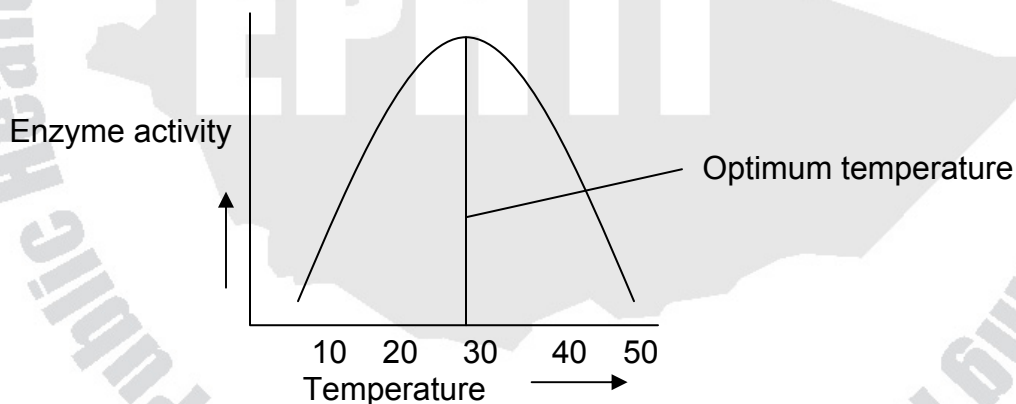

Figure. **Effect of temperature on enzymatic reaction**

1. Effect of pH

The concentration of H⁺ affects reaction velocity in several ways. First, the catalytic process usually requires that the enzyme and substrate have specific chemical groups in an ionized or unionized state in order to interact.

For example, Catalytic activity may require that an amino-group of the enzyme be in the protonated form ($-\text{NH}_3^+$) At alkaline pH this group is deprotonated and the rate of reaction therefore declines.

Extreme pH can also lead to denaturation of the enzyme, because the structure of the catalytically active protein molecule depends on the ionic character of the amino acid chains.

The pH at which maximum enzyme activity is achieved is different for different enzymes, and after reflects the pH] at which the enzyme functions in the body.

For example, pepsin, a digestive enzyme in the stomach, has maximum action at pH 2, where as other enzymes, designed to work at neutral pH, are denatured by such an acidic environment.

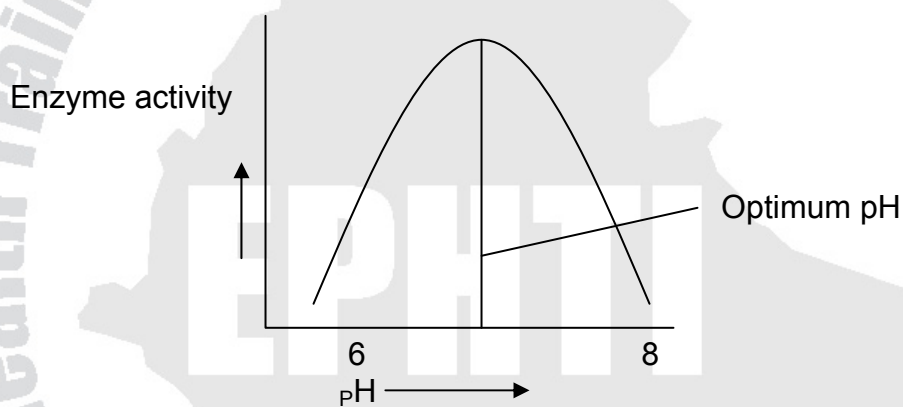

Figure. **Effect of pH on enzymatic reaction**

3. Concentration of substrate

At fixed enzyme concentration pH and temperature the activity of enzymes is influenced by increase in substrate concentration.

An increase in the substrate concentration increases the enzyme activity till a maximum is reached. Further increase in substrate concentration does not increase rate of reaction.

This condition shows that as concentration of substrate is increased, the substrate molecule combine with all available enzyme molecules at their active site till not more active sites are available (The active Sites become saturated). At this state the enzyme is obtained it maximum rate (V_{max}).

$V_o = \frac{1}{2} V_{max}$, at 50% saturation

$$\frac{1}{2} V_{max} = \frac{V_{max}[S]}{K_m + [S]}$$

$$K_m + [S]$$

$$2[S] = K_m + [S]$$

$$K_m = [S]$$

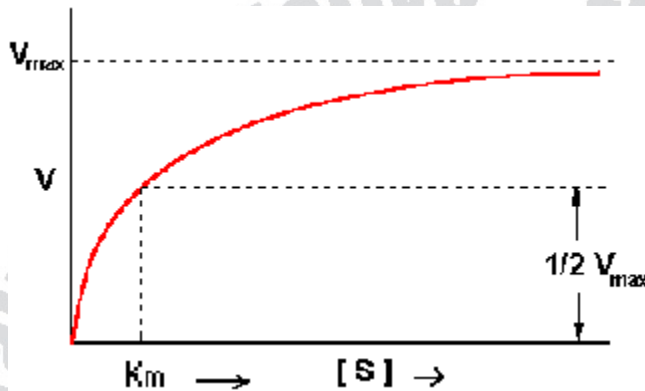

Figure: Relationship between [S] and K_m

Characteristics of K_m

K_m - can be defined as the concentration of the substrate at which a given enzyme yields one-half its maximum velocity (i.e. K_m is numerically equal to the substrate concentration at which the reaction velocity is equal to $\frac{1}{2} V_{max}$)

K_m - is characteristic of an enzyme and a particular substrate, and reflects the affinity of the enzyme for that substrate.

K_m - values vary from enzyme to enzyme and are used to characterize different enzymes.

K_m - values of an enzyme help to understand the nature and speed of the enzyme catalysis.

Small K_m - A numerically small (low) k_m reflects a high affinity of the enzyme for substrate because a low concentration of substrate is needed to half-saturate the enzyme - that is, to reach a velocity of $\frac{1}{2} V_{max}$.

High K_m - A numerically large (high) K_m reflects a low affinity of enzyme for substrate because a high concentration of substrate is needed to half-saturate the enzyme.

High K_m Value of an enzyme means the catalysis of that enzyme is slow compared to low K_m .

K_m does not vary with the concentration of enzyme.

4. Relationship of Velocity to Enzyme Concentration

The rate of the reaction is directly proportional to enzyme concentration at all substrate concentration. For example, if the enzyme concentration halved, the initial rate of the reaction (V_o) is reduced to one half that of the original.

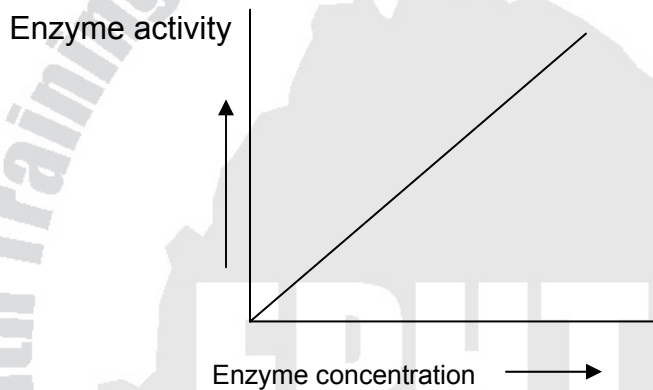

Figure. **Effect of Enzyme concentration on enzymatic reaction**

Order of Reaction

When $[S]$ is much less than K_m , the velocity of the reaction is roughly proportional to the substrate concentration. The rate of reaction is then said to be first order configuration with respect to substrate. When $[S]$ is much greater than K_m , the velocity is constant and equal to V_{max} . The rate of reaction is then independent of substrate concentration and said to be zero order with respect to substrate concentration.

Enzyme Inhibition

Any substance that can diminish the velocity of an enzyme-catalyzed reaction is called an inhibitor and the process is known as inhibition.

There are two major types of enzyme inhibition, Irreversible and Reversible.

Irreversible Inhibition

The type of inhibition that can not be reversed by increasing substrate concentration or removing the remaining free inhibitor is called Irreversible inhibition

Eg. Diisopropyl & fluorophosphate (DFP) Inhibits the enzyme acetyl cholinesterase, important in the transmission of nerve impulses. Acetyl cholinesterase catalyzes the hydrolysis of Acetylcholin (to acetic acid and choline) a neurotransmitter substance functioning in certain portions of the nervous system

- DEP inhibits also trypsin, chymotrypsin elastase, and phosphoglucomutase
Organo-phosphorus compounds like malathion, parathion pesticides-inhibits acetyl cholinesterase by the same way as DFP.

Example: Inhibition of triose phosphate dehydrogenase by iodo acetate which block the activity of the enzyme.

REVERSIBLE INHIBITION

This type of inhibition can be Competitive, Non-competitive and uncompetitive

Competitive Inhibition: This type of inhibition occurs when the inhibitor binds reversibly to the same site that the substrate would normally occupy, therefore, competes with the substrate for that site.

In competitive inhibition the inhibitor and substrate compete for the same active site on the enzyme as a result of similarity in structure. The enzyme substrate complex will be broken down to products ($E+S \rightleftharpoons ES \rightarrow E+P$) whereas enzyme inhibitor complex; (EI) will not be broken down to products.

A classical example is Malonate that competes with succinate and inhibits the action of succinate dehydrogenase to produce fumarate in the Krebs cycle.

The enzyme can be also inhibited by oxalate and glutarate because of the similarity of this substance with succinate

Eg.2 Allopurinol used for the treatment of Gout

Allopurinol Inhibits Xanthine oxidase by competing with Uric acid precursors for the active site on the enzyme. This competition blocks the conversion of these precursors, and of hypoxanthine and xanthine, to uric acid and result in lower serum urate levels.

Inhibition of Enzyme Catalyzed Reactions

To avoid dealing with curvilinear plots of enzyme catalyzed reactions, biochemists Lineweaver and Burk introduced an analysis of enzyme kinetics based on the following rearrangement of the Michaelis-Menten equation:

$$\left[\frac{1}{v}\right] = \left[\frac{K_m}{V_{max}}\right] \left[\frac{1}{[S]}\right] + \left[\frac{1}{V_{max}}\right]$$

Plots of $1/v$ versus $1/[S]$ yield straight lines having a slope of K_m/V_{max} and an intercept on the ordinate at $1/V_{max}$.

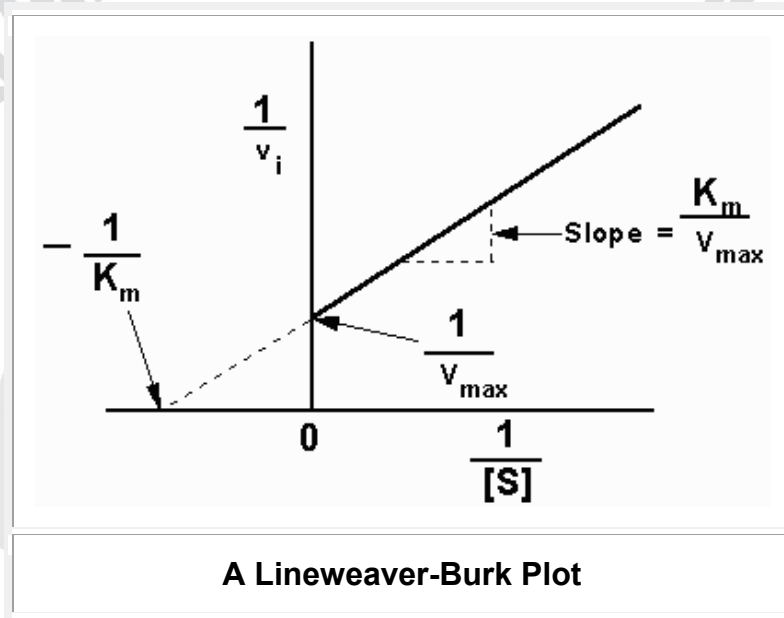

An alternative linear transformation of the Michaelis-Menten equation is the Eadie-Hofstee transformation:

$$v/[S] = -v [1/K_m] + [V_{max}/K_m]$$

and when $v/[S]$ is plotted on the y-axis versus v on the x-axis, the result is a linear plot with a slope of $-1/K_m$ and the value V_{max}/K_m as the intercept on the y-axis and V_{max} as the intercept on the x-axis.

Both the Lineweaver-Burk and Eadie-Hofstee transformation of the Michaelis-Menton equation are useful in the analysis of enzyme inhibition. Since most clinical drug therapy is based on inhibiting the activity of enzymes, analysis of enzyme reactions using the tools described above has been fundamental to the modern design of pharmaceuticals

Effect of Competitive inhibitors

1. Effect on V_{max} : The effect of a competitive inhibitor is reversed by increasing $[s]$. at a sufficiently high substrate concentration, the reaction velocity reaches the V_{max} observed in the absence of inhibitor.
2. Effect on K_m : A competitive inhibitor increases the apparent K_m for a given substrate. This means that in the presence of a competitive inhibitor more substrate is needed to achieve $\frac{1}{2} V_{max}$.

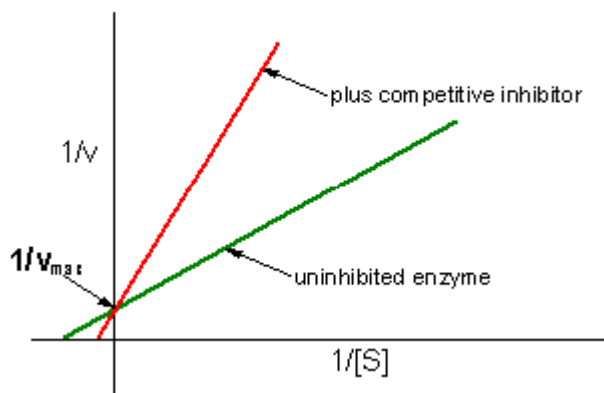

Figure: Competitive inhibition

Non-Competitive Inhibition

In non-competitive inhibition the inhibitor binds at different site rather than the substrate-binding site. When the inhibitor binds at this site there will be a change in conformation of the enzyme molecules, which leads to the reversible inactivation of the catalytic site. Non-competitive inhibitors bind reversibly either to the free-enzyme or the ES complex to form the inactive complexes EI and ESI (Enzyme substrate Inhibition)

The most important non-competitive inhibitors are naturally occurring metabolic intermediates that can combine reversibly with specific sites on certain regulatory enzymes, that changes the activity of their catalytic sites.

An Example: is the inhibition of L-threonine dehydratase by L-isoleucine.

*Such type of Enzyme is called Allosteric Enzyme, which has a specific sites or allosteric site other than the substrate-binding site.

1. Effect on Vmax.

Non-Competitive inhibition cannot be overcome by increasing the concentration of substrate. Thus, non-competitive inhibitors decrease the Vmax of the reaction.

2. Effect on Km:

Non-competitive inhibitors do not interfere with the binding of substrate to enzyme. Thus, the enzyme shows the same Km in the presence or absence of the non-competitive inhibitor.

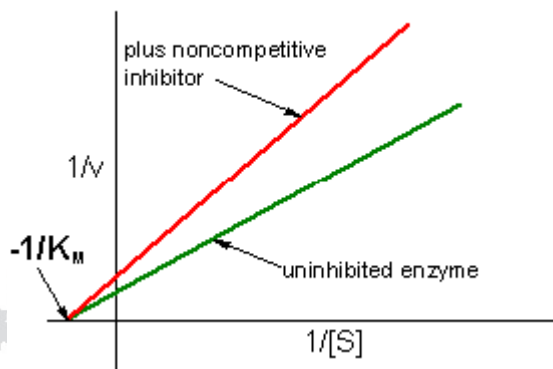

Figure: **Noncompetitive inhibition**

Uncompetitive Inhibition

Uncompetitive Inhibitor binds only to ES complex at locations other than the catalytic site. Substrate binding modifies enzyme structure, making inhibitor-binding site available. Inhibition cannot be reversed by substrate.

In this case apparent Vmax. and Km decreased.

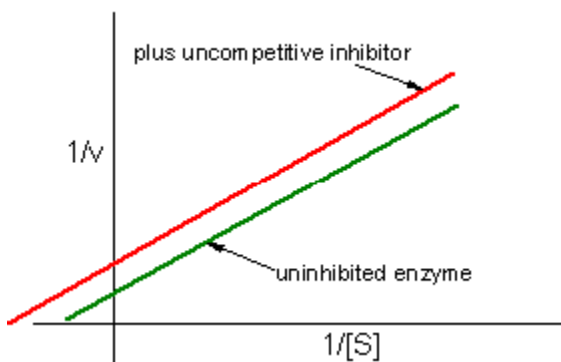

Figure: **Uncompetitive inhibition**

Regulation of enzyme activity

There are several means by which the activity of a particular enzyme is specifically regulated.

1. Irreversible covalent Activation / Zymogen activation

Some enzymes are secreted in an inactive form called Proenzymes or zymogens. At the site of action specific peptide bonds are hydrolysed either enzymatically or by PH changes to convert it into active form, e.g. Pepsinogen → pepsin, Trypsinogen → trypsin, plasminogen → plasmin. After hydrolysis when it is activated, it cannot be reconverted into proenzyme form.

2. Reversible Covalent Modification

By addition of or removal of phosphate or adenylate, certain enzymes are reversibly activated and inactivated as per the requirement. Protein kinase of muscle phosphorylate phosphorylase kinase, glycogen synthetase by making use of ATP.

3. Allosteric Modulation

In addition to simple enzymes that interact only with substrates and inhibitors, there is a class of enzymes that bind small, physiologically important molecules and modulate activity in ways other than those described above. These are known as **allosteric enzymes**; the small regulatory molecules to which they bind are known as **effectors**. Allosteric effectors bring about catalytic modification by binding to the enzyme at distinct allosteric sites, well removed from the catalytic site, and causing conformational changes that are transmitted through the bulk of the protein to the catalytically active site(s).

The hallmark of effectors is that when they bind to enzymes, they alter the catalytic properties of an enzyme's active site. Those that increase catalytic activity are known as positive effectors. Effectors that reduce or inhibit catalytic activity are negative effectors.

There are two ways that enzymatic activity can be altered by effectors: the V_{\max} can be increased or decreased, or the K_m can be raised or lowered.

4. Feedback inhibition

In allosteric regulation in which end products inhibit the activity of the enzyme is called "feedback inhibition".

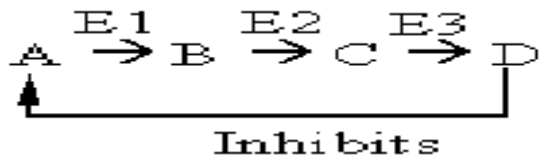

A high conc. D typically inhibits conversion of $A \rightarrow B$.

This involves not simple backing up of intermediates but the activity of D to bind to and inhibit E1. D thus acts as negative allosteric effector or feedback inhibitor of E1.

The kinetics of feedback inhibition can be competitive, mixed, etc. It is the commonest way of regulation of a biosynthetic pathway. Feedback regulation generally occurs at the earliest functionally irreversible step unique in the biosynthetic pathway.

ENZYMES IN CLINICAL DIAGNOSIS

Plasma enzymes can be classified into two major groups

1. Those, relatively, small group of enzymes secreted into the plasma by certain organs (i.e. Enzymes those have function in plasma) For example: - the liver secretes zymogens of the enzymes involved in blood coagulation.
2. Those large enzyme species released from cells during normal cell turnover. These enzymes are normally intracellular and have no physiologic function in the plasma. In healthy individuals the levels of these enzymes are fairly constant and represent steady state in which the rate of release from cells into the plasma is balanced by an equal rate of removal from the plasma.

Many diseases that cause tissue damage result in an increased release of intracellular enzymes into the plasma. The activities of many of these enzymes are routinely

determined for diagnostic purposes in diseases of the heart, liver, skeletal muscle, and other tissues. The level of specific enzyme activity in the plasma frequently correlates with the extent of tissue damage. Thus, the degree of elevation of a particular enzyme activity in plasma is often useful in evaluating the diagnosis and prognosis for the patient.

Measurement of enzymes concentration of mostly the latter type in plasma gives valuable information about disease involving tissues of their origin.

1. Lipase:

It is an enzyme catalyzing the hydrolysis of fats. It is secreted by pancreas and Liver. The plasma lipase level may be low in liver disease, Vitamin A deficiency, some malignancies, and diabetes mellitus. It may be elevated in acute pancreatitis and pancreatic carcinoma.

2. α - Amylase

α - amylase is the enzyme concerned with the break down of dietary starch and glycogen to maltose. It is present in pancreatic juice and saliva as well as in liver fallopian tubes and muscles. The enzyme is excreted in the Urine. The main use of amylase estimations is in the diagnosis of acute pancreatitis. The plasma amylase level may be low in liver disease and increased in high intestinal obstruction, mumps, acute pancreatitis and diabetes.

3. Trypsin

Trypsin is secreted by pancreas. Elevated levels of trypsin in plasma occur during acute pancreatic disease.

4. Alkaline phosphates (ALP)

The alkaline phosphates are a group of enzymes, which hydrolyze phosphate esters at an alkaline pH. They are found in bone, liver, kidney, intestinal wall, lactating mammary gland and placenta. In bone the enzyme is found in osteoblasts and is probably

important for normal bone function. The level of these enzymes may be increased in rickets and osteomalacia, hyperparathyroidism, paget's disease of bone, obstructive jaundice, and metastatic carcinoma. Serum alkaline phosphatase levels may be increase in congestive heart failure result of injury to the liver.

5. Acid Phosphatase (ACP)

Acid phosphatases catalyzing the hydrolysis of various phosphate esters at acidic pH is found in the prostate, liver, red cells, platelets and bone. It may be elevated in metastatic prostatic carcinoma.

6. Transaminases

Two transaminases are of clinical interest.

1. Aspartate Transaminase, AST (Glutamate oxaloacetate transaminase, GOT) catalyzes the transfer of the amino group of aspartic acid to α - ketoglutarate forming glutamate and oxaloacetate.

AST or GOT is widely distributed, with high concentration, in the heart, liver, skeletal muscle, kidney and erythrocytes, and damage to any of these tissues may cause raised levels.

2. Alanine transaminase, ALT (Glutamate pyruvate transaminase, GPT)

Transfer the amino group of alanine to α - ketoglutarate, forming glutamate and pyruvate. It is present in high concentration in liver and to a lesser extent in skeletal muscle, kidney and heart.

- Serum levels of glutamate- pyruvate transaminase (SGOT) and Glutamate-oxaloacetate- transaminase (SGOT) are useful in the diagnosis of liver parenchymal damage and myocardial damage respectively. In liver damage, both enzymes are increased, but SGPT increases more. In myocardial infarction SGOT is increased with little or no increase in SGPT.

7. Lactate Dehydrogenase (LDH)

It catalyzes the reversible interconversion of lactate and pyruvate. It is widely distributed with high concentrations in the heart, skeletal muscle, liver, kidney, brain and erythrocytes.

The enzyme is increased in plasma in myocardial infarction, acute leukemias, generalized carcinomatosis and in acute hepatitis. Estimation of its isoenzymes is more useful in clinical diagnosis to differentiate hepatic disease and myocardial infarction.

8. Creatine kinase (CK) or creatine phosphokinase (CPK)

CK (CPK) is found in heart muscle, brain and skeletal muscle. Measurement of serum creatine phosphokinase activity is of value in the diagnosis of disorders affecting skeletal and cardiac muscle. The level of CPK in plasma is highly increased in myocardial infarction.

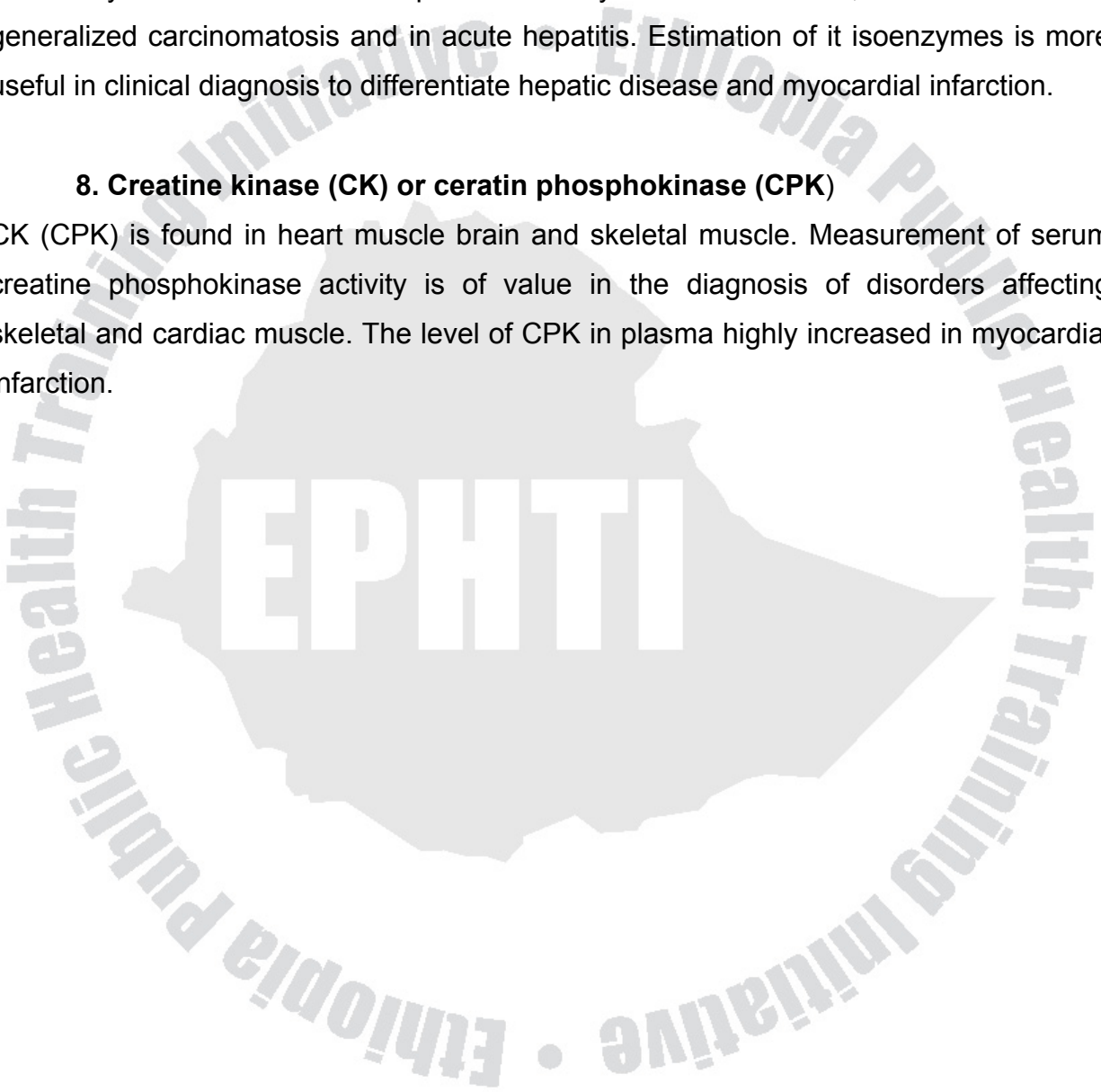

UNIT TWO

CARBOHYDRATS

Objectives

- Define carbohydrates in chemical terms
- Classify carbohydrates in to three major groups with examples of each group
- List the monosaccharides of biological importance and learn their properties
- List the disaccharides of biological importance and learn their properties
- List the polysaccharides of biological importance and learn their properties
- Study the chemistry and functions of glycoproteins

Introduction

Carbohydrates are the most abundant macromolecules in nature. They are the main source and storage of energy in the body. They serve also as structural component of cell membrane. The general molecular formula of carbohydrate is $C_nH_{2n}O_n$ or $(CH_2O)_n$, where $n \geq 3$. Chemically, they contain the elements Carbon, hydrogen and oxygen. Thus they are Carbon compounds that contain large quantities of Hydroxyl groups.

Carbohydrates in general are polyhydroxy aldehydes or ketones or compounds which give these substances on hydrolysis.

Chemistry of Carbohydrates

Classification and Structure

Classification

There are three major classes of carbohydrates

- Monosaccharides (Greek, mono = one)
- Oligosaccharides (Greek, oligo= few) 2-10 monosaccharide units.
- Polysaccharides (Greek, Poly = many) >10 monosaccharide units.

Monosaccharides

Monosaccharides also called simple sugars. They consist of a single polyhydroxy aldehyde or ketone units. The most abundant monosaccharides in nature are the 6-carbon sugars like D-glucose and fructose.

Physical properties

Physical properties of Monosaccharides

They are colorless, crystalline compounds, readily soluble in water. Their solutions are optically active and exhibit the phenomenon of mutarotation. Carbohydrates spontaneously change between the α and β configuration.

Asymmetric Center and Stereoisomerism

Asymmetric carbon is a carbon that has four different groups or atoms attached to it and having optical activity in solution.

All the monosaccharides except dihydroxyacetone contain one or more asymmetric or chiral carbon atoms and thus occur in optically active isomeric forms. Monosaccharides with n number of asymmetric centers will have (2^n) isomeric forms. (n = number of asymmetric carbon atoms).

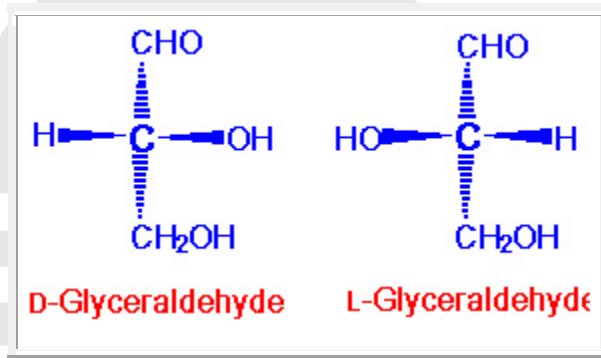

Fig 2.2: The two isomeric forms of glyceraldehyde.

The designation of a sugar isomer as the D- form or of its mirror images the L- form is determined by the spatial relationship to the parent compound of the carbohydrate family. The D and L forms of Glyceraldehyde are shown in the Figure 2.2. The orientation of - OH and - H groups around the carbon atom adjacent to the terminal primary alcohol carbon determines its D or L form. When the - OH group on this carbon is on the right, the sugar is a member of the D-series, when it is on the left, it is a member of the L-series. These D and L configuration are also called Enantiomers.

Optical Activity

The presence of asymmetric carbon atom causes optical activity. When a beam of plane-polarized light is passed through a solution of carbohydrate it will rotate the light either to right or to left. Depending on the rotation, molecules are called dextrorotatory (+) (d) or levorotatory (-) (l). Thus, D- glucose is dextrorotatory but D- fructose is levorotatory. When equal amounts of D

and L isomers are present, the resulting mixture has no optical activity, since the activities of each isomer cancel one another. Such a mixture is called racemic or DL mixture.

Epimers

When sugars are different from one another, only in configuration with regard to a single carbon atom (around one carbon atom) they are called **epimers** of each other. For example glucose and mannose are epimers. They differ only in configuration around C₂. Mannose and Galactose are epimers of Glucose

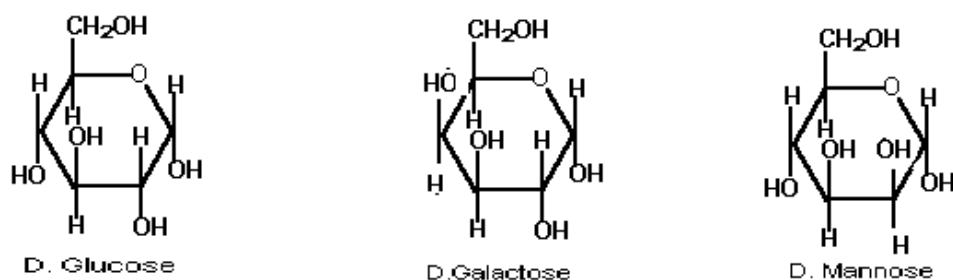

Fig 2.3: Structure of D - glucose, D-mannose and D- Galactose.

Anomers

The two stereoisomers at the hemiacetal (anomeric) carbon are:

- The alpha anomer: Where- OH group is down (Haworth)
- The beta anomer: Where- OH group is up (Haworth)
- Anomers are diastereomers (having different physical properties)

Cyclization of monosaccharides

Monosaccharides with five or more carbon atoms in the backbone usually occur in solution as cyclic or ring structure, in which the carbonyl group is not free as written on the open chain structure but has formed a covalent bond with one of the hydroxyl group along the chain to form a hemiacetal or hemiketal ring. In general, an aldehyde can react with an alcohol to form a hemiacetal or acetal.

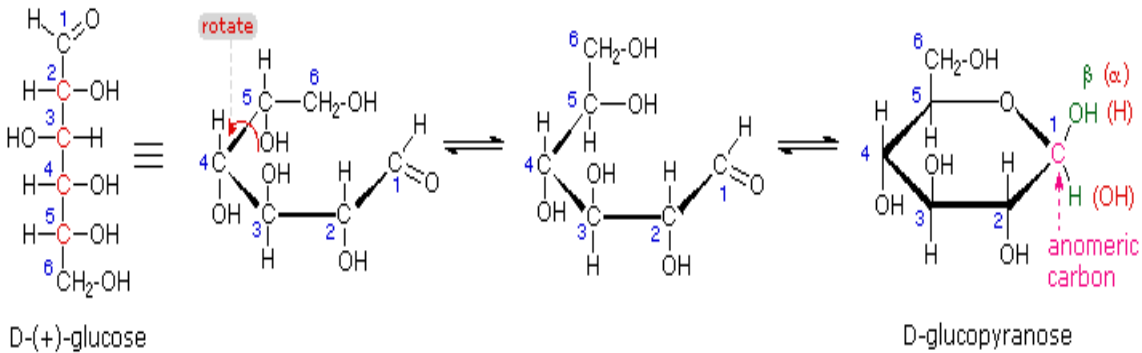

The C-1 aldehyde in the open-chain form of glucose reacts with the -5th carbon atom containing hydroxyl group to form an intramolecular hemiacetal. The resulting six membered ring is called pyranose because of its similarity to organic molecule Pyran.

Two different forms of glucose are formed when the OH group extends to right it is α -D-Glucose and when it extends to left, it is β -D-Glucose commonly called as Anomers.

Similarly, a ketone can react with an alcohol to form a hemiketal or ketal.

The C-2 keto group in the open chain form of fructose can react with the 5th carbon atom containing hydroxyl group to form an intramolecular hemiketal. This five membered ring is called furanose because of its similarity to organic molecule furan



Fig 2.4. α and β forms of Fructose

Oligosaccharides

Oligosaccharides contain 2 to 10 monosaccharide units. The most abundant oligosaccharides found in nature are the Disaccharides.

Disaccharides

When two monosaccharides are covalently bonded together by glycosidic linkages a disaccharide is formed. Glycosidic bond is formed when the hydroxyl group on one of the sugars reacts with the anomeric carbon on the second sugar.

Biologically important disaccharides are sucrose, maltose, and Lactose.

Maltose

Maltose contains two D glucose residues joined by a glycosidic linkage between OH at the first carbon atom of the first glucose residues and OH at the fourth carbon atom of the second glucose forming a α -(1,4) glycosidic linkage as shown in Figure below. Maltose is the major degradative product of Starch. Maltose is hydrolyzed to two molecules of D- glucose by the intestinal enzyme maltase, which is specific for the α -(1,4) glycosidic bond.

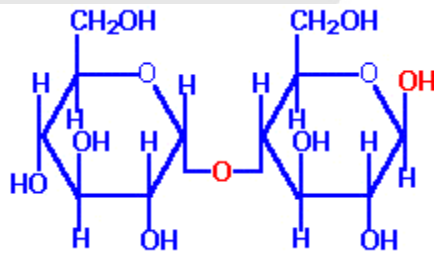

Fig 2.5. Structure of Maltose

Lactose

Lactose is a disaccharide of β -D galactose and β -D- glucose which are linked by β -(1,4) glycosidic linkage. Lactose acts as a reducing substance since it has a free carbonyl group on the glucose. It is found exclusively in milk of mammals (Milk sugar).

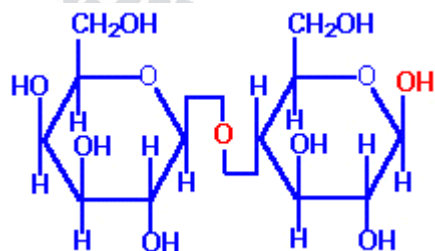

Figure 2.6: Structure of Lactose

Sucrose (Cane sugar)

Sucrose is a disaccharide of α -D-glucose and β -D-fructose. It is obtained from cane sugar. It is also present in various fruits. In contrast to other disaccharides sucrose contains no free anomeric carbon atom. Since the anomeric carbons of both its component monosaccharide units are linked to each other. For this reason sucrose is non reducing sugar.

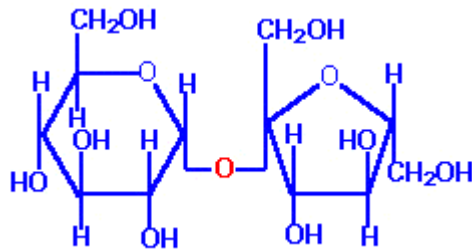

Fig 2.7. Structure of sucrose α -(1, 2) β -Glycosidic bond

Polysaccharides

Most of the carbohydrates found in nature occur in the form of high molecular polymers called polysaccharides.

There are two types of polysaccharides. These are:

- Homopolysaccharides that contain only one type of monosaccharide building blocks.
- Heteropolysaccharides, which contain two or more different kinds monosaccharide building blocks.

Homopolysaccharides

Example of Homopolysaccharides: Starch, glycogen, Cellulose and dextrans.

Starch

It is one of the most important storage polysaccharide in plant cells. It is especially abundant in tubers, such as potatoes and in seeds such as cereals.

Starch consists of two polymeric units made of glucose called Amylose and Amylopectin but they differ in molecular architecture.

Amylose is unbranched with 250 to 300 D-Glucose units linked by α -(1, 4) linkages Amylopectin consists of long branched glucose residue (units) with higher molecular weight.

The inner part of glucose units in amylopectin are joined by α -(1,4) glycosidic linkage as in amylose, but the branch points of amylopectin are α -(1,6) linkages. The branch points repeat about every 20 to 30 (1-4) linkages

Glycogen

- Glycogen is the main storage polysaccharide of animal cells (Animal starch).
- It is present in liver and in skeletal muscle.
- Like amylopectin glycogen is a branched polysaccharide of D-glucose units in α -(1,4) linkages, but it is highly branched.
- The branches are formed by α -(1,6) glycosidic linkage that occurs after every 8-12 residues. Therefore liver cell can store glycogen within a small space. Multiple terminals of branch points release many glucose units in short time.

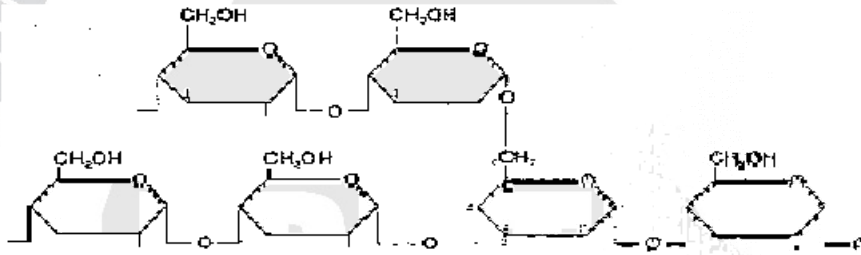

Cellulose

Cellulose is the most abundant structural polysaccharide in plants. It is fibrous, tough, water insoluble. Cellulose is a linear unbranched homopolysaccharide of 10,000 or more D-glucose units connected by β -(1,4) glycosidic bonds. Humans cannot use cellulose because they lack of enzyme (cellulase) to hydrolyze the β -(1,4) linkages.

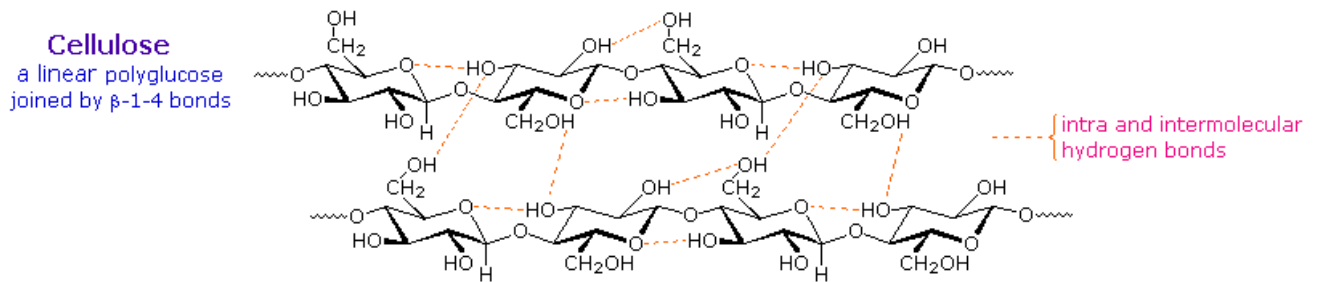

Figure: **Structure of Cellulose**

Dextrins

These are highly branched homopolymers of glucose units with α -(1, 6), α -(1, 4) and α -(1, 3) linkages. Since they do not easily go out of vascular compartment they are used for intravenous infusion as plasma volume expander in the treatment of hypovolumic shock.

Hetero polysaccharides

These are polysaccharides containing more than one type of sugar residues

1. Glycosaminoglycans, (GAGs or mucopolysaccharides)

They are long, usually unbranched, composed of a repeating disaccharide units

* They are negatively charged heteropolysaccharid chains (polyanions)

- The amino sugar is either D-glucosamine or D-galactosamine in which the amino group is usually acetylated, thus eliminating its positive charges.
- The amino sugar may also be sulfated on carbon 4, 6, or on a monoacetylated nitrogen.
- The acidic sugar is either D-glucuronic acid or its carbon 6 epimer, L-uronic acid. For example Hyaluronic acid, Heparin and chondatin sulphate.

Function of Glycosaminoglycans. (GAGS)

1. They have the special ability to bind large amounts of water, there by producing the gel-like matrix that forms the basis of the body's ground substance.
 2. Since they are negatively charged, for example, in bone, glycosaminoglycans attract and tightly bind cations like Ca^{++} , they also take-up Na^+ and K^+
 3. GAGs stabilize and support cellular and fibrous components of tissue while helping maintain the water and salt balance of the body.
 4. Its essential components of the extra cellular matrix, GAGs' play an important role in mediating cell-cell interactions
- Ground substance is a part of connective tissue, which is a gel like substance containing water, salt, proteins and polysaccharides.

An example of specialized ground substance is the synovial fluid, which serves as a lubricant in joints, and tendon sheaths.

3. Heparin:

- contains a repeating unit of D-glucuronic and D-gluconsamine, with sulfate groups on some of the hydroxyl and amino-groups
- It is an important anticoagulant, prevents the clotting of blood by inhibiting the conversion of prothrombin to thrombin. Thrombin is an enzyme that acts on the conversion of plasma fibrinogen into the fibrin.
- It is found in mast cells in lung, liver skin and intestinal mucosa.

Glycoproteins (Mucoproteins)

Glycoproteins are proteins to which oligosaccharides are covalently attached. They differ from the glycosaminoglycans in that the length of the glycoproteins carbohydrate chain is relatively short (usually two to ten sugar residues in length, although they can be longer), whereas it can be very long in the glycosaminoglycans.

The glycoprotein carbohydrate chains are often branched instead of linear and may or may not be negatively charged.

For example:

- Glycophorin, a glycoprotein found in human red cell membranes.
- Human gastric glycoprotein (mucin).
- Many protein hormones, receptors are glycoproteins

Proteoglycans

When glycosaminoglycans are attached to a protein molecule the compound is called proteoglycan [proteoglycans = Glycosaminoglycans + proteins]

METABOLISM OF CARBOHYDRATES

Objectives

- study utilization of glucose and other carbohydrates in the body
- study the various mechanisms and fate of glucose in the body
- study the energetics of the various mechanisms

Digestion of Carbohydrates

Dietary carbohydrates principally consist of the polysaccharides: starch and glycogen. It also contains disaccharides: sucrose, lactose, maltose and in small amounts monosaccharides like fructose and pentoses. Liquid food materials like milk, soup, fruit juice escape digestion in mouth as they are swallowed, but solid foodstuffs are masticated thoroughly before they are swallowed.

1. Digestion in Mouth

Digestion of carbohydrates starts at the mouth, where they come in contact with saliva during mastication. Saliva contains a carbohydrate splitting enzyme called salivary amylase (ptyalin).

Action of ptyalin (salivary amylase)

It is α -amylase, requires Cl^- ion for activation and optimum pH 6-7. The enzyme hydrolyzes α -(1,4) glycosidic linkage at random, from molecules like starch, glycogen and dextrans, producing smaller molecules maltose, glucose and disaccharides maltotriose. Ptyalin action stops in stomach when pH falls to 3.0

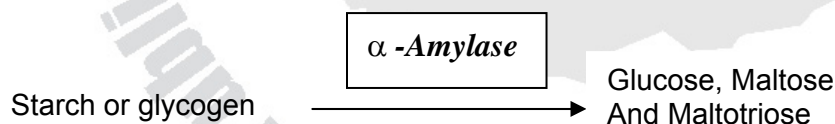

2. Digestion in Stomach

No carbohydrate splitting enzymes are available in gastric juice. HCl may hydrolyze some dietary sucrose to equal amounts of glucose and fructose.

3. Digestion in Duodenum

Food reaches the duodenum from stomach where it meets the pancreatic juice. Pancreatic juice contains a carbohydrate-splitting enzyme pancreatic amylase.

Action of pancreatic Amylase

It is also an α - amylase, optimum pH 7.1. Like ptyalin it also requires Cl^- for activity. The enzyme hydrolyzes α -(1,4) glycosidic linkage situated well inside polysaccharide molecule. Other criteria and end products of action are similar of ptyalin.

1. Digestion in Small Intestine

Action of Intestinal Juice

a. pancreatic amylase:

It hydrolyzes terminal α -(1,4), glycosidic linkage in polysaccharides and Oligosaccharide molecules liberating free glucose molecules.

b. Lactase

It is a β - glycosidase, its pH range is 5.4 to 6.0. Lactose is hydrolyzed to glucose and galactose.

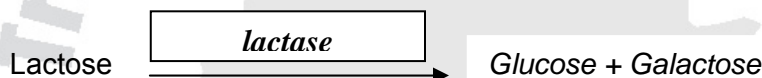

Lactose Intolerance

Lactose is hydrolyzed to galactose and glucose by lactase in humans (by β - Galactosidase in Bacteria). Some adults do not have lactase. Such adults cannot digest the sugar. It remains in the intestines and gets fermented by the bacteria. The condition is called as Lactose intolerance. Such patients suffer from watery diarrhea, abnormal intestinal flow and chloelic pain. They are advised to avoid the consumption of Lactose containing foods like Milk.

C. Maltase

The enzyme hydrolyzes the α -(1,4) glycosidic linkage between glucose units in maltose molecule liberating two glucose molecules. Its pH range is 5.8 to 6.2.

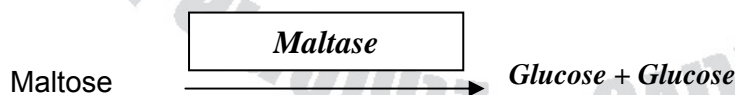

D. Sucrase

PH ranges 5.0 to 7.0. It hydrolyzes sucrose molecule to form glucose and fructose.

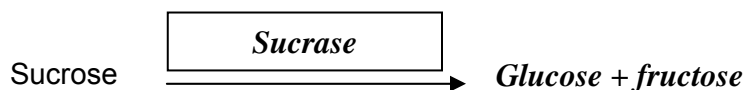

Absorption of Carbohydrates

Products of digestion of dietary carbohydrates are practically completely absorbed almost entirely from the small intestine.

Absorption from proximal jejunum is three times greater than that of distal ileum. It is also proved that some disaccharides, which escape digestion, may enter the cells of the intestinal lumen by "pinocytosis" and are hydrolyzed within these cells. No carbohydrates higher than the monosaccharides can be absorbed directly in to the blood stream.

Mechanism of Absorption

Two mechanisms are involved:

1. Simple Diffusion

This is dependent on sugar concentration gradients between the intestinal lumen and blood plasma. All the monosaccharides are probably absorbed to some extent by simple 'passive' diffusion.

2. "Active" Transport Mechanisms

- Glucose and galactose are absorbed very rapidly and hence it has been suggested that they are absorbed actively and it requires energy.
- Fructose absorption is also rapid but not so much as compared to glucose and galactose but it is definitely faster than pentoses. Hence fructose is not absorbed by simple diffusion alone and it is suggested that some mechanism facilitates its transport, called as "facilitated transport".

GLYCOLYSIS

Oxidation of glucose or glycogen to pyruvate and lactate is called glycolysis.

This was described by Embden, Meyerhoff and Parnas. Hence it is also called as Embden Meyerhoff pathway.

It occurs virtually in all tissues. Erythrocytes and nervous tissues derive its energy mainly from glycolysis. This pathway is unique in the sense that it can utilize O₂ if available ('aerobic') and it can function in absence of O₂ also ('anaerobic')

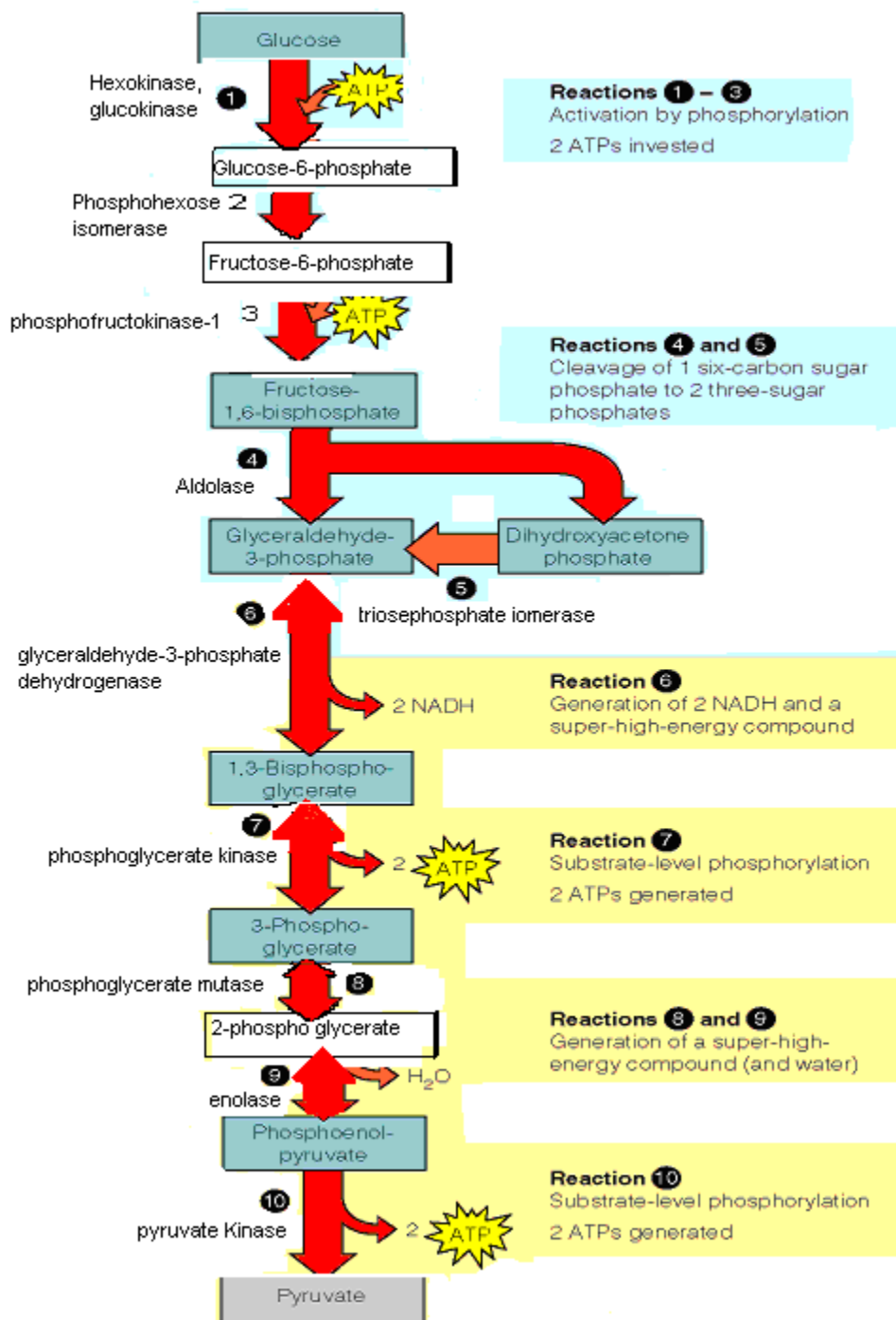

Fig 2.8: Glycolysis reactions

Aerobic Phase

Aerobic phase includes the conversion of glucose to pyruvate

Oxidation is carried out by dehydrogenation and reducing equivalent is transferred to NAD. NADH + H⁺ in presence of O₂ is oxidized in electron- transport chain producing ATP.

- **Anaerobic Phase**

This phase includes the conversion of Glucose to lactate

NADH cannot be oxidized, so no ATP is produced in electron transport chain. But the NADH is oxidized to NAD⁺ by conversion of pyruvate to Lactate, without producing ATP.

Anaerobic phase limits the amount of energy per molecule of glucose oxidized. Hence, to provide a given amount of energy, more glucose must undergo glycolysis under anaerobic as compared to aerobic.

A. Enzymes

Enzymes involved in glycolysis are present in cytoplasm.

SIGNIFICANCE OF THE PATHWAY:

- This pathway is meant for provision of energy.
- It has importance in skeletal muscle as glycolysis provides ATP even in absence of O₂, muscles can survive under anaerobic condition.

REACTIONS OF GLYCOLYTIC PATHWAY

Series of reactions of glycolytic pathway, which degrades glucose/ glycogen to pyruvate/lactate, are discussed below. For discussion and proper understanding, the various reactions can be arbitrarily divided in to four stages.

Stage I

This is preparatory stage, before the glucose molecule can be split; the rather asymmetric glucose molecule is converted to almost symmetrical form fructose 1, 6 bisphosphate in the presence of ATP.

1. Uptake of Glucose by Cells and its phosphorylation

Glucose is freely permeable to Liver cells. In Intestinal mucosa and kidney tubules, glucose is taken up by 'active' transport. In other tissues, like skeletal muscle, cardiac muscle, diaphragm, adipose tissue etc. Insulin facilitates the uptake of glucose. Glucose is then phosphorylated to form glucose – 6- Phosphate. The reaction is catalyzed by the specific enzyme glucokinase in liver cells and by nonspecific Hexokinase in liver and extrahepatic tissues.

- ATP acts as PO_4 donor in the presence of Mg. One high energy PO_4 bond is utilized and ADP is produced. The reaction is accompanied by considerable loss of free energy as heat, and hence under physiological conditions is regarded as irreversible.
- Glucose 6 phosphate formed is an important compound at the junction of several metabolic pathways like glycolysis, glycogenesis, glycogenolysis, glyconeogenesis, Hexosemonophosphate Shunt, uronic acid pathway. Thus is a “committed step” in metabolic pathways.

2. Conversion of G- 6- phosphate to Fructose6-phosphate

- Glucose6 phosphate after formation is converted to fructose 6-p by phospho- hexose isomerase, which involves an aldose- ketose isomerization. The enzyme can act only on α - anomer of Glucose 6 phosphate.

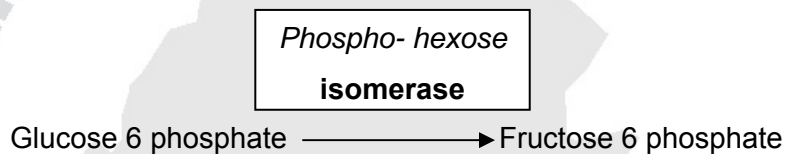

3. Conversion of Fructose 6phosphate to Fructose 1, 6 bisphosphate

The above reaction is followed by another phosphorylation. Fructose-6-p is phosphorylated with ATP at 1- position catalyzed by the enzyme phospho- fructokinase-1 to produce the symmetrical molecule fructose –1, 6 bis phosphate.

Note:

- reaction one is irreversible
- One ATP is utilized for phosphorylation of glucose at position 6
- Phosphofruvctokinase I is the key enzyme in glycolysis that regulates the pathway. The enzyme is inducible, as well as allosterically modified
- Phosphofructokinase II is an is enzyme which catalyzes the reaction to form fructose-2 6- bis phosphate.



Energetics

Note that in this stage glucose oxidation does not yield any useful energy rather there is expenditure of 2 ATP molecules for two phosphorylations (-2 ATP).

Stage II

Here, Fructose, 1, 6- biphosphate is split by the enzyme aldolase into two molecules of triose-phosphates, an Aldotriose, glyceraldehyde3 phosphate and a Ketotriose, Dihydroxy acetone phosphate.

Note

- The reaction is reversible
- There is neither expenditure of energy nor formation ATP
- Aldolases are tetramers, containing 4 subunits. Two isoenzymes. A, B
Aldolase B: occurs in liver and kidney
- The fructose- 6-p exists in the cells in “furanose” form but they react with isomerase, phosphofructokinase-1 and aldolase in the open-chain configuration.
- Both triose phosphates are interconvertible

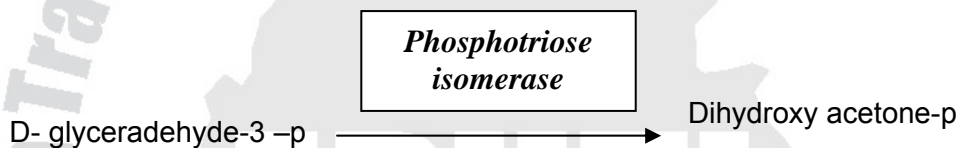

Stage III

This is the energy- yielding reaction. Reactions of this type in which an aldehyde group is oxidized to an acid are accompanied by liberation of large amounts of potentially useful energy.

This stage consists of the following two reactions:

1. Oxidation of Glyceraldehyde 3phosphate to 1,3 bis phosphoglycerate

Glycolysis proceeds by the oxidation of glyceraldehde-3-phosphate, to form 1,3-bis phosphoglycerate.

Dihydroxyacetone phosphate also forms 1, 3 - bisphosphoglycerate via glyceraldehydes-3-phosphate shuttle. The enzyme responsible is Glyceraldehyde 3 phosphate dehydrogenase, which is NAD⁺ dependant.

Energetics

1. In first reaction of this stage- NADH produced will be oxidized in electron transport chain to produce 3 ATP in presence of O₂. Since two molecules of triose phosphate are formed per molecule of glucose oxidized, 2 NADH will produce 6 ATP.

+6ATP

2. The second reaction will produce one ATP. Two molecules of substrate will produce ATP.

+2ATP

Net gain at this stage per molecule of glucose oxidized= + 8ATP

Stage IV

This is the recovery of the PO_4 group from 3-phosphoglycerate. The two molecules of 3-phosphoglycerate, the end-product of the previous stage, still retain the PO_4 group originally derived from ATP in stage 1. The body wants to recover the two ATP spent in the first stage for two phosphorylation reactions. This is achieved by following three reactions:

1. Conversion of 3-phosphoglycerate to 2-Phosphoglycerate

3-Phosphoglycerate formed by the above reaction is converted to 2-phosphoglycerate, catalyzed by the enzyme phosphoglycerate mutase. It is likely that 2,3-bisphosphoglycerate is an intermediate in the reaction and probably acts catalytically.

2. Conversion of 2-phosphoglycerate to Phosphoenol pyruvate

The reaction is catalyzed by the enzyme enolase, the enzyme requires the presence of either Mg^{++} or Mn^{++} for activity. The reaction involves dehydration and redistribution of energy within the molecule raising the PO_4 in position 2 to a "high-energy state".

3. Conversion of phosphoenol pyruvate to pyruvate

Phosphoenol pyruvate is converted to 'Enol' pyruvate, the reaction is catalyzed by the enzyme pyruvate kinase. The high energy PO_4 of phosphoenol pyruvate is directly transferred to ADP producing ATP.

Note

- Reaction is irreversible
- ATP is formed at the substrate level without electron transport chain. This is another example of "substrate level phosphorylation" in glycolytic pathway
- "Enol" pyruvate is converted to 'Keto' pyruvate spontaneously.
- But, cells having limited coenzymes, to continue the glycolytic cycle NADH must be oxidized to NAD^+ . This is achieved by re-oxidation of NADH by conversion of pyruvate to lactate (without producing ATP).

Significance of lactate formation:

Under anaerobic conditions NADH is re oxidized via lactate formation. This allows glycolysis to proceed in the absence of oxygen. The process generates enough NAD for another cycle of glycolysis.

B. Clinical Importance

- Tissues that function under hypoxic conditions will produce lactic acid from glucose oxidation. Produces local acidosis. If lactate production is more it can produce metabolic acidosis
- Vigorously contracting skeletal muscle will produce lactic acid.
- Whether O₂ is present or not, glycolysis in erythrocytes always terminated in to pyruvate and lactate.

Entry of fructose in to glycolysis:

Liver contains specific enzymes fructokinase. It converts fructose to fructose 1 phosphate in the presence of ATP. In liver fructose1-phosphate is split to glyceraldehyde and dihydroxy acetone phosphate by AldolaseB.

Glyceraldehyde enters glycolysis, when it is phosphorylated to glyceraldehyde-3-P by triose kinase.

Dihydroxy aceton phosphate and glyceraldehyde-3-P may be degraded via glycolysis or may be condensed to form glucose by aldolase.

Lack of fructose kinase leads to fructosuria. Absence of aldolaseB leads to hereditary fructose intolerance. If fructose 1, 6 bisphosphatase is absent, causes fructose induced hypoglycemia.

The reason being high concentration of Fructose 1 phosphate and fructose 1, 6 bis phosphate inhibit Liver phosphorylase by allosteric modulation.

As in case of Galactose, fructose intolerance can also lead to cataract formation.

Galactose:

Milk sugar contains galactose. Galactokinase converts galatose to galactose-1-P. It reacts with UDP-glucose to form UDP-galactose and glucose-1-P. The enzyme is Galactose-1-P uridyltransferase. UDP-galactose can be epimerized to UDP-glucose by 4-epimerase. Glycogenesis also requires UDP-glucose. UDP-galactose can be condensed with glucose to form lactose.

Galactosemia:

Some people cannot metabolize galactose. It is an inherited disorder that the defect may be in the galactokinase, uridyl transferase or 4-epimerase. Most common is uridyl transferase. Such patients have high concentration of Galactose in blood (Galactosemia). In lens, Galactose is reduced to galactitol by aldose reductase. The product accumulates in lens and leads to accumulation of water by osmotic pull. This leads to turbidity of lens proteins (Cataract).

If uridyl transferase was absent galactose 1-phosphate accumulates. Liver is depleted of inorganic phosphate. This ultimately causes failure of liver function and mental retardation.

If 4-epimerase is absent, since the patient can form UDP-galactose from glucose the patient remains symptom free.

Glycogen metabolism

Introduction

Glycogen is the major storage form of carbohydrate in animals. It is mainly stored in liver and muscles and is mobilized as glucose whenever body tissues require.

Degradation of Glycogen (glycogenolysis)

A. Shortening of chains

Glycogen phosphorylase cleaves the α -1, 4 glycosidic bonds between the glucose residues at the non reducing ends of the glycogen by simple phosphorolysis.

- This enzyme contains a molecule of covalently bound pyridoxal phosphate required as a coenzyme,
- Glycogen phosphorylase is a phosphotransferase that sequentially degrades the glycogen chains at their non reducing ends until four glucose units remain on each chain before a branch point. The resulting structure is called a limit dextrin and phosphorylase cannot degrade it any further. The product of this reaction is Glucose 1 phosphate.
- The glucose 1 phosphate is then converted to glucose 6 phosphate by phosphoglucomutase.
- Conversion of glucose 6 phosphate to glucose occurs in the Liver, Kidney and intestines by the action of Glucose 6 phosphatase. This does not occur in the skeletal muscle as it lacks the Enzyme.

B. Removal of Branches

A debranching enzyme also called Glucantransferase which contains two activities, Glucantransferase and Glucosidase. The transfer activity removes the terminal 3 glucose residues of one branch and attaches them to a free C₄ end of the second branch. The glucose in α -(1,6) linkage at the branch is removed by the action of Glucosidase as free glucose.

C. Lysosomal Degradation of Glycogen

A small amount of glycogen is continuously degraded by the lysosomal enzyme α -(1, 4) glycosidase (acid maltase). The purpose of this pathway is unknown. However, a deficiency of this enzyme causes accumulation of glycogen in vacuoles in the cytosol, resulting in a very serious glycogen storage disease called type II (Pomp's disease),



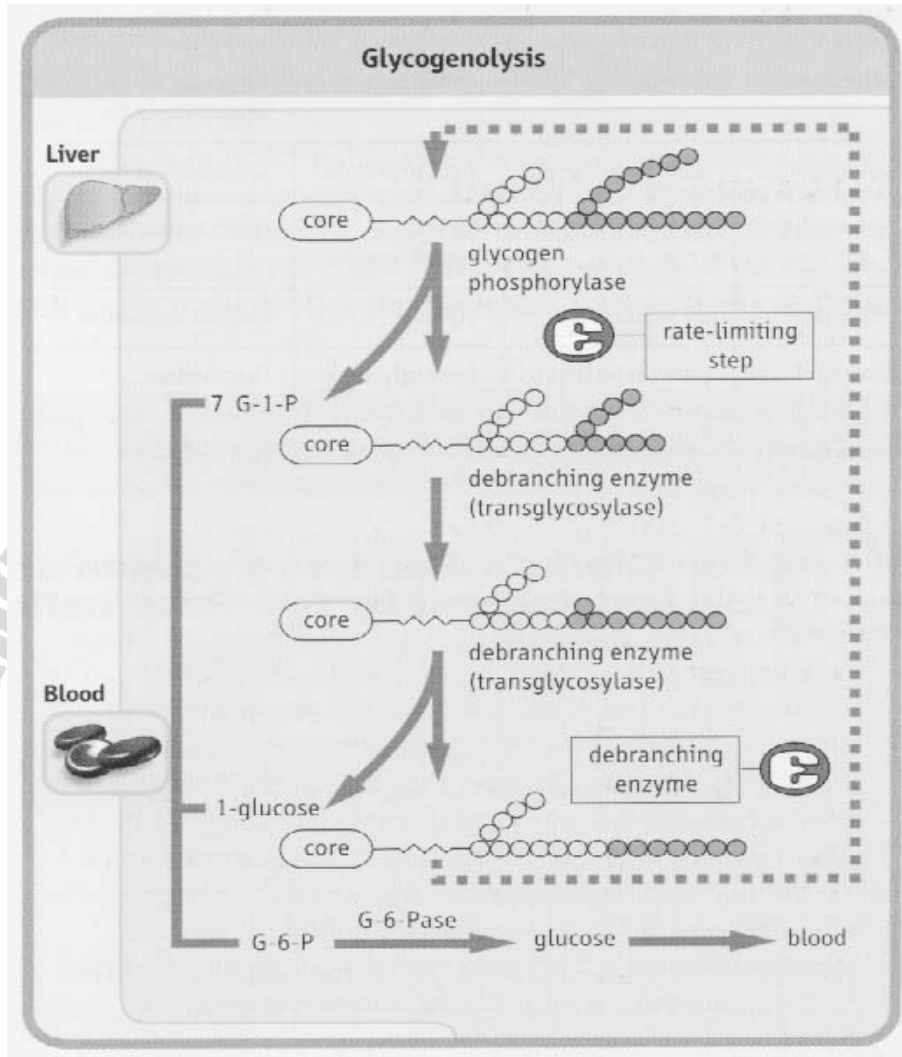

Fig.2.9 Summary of Glycogenolysis

Synthesis of Glycogen (Glycogenesis)

Synthesis of glycogen from Glucose is carried out by the enzyme Glycogen Synthase. The activation of glucose to be used for glycogen synthesis is carried out by the enzyme UDP-glucose pyrophosphorylase. The enzyme exchanges the phosphate on C-1 of glucose-1-phosphate for UDP (Uridinediphosphate). The energy of the phospho glycosyl bond of UDP-glucose is utilized by glycogen Synthase to catalyze the incorporation of glucose in to Glycogen. UDP is subsequently released from the enzyme. The α -1,6 branches in glucose are produced by amylo-(1,4-1,6) transglycosylase, also termed as branching enzyme. This enzyme transfers a terminal fragment of 6 to 7 glucose residues (from a polymer of at least 11 glucose residues long) to an internal glucose residue at the C-6 hydroxyl position.

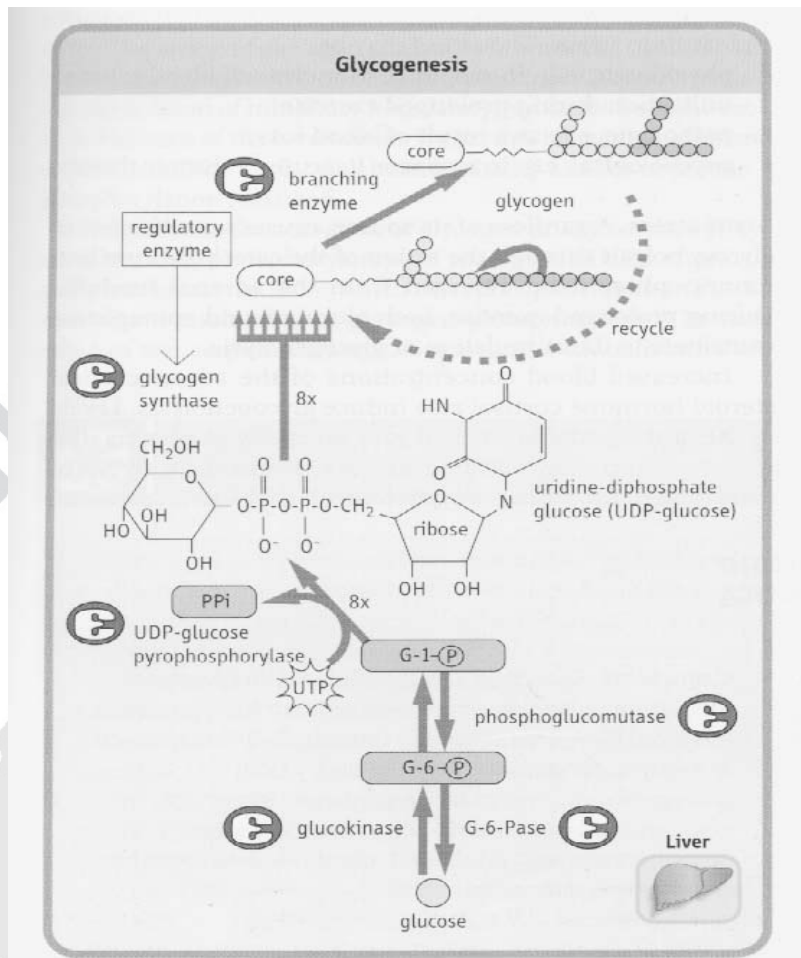

Fig 2.10. Glycogenesis

Glycogen storage diseases

These are a group of genetic diseases that result from a defect in an enzyme required for either glycogen synthesis or degradation. They result in either formation of glycogen that has an abnormal structure or the accumulation of excessive amounts of normal glycogen in specific tissues,

A particular enzyme may be defective in a single tissue such as the liver or the defect may be more generalized, affecting muscle, kidney, intestine and myocardium. The severity of the diseases may range from fatal in infancy to mild disorders that are not life threatening some of the more prevalent glycogen storage diseases are the following.

Table of Glycogen Storage Diseases

Type: Name	Enzyme Affected	Primary Organ	Manifestations
Type 0	glycogen synthase	liver	Hypoglycemia and early death,
Type Ia: von Gierke's	glucose-6-phosphatase	liver	hepatomegaly, kidney failure, fatty liver, hyperlacticacidimia and severe hypoglycemia
Type II: Pompe's	lysosomal α -1,4-glucosidase, lysosomal acid α -glucosidase acid maltase	skeletal and cardiac muscle	muscular dystrophy, severe cardiomegaly, early death.
Type V: McArdle's	muscle phosphorylase	skeletal muscle	Muscle exercise-induced cramps and pain, myoglobinuria

The Pentose Phosphate Pathway

The pentose phosphate pathway is primarily an anabolic pathway that utilizes the 6 carbons of glucose to generate 5 carbon sugars and reducing equivalents. However, this pathway does oxidize glucose and under certain conditions can completely oxidize glucose to CO₂ and water. The primary functions of this pathway are:

To generate reducing equivalents, in the form of NADPH, for reductive biosynthesis reactions within cells.

To provide the cell with ribose-5-phosphate (R5P) for the synthesis of the nucleotides and nucleic acids.

Although not a significant function of the PPP, it can operate to metabolize dietary pentose sugars derived from the digestion of nucleic acids as well as to rearrange the carbon skeletons of dietary carbohydrates into glycolytic/gluconeogenic intermediates

Enzymes that function primarily in the reductive direction utilize the NADP⁺/NADPH cofactor pair as co-factors as opposed to oxidative enzymes that utilize the NAD⁺/NADH cofactor pair. The reactions of fatty acid and steroid biosynthesis utilize large amounts of NADPH. As a consequence, cells of the **liver**, **adipose tissue**, **adrenal cortex**, **testis** and **lactating mammary gland** have high levels of the PPP enzymes. In fact 30% of the oxidation of glucose in the liver occurs via the PPP. Additionally, **erythrocytes** utilize the reactions of the PPP to generate large amounts of NADPH used in the reduction of glutathione. The conversion of ribonucleotides to deoxyribonucleotides (through the action of **ribonucleotide reductase**)

requires NADPH as the electron source, therefore, any rapidly proliferating cell needs large quantities of NADPH.

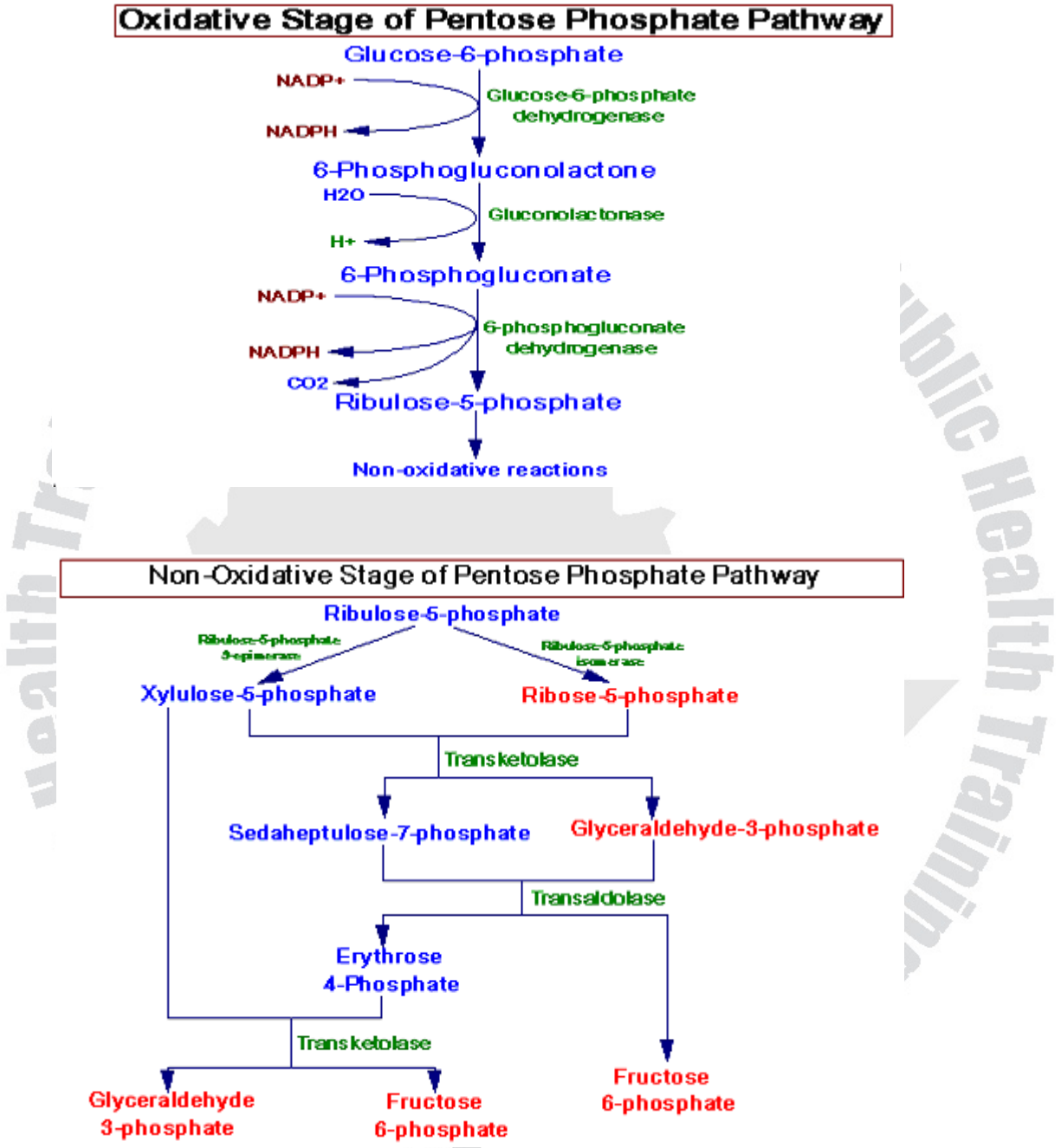

Fig 2.11 Oxidative and non –oxidative phases of HMP shunt

Significance of HMP shunt

The net result of the PPP, if not used solely for R5P production, is the oxidation of G6P, a 6 carbon sugar, into a 5 carbon sugar. In turn, 3 moles of 5 carbon sugar are converted, via the

enzymes of the PPP, back into two moles of 6 carbon sugars and one mole of 3 carbon sugar. The 6 carbon sugars can be recycled into the pathway in the form of G6P, generating more NADPH. The 3 carbon sugar generated is glyceraldehyde-3-phosphate which can be shunted to glycolysis and oxidized to pyruvate. Alternatively, it can be utilized by the gluconeogenic enzymes to generate more 6 carbon sugars (fructose-6-phosphate or glucose-6-phosphate).

Glutathione is the tripeptide **γ -glutamylcysteinylglycine**. The cysteine thiol plays the role in reducing oxidized thiols in other proteins. Oxidation of 2 cysteine thiols forms a disulfide bond. Although this bond plays a very important role in protein structure and function, inappropriately introduced disulfides can be detrimental. Glutathione can reduce disulfides nonenzymatically. Oxidative stress also generates peroxides that in turn can be reduced by glutathione to generate water and an alcohol. It can also reduce hydrogen per-oxide in to two molecules of water.

Regeneration of reduced glutathione is carried out by the enzyme, **glutathione reductase**. This enzyme requires the co-factor NADPH when operating in the direction of glutathione reduction which is the thermodynamically favored direction of the reaction.

It should be clear that any disruption in the level of NADPH may have a profound effect upon a cells ability to deal with oxidative stress. No other cell than the erythrocyte is exposed to greater oxidizing conditions. After all it is the oxygen carrier of the body.

The PPP in erythrocytes is essentially the only pathway for these cells to produce NADPH. Any defect in the production of NADPH could, therefore, have profound effects on erythrocyte survival.

Several deficiencies in the level of activity (not function) of **glucose-6-phosphate dehydrogenase** have been observed to be associated with resistance to the malarial parasite, *Plasmodium falciparum*, among individuals of Mediterranean and African descent. The basis for this resistance is the weakening of the red cell membrane (the erythrocyte is the host cell for the parasite) such that it cannot sustain the parasitic life cycle long enough for productive growth.

Coris Cycle or Lactic Acid Cycle

In an actively contracting muscle, only about 8% of the pyruvate is utilized by the citric acid cycle and the remaining is, therefore, reduced to lactate. The lactic acid thus generated should not be allowed to accumulate in the muscle tissues. The muscle cramps, often associated with strenuous muscular exercise are thought to be due to lactate accumulation. This lactate diffuses into the blood. During exercise, blood lactate level increases considerably. Lactate then reaches

liver where it is oxidized to pyruvate. It is then taken up through gluconeogenesis pathway and becomes glucose, which can enter into blood and then taken to muscle. This cycle is called cori's cycle, by which the lactate is efficiently reutilized by the body.

Significance of the cycle:

Muscle cannot form glucose by gluconeogenesis process because glucose 6 phosphatase is absent. Unlike Liver, muscle cannot supply Glucose to other organs inspite of having Glycogen.

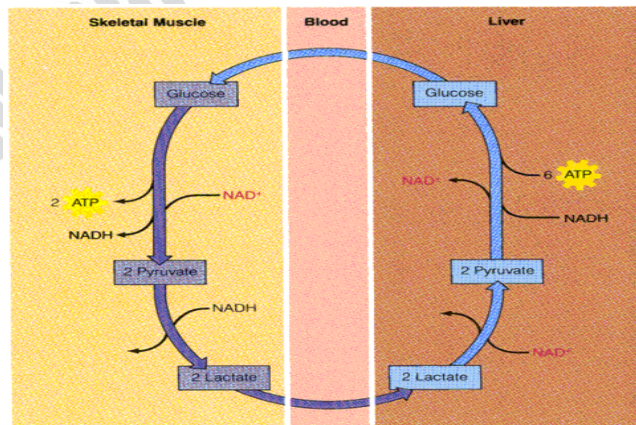

Fig 2.12 The Cori cycle.

Gluconeogenesis

Gluconoegensis is the biosynthesis of new glucose from non carbohydrate substrates.

In the absence of dietary intake of carbohydrate liver glycogen can meet these needs for only 10 to 18 hours

During prolonged fast hepatic glycogen stores are depleted and glucose is formed from precursors such as lactate, pyruvate, glycerol and keto acids.

Approximately 90% of gluconeogenesis occurs in the liver whereas kidneys provide 10 % of newly synthesized glucose molecules,

The kidneys thus play a minor role except during prolonged starvation when they become major glucose producing organs.

Reactions Unique to Gluconeogenesis

Seven of the reactions of glycolysis are reversible and are used in the synthesis of glucose from lactate or pyruvate. However three of the reactions are irreversible and must be bypassed by four alternate reactions that energetically favor the synthesis of glucose.

A. Carboxylation of Pyruvate

In gluconeogenesis, pyruvate is first carboxylated by pyruvate Carboxylase to oxaloacetate (OAA).where it is converted to Phosphoenolpyruvate (PEP) by the action of PEP carboxykinase,

Note: pyruvate carboxylase is found in the mitochondria of liver and kidneys, but not in muscle

1. Biotin is a coenzyme of pyruvate carboxylase derived from vitamin B6 covalently bound to the apoenzyme through an ϵ -amino group of lysine forming the active enzyme.
2. Allosteric regulation

Pyruvate carboxylase is allosterically activated by acetyl CoA. Elevated levels of acetyl CoA may signal one of several metabolic states in which the increased synthesis of oxaloacetate is required. For example, this may occur during starvation where OAA is used for the synthesis of glucose by gluconeogenesis,

At low levels of acetyl COA, pyruvate carboxylase is largely inactive and pyruvate is primarily oxidized in the TCA cycle

B. transport of Oxaloacetate to the Cytosol

Oxaloacetate, formed in mitochondria, must enter the cytosol where the other enzymes of gluconeogenesis are located. However, oxaloacetate is unable to cross the inner mitochondrial membrane directly. It must first be reduced to malate which can then be transported from the mitochondria to the cytosol. In the cytosol, Malate is reoxidized to oxaloactate (see figure 2.13)

C. Decarboxylation of Cytosolic Oxaloacetate.

Oxaloacetate is decarboxylated and phosphorylated in the cytosol by PEP-carboxykinase. The reaction is driven by hydrolysis of GTP

The combined action of pyruvate carboxylase and PEP carboxykinase provides an energetically favorable pathway from pyruvate to PEP.

PEP then enters the reversed reactions of glycolysis until it forms fructose 1, 6- bisphosphate. (see figure 2.13)

D. Dephosphorylation of fructose 1, 6 bisphosphate

Hydrolysis of fructose 1, 6-bisphosphate by fructose 1, 6-bisphosphatase passes the irreversible PFK- 1 reaction and provides energetically favorable pathway for the formation of fructose 6-phosphate.

This reaction is an important regulatory site of gluconeogenesis,

1. Regulation by energy levels within the cell:

Fructose 1, 6 bisphatase is inhibited by elevated levels of AMP, which signal an energy poor state in the cell

Conversely high levels of ATP and low concentrations of AMP stimulate gluconeogenesis

2. Regulation by fructose 2,6- bisphosphate

Fructose 1, 6-bisphosphatase is inhibited by fructose 2, 6-bisphosphate, an allosteric modifier whose concentration is influenced by the level of circulating glucagons. Fructose 1, 6 bisphosphatase occurs in liver and kidney

E. Dephosphorylation of glucose 6.phosphate

Hydrolysis of glucose 6-phosphate by glucose 6-phosphatase bypasses the irreversible hexokinase reaction provides energetically favorable pathway for the formation of free glucose,

Glucose 6-phosphatase like pyruvate carboxylase, occurs in liver and kidney, but not in muscle. Thus muscle cannot provide blood glucose from muscle glycogen.

C. F. Substrates for Gluconeogenesis

Gluconeogenic precursors are molecules that can give rise to a net synthesis of glucose. They include all the intermediates of glycolysis and the citric acid cycle.

Glycerol, lactate, and the α -keto acids obtained from the deamination of glucogenic amino acids are the most important gluconeogenic precursors.

A. Gluconeogenic Precursors

1. Glycerol is released during hydrolysis of triacylglycerol in adipose tissue and is delivered to the liver. Glycerol is phosphorylated to glycerophosphate an intermediate of glycolysis.
2. Lactate is released in the blood by cells, lacking mitochondria such as red blood cells, and exercising skeletal muscle.

B. Ketogenic compounds

AcetylCoA and compounds that give rise to acetyl CoA (for example acetocetate and ketogenic amino acids) cannot give rise to a net synthesis of glucose, this is due to the irreversible nature of the pyruvate dehydrogenase reaction, (pyruvate to acetyl CoA.) These compounds give rise to ketone bodies and are therefore termed Ketogenic.

Advantages of Gluconeogenesis

- 1) Gluconeogenesis meets the requirements of glucose in the body when carbohydrates are not available in sufficient amounts.
- 2) Regulate Blood glucose level
- 3) Source of energy for Nervous tissue and Erythrocytes
- 4) Maintains level of intermediates of TCA cycle
- 5) Clear the products of metabolism of other tissues(Muscle)

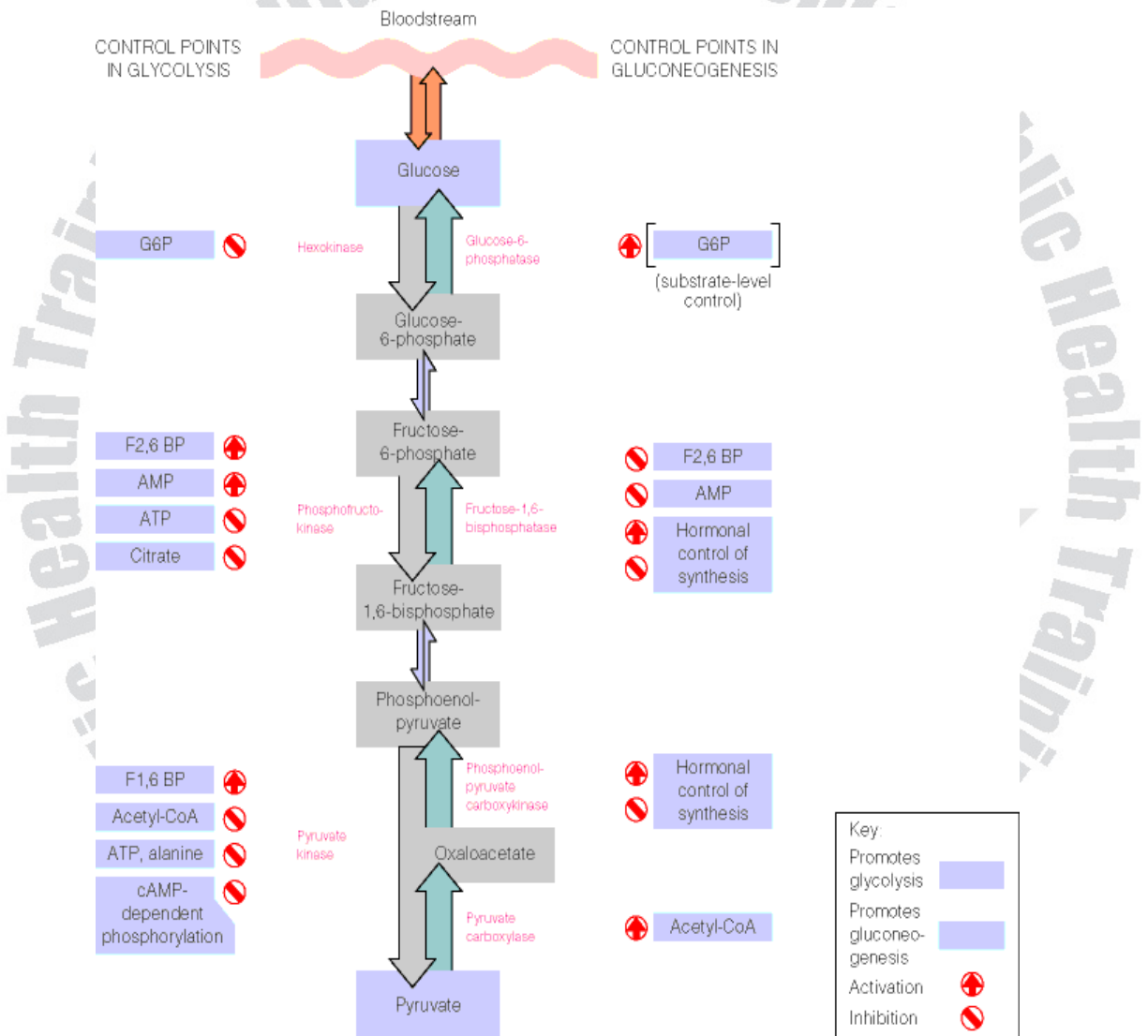
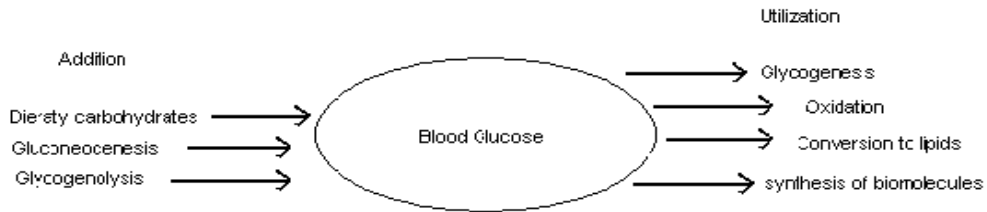

Fig.2.13 Major control mechanisms affecting glycolysis and gluconeogenesis

Homeostasis of Blood Glucose

Homeostasis of glucose is due to balance of addition and utilization of glucose. Fasting blood glucose is maintained between 80-120mg %. After a meal it rises by 40-60mg% and returns to normal within 2-3hours.



UNIT THREE

INTEGRATIVE METABOLISM AND BIOENERGETICS

Objectives

1. To enable the students:
2. Identify energy rich dietary constituents
3. Identify cellular sites of energy generation
4. Understand mechanism of cellular ATP formation and utilization
5. Understand ways of regulation of cellular energy metabolism
6. Understand the mechanism and effect of poisons on cellular energy generation

Energy Generation and Utilization in the Living System

I-Introduction

Energy is vital to life. Growth, reproduction and tissue repair require energy. Most organisms obtain energy by oxidation of these fuel molecules Carbohydrates, fats and amino acids. Cellular oxidation of these molecules release energy, part of which is conserved through the synthesis of high-energy phosphate bonds and the rest is lost as heat. The high-energy phosphate bonds are directly utilized for cellular energy requiring processes. ATP (adenosine triphosphate) is the common high-energy phosphate bond that is formed during oxidative processes.

Under cellular conditions energy releasing (oxidative) processes are coupled to energy requiring cellular processes through common energy currency, ATP.

It is the universal transfer agent of chemical energy between energy-yielding and energy-requiring cellular processes. Other high energy triphosphates include GTP, UTP, and CTP which are commonly used in biosynthesis (contain comparable energy to that of ATP).

ATP and other nucleotides of comparable energy, carry two high-energy phosphate bonds. The hydrolysis of these high - energy phosphate bonds release energy which powers cellular energy requiring processes. Thioester bonds also contain comparable energy content to that of ATP. Energy of hydrolysis of thioester bond is mostly used to drive the reactions forward to completion.

II- High-energy phosphate bonds

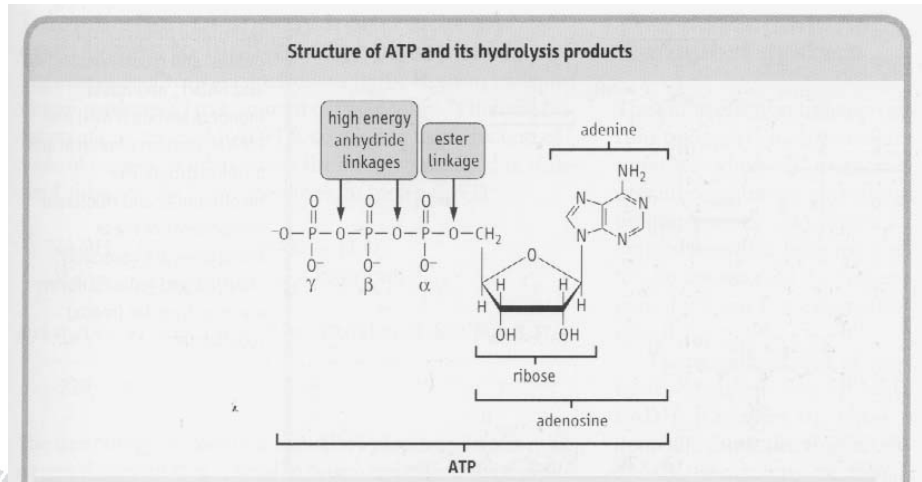

Fig 3.1 Structure of ATP

a) High-energy phosphate bonds:

- At pH 7, ATP⁻ carries four negative charges
- Charges repel each other because of proximity
- Repulsion is relieved upon hydrolysis of high-energy bonds

ATP and other high energy compounds contain phosphoanhydride bonds which release much free energy upon hydrolysis

b) Energy of hydrolysis of phosphate bonds

hydrolysis of high-energy phosphate bond of ATP releases free energy of

about -7.3 kcal/mol

energy released upon hydrolysis of high energy phosphate bonds may result in:-

transfer of phosphate group with partial conservation of energy by newly formed bond

formation of new bond

change in conformation of molecules

signal amplification

transport molecules across membranes

some portion lost as heat (may contribute to body temperature maintenance in homoeothermic organisms)

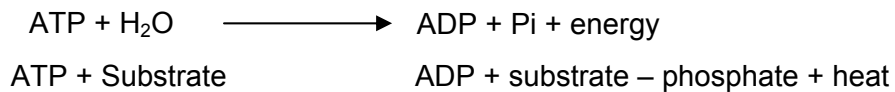

Hydrolysis of ATP or other nucleotides usually involves the terminal high-energy phosphate bond. Similarly, phosphate transfer involves the terminal phosphate group. The phosphate transfer also commonly involves the two terminal phosphate groups as pyrophosphate. Transfer of AMP portion of ATP is also common with concomitant hydrolysis of pyrophosphate (energy of hydrolysis driving the reaction forward)

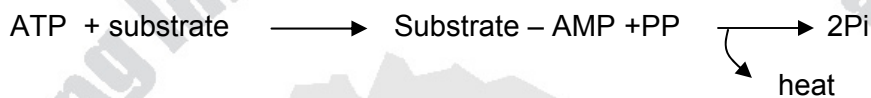

C-Cellular formation and utilization of ATP

Within cells ATP is continuously formed and utilized

Serve as the principal immediate donor of free energy in biological system

* oxidation of fuel molecules

Catabolism of fuel molecules occurs stepwise each step releasing partial energy content of molecules. The amount of total energy release depends upon the cellular conditions:

i-presence or absence of oxygen (aerobic or anaerobic)

ii-presence or absence of specific organelles with oxidative functions (mitochondrial)

Catabolic reactions in addition, provide building blocks for biosynthetic reactions

III- Catabolism of Fuel Molecules –An overview

a) Carbohydrates-digestion or mobilization of glycogen

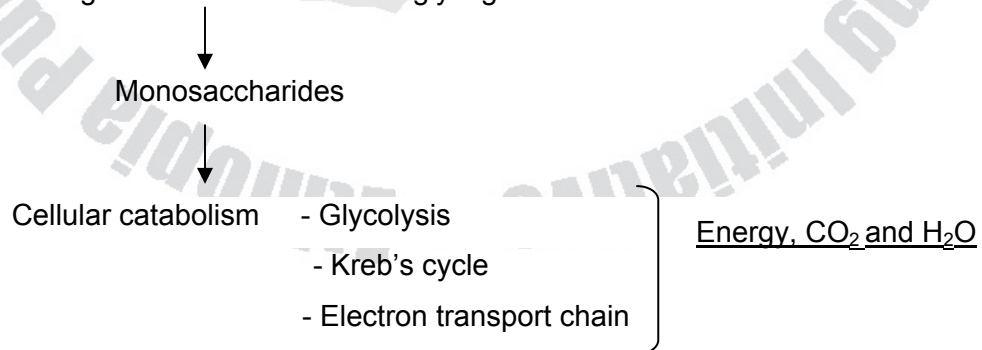

Exception– RBC (red blood cells)

Only glycolysis

Glycolysis- partial catabolism

- small amount of energy conserved (ATP, NADH)
- prepares carbohydrates for the next catabolic processes
- sometimes the only life sustaining energy generating process
 - RBC (red blood cells-lack mitochondrion)
 - exercising muscle (oxygen limitation)

b) Fats-digestion or mobilization of stored fat

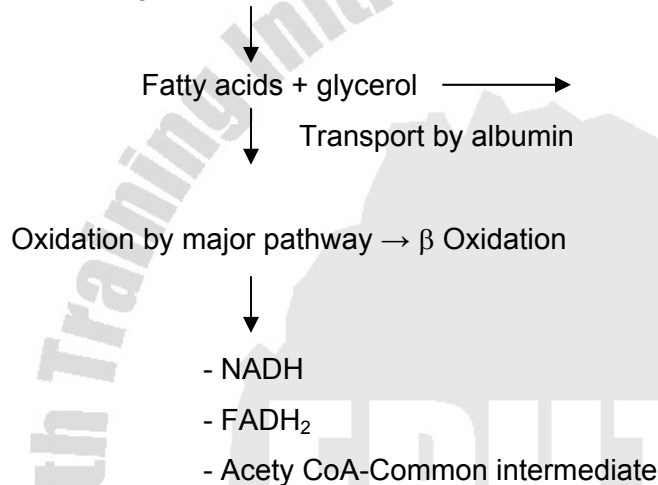

No direct high-energy phosphate molecule is formed

c) Proteins-digestion or mobilization of tissue protein

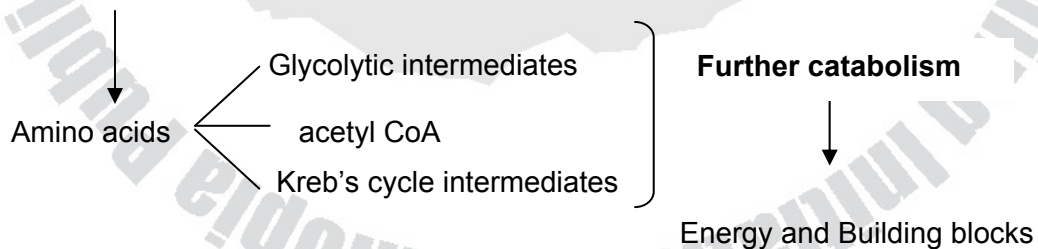

During cellular oxidation of fuel molecules very little energy is directly conserved in the form of high energy phosphate bond that can be directly utilized for cellular energy requiring processes. Most of it is captured in the form of reducing equivalents such as NADH (reduced nicotinamide adenosine dinucleotide) and FADH₂ (reduced flavin adenosine dinucleotide).

Section B- Concept of Free Energy

Definition – Free energy is that portion of the energy of a system available to do work as the system proceeds toward equilibrium under conditions of constant temperature and pressure and volume

The change in free energy content (ΔG) depends on two components

ΔH (change in enthalpy, internal energy heat) and ΔS (change in entropy)

$$\Delta G = \Delta H - T\Delta S$$

Chemical reaction performs work if it can be harnessed in utilizable form of energy. Amount of work performed depends on the efficiency of the machinery.

Free energy change of a biological reactions is reported as the standard free energy change (ΔG^0)

ΔG^0 is the value of ΔG for a reaction at standard conditions for biological reactions (pH 7, 1M, 25°C, 1 atmosphere pressure)

Free energy change is used to predict the direction and equilibrium of chemical reactions

If ΔG is negative – net loss of energy (exergonic)

- reaction goes spontaneously

If ΔG is positive - net gain of energy (endergonic)

reaction does not go spontaneously

If ΔG is zero- reactants are in equilibrium

C - Oxidation-Reduction Reactions

The utilization of chemical energy in living system involves oxidation – reduction reactions. For example, the energy of chemical bonds of carbohydrates, lipids and proteins is released and captured in utilization form by processes involving oxidation- reductions.

I- Oxidation - removal of electron(s) from substance

- usually accompanied by a decrease in energy content of oxidized substance

II-Reduction - addition of electron(s) to a substance

usually accompanied by an increase in energy content of reduced substance

Oxidation reduction reactions are coupled processes

Example: $\text{H}_2 \longrightarrow 2\text{e}^- + 2\text{H}^+$ – first half reaction
 – oxidation of H_2
 – release electrons and protons
 – requires second half reaction coupled to
 – oxidation of H_2

$\frac{1}{2} \text{O}_2 + 2\text{e}^- + 2\text{H}^+ \longrightarrow \text{H}_2\text{O}$ – second half reaction
 – reduction of O_2
 – oxidation of H_2 is coupled to reduction of O_2

III- Reduction Potential (Oxidation-reduction potential, E'_o)-Concept

Definition - Measure of electron donating tendencies

Electrically measured in reference to a standard substance H_2 . Determined by measuring the electromotive force generated by a sample half-cell with respect to standard reference half-cell

A negative E'_o = lower affinity for electrons

A positive E'_o = higher affinity for electrons



In this example, $2\text{H}^+/\text{H}_2$ redox pair has negative E'_o

- Electron donating tendency

where as $\frac{1}{2} \text{O}_2/\text{H}_2\text{O}$ redox pair has positive E'_o

- Electron accepting tendency

Hence, H_2 - electron donor (oxidized)

O_2 - electron acceptor (reduced)

Most molecules serve as both electron donors and electron acceptors of different times depending upon what other substances they react with. In biological systems the primary electron donors are fuel molecules such as carbohydrates, fats and proteins.

The oxidation of these substances transfers electrons to intermediate electron carriers such as NAD^+ , NADP^+ and FAD to reduce them to their reduced state NADH , and FADH_2 .

Reduction potential of the $\text{NAD}^+ / \text{NADH}$ pair is -0.32V , placed high on the electron tower, good electron donor and that of $\frac{1}{2} \text{O}_2/\text{H}_2\text{O}$ is $+0.82\text{V}$.

In respiratory chain the electrons from NADH are transferred through a series of carriers (organic or inorganic) until they are accepted by molecular oxygen (O₂) releasing energy at different levels. The free-energy change of an oxidation – reduction reaction can be calculated from the difference in reduction potentials of the reactants using the formula:

$$\Delta G^{\circ} = -nF\Delta E'_{\circ}$$

Where n = 2 (No of electrons transferred)

F = 23.06 faraday constant

$\Delta E'_{\circ} = +0.82 - (-0.32) = 1.14$ V potential difference

For example consider oxidation of NADH by O₂

$$\Delta G^{\circ} = -2 \times 23.06 \text{ kcal V}^{-1} \text{ mol}^{-1} \times 1.14 \text{ V}$$

$$= -52.6 \text{ Kcal/mol}$$

heat

3 ATP (about 40% of efficiency)

Under cellular condition part of the free-energy of oxidation of reducing equivalents is conserved in the form of high-energy phosphate compound, ATP. This occurs by the help of energy conserving system in the inner mitochondrial membrane of eukaryotes or plasma membrane of prokaryotes.

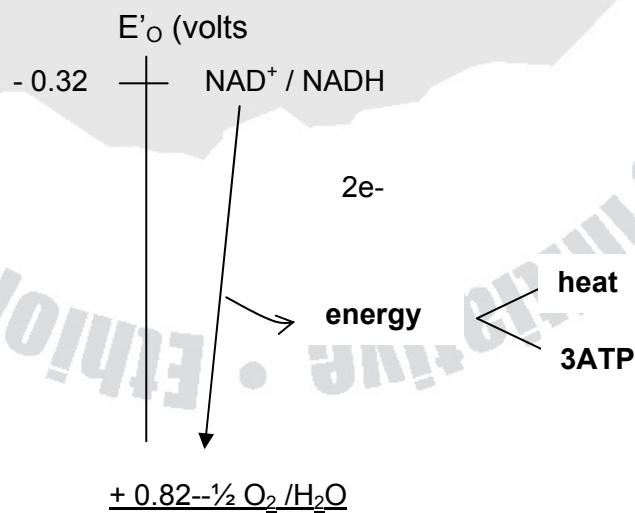

Fig 3.2. Change in free energy as a result of oxidation of NADH

Aerobic Energy-Generation

In aerobic organisms the complete breakdown of fuel molecules, carbohydrates, fats and proteins takes place in mitochondria of eukaryotes and cytoplasmic membrane and cytoplasm of aerobic prokaryotes.

The fuel molecules are metabolized to a common intermediate called acetyl CoA which is further degraded by a common pathway called Krebs's cycle.

This metabolic pathway in addition to providing energy provides building blocks required for growth, reproduction, repair and maintenance of cellular viability.

Mitochondria - it is an organelle where major amount of energy produced. Structurally it is bounded by two separate membranes (outer mitochondrial membrane and inner mitochondrial membrane)

Out membrane - smooth and unfolded
- Freely permeable to most ions and polar molecules
(Contain porous channels)

Inner membrane - folded into cristae-increased surface area
- Highly impermeable to most ions and polar molecules

Contain transporters which access polar and ionic molecules in and out

Cristae are characteristic of muscle and other metabolically active cell types

- Protein-rich membrane (about 75%)

Inter membrane space – space between outer and inner membranes

Matrix-the internal compartment containing soluble enzymes and mitochondrial genetic material

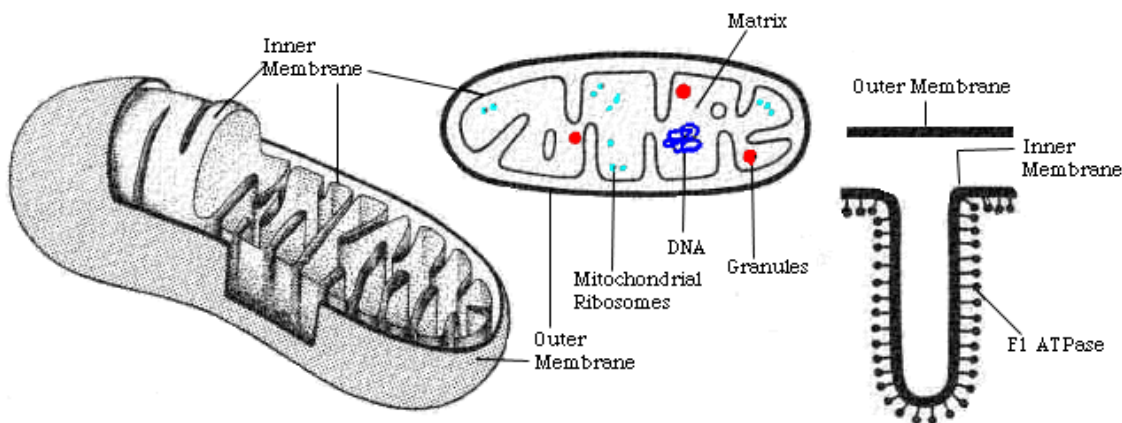

Fig 3.3 Structure of a mitochondria

Oxidation of Pyruvate

Pyruvate is common intermediate of many catabolic reactions. It is still energy rich molecule. It is a cross road molecule which can be converted into different intermediates depending on :- type of cells-eukaryotes except RBC- acetyl CoA

- aerobic prokaryotes- acetyl CoA
- anaerobic prokaryotes- ethanol or lactate
- in RBC-always lactate

absence or presence of oxygen -lactate, ethanol or acetyl-CoA

- high ratio of NADH/NAD⁺ favors lactate formation in actively exercising muscle (oxygen limitation)

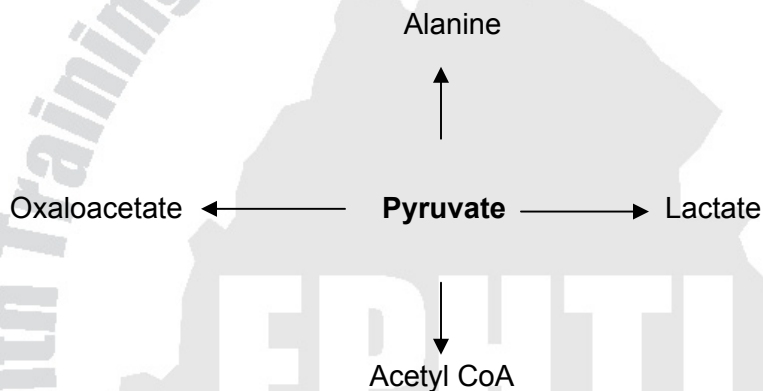

Oxidation of pyruvate into acetyl CoA-aerobic process (O₂ terminal electron-acceptor) which takes place in the mitochondrial matrix of eukaryotic cells Pyruvate is transported into mitochondrial matrix by special transporter. Inside matrix pyruvate is oxidized into acetylCoA by pyruvate dehydrogenase complex which is complex of E₁, E₂ and E₃ enzymes. This enzyme requires five coenzymes- TPP, Lipoate, CoA, FAD and NAD⁺

Where: E₁ = pyruvate dehydrogenase,
 E₂ = dihydrolipoyl transacetylase,
 E₃ = dihydrolipoyl dehydrogenase



Regulation of Pyruvate Dehydrogenase

Product Inhibition by - acetyl CoA

- elevated levels of NADH

Covalent modification - dephosphorylated (active) - Increased ADP/ATP ratio

- Phosphorylated (inactive) - increased acetyl CoA/CoA ratio

- Increased NADH/NAD⁺ ratio

KREB'S CYCLE

Also called-tricarboxylic acid cycle (TCA) or Citric acid cycle Final common pathway for complete oxidation of carbohydrates, fatty acids and many amino acids. Common pathway for catabolism of acetyl CoA ,a common intermediate of different catabolic pathways

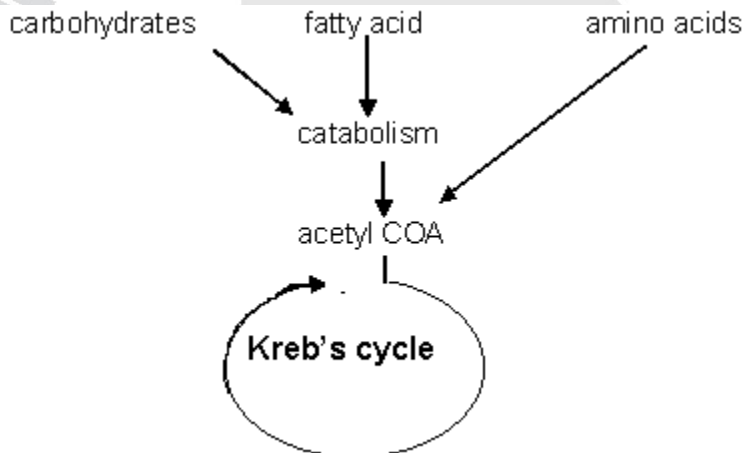

Aerobic process (occurs in aerobic cells in presence of oxygen (O₂)). Reactions take place in cytosol of prokaryotes and mitochondria matrix of eukaryotes

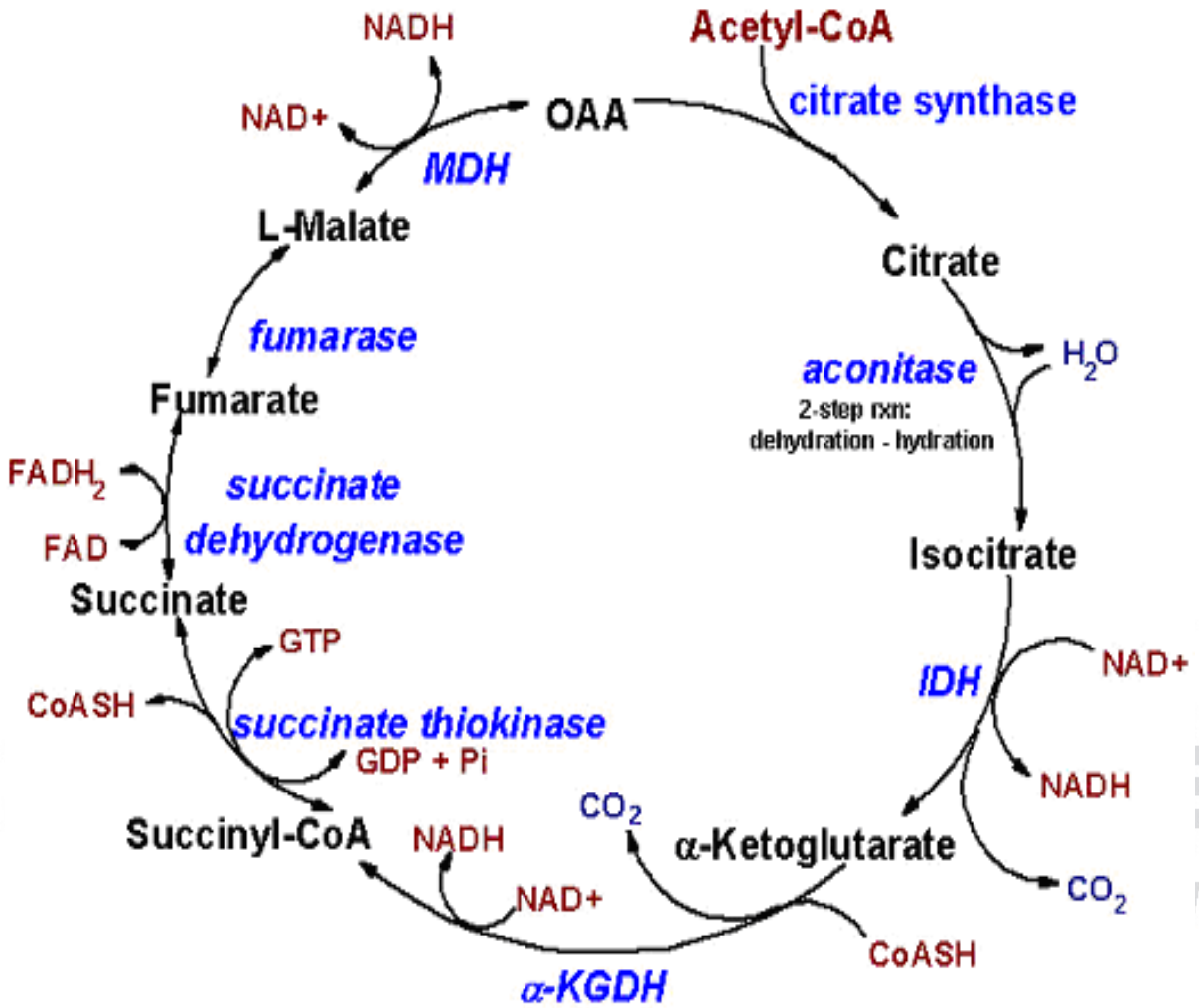
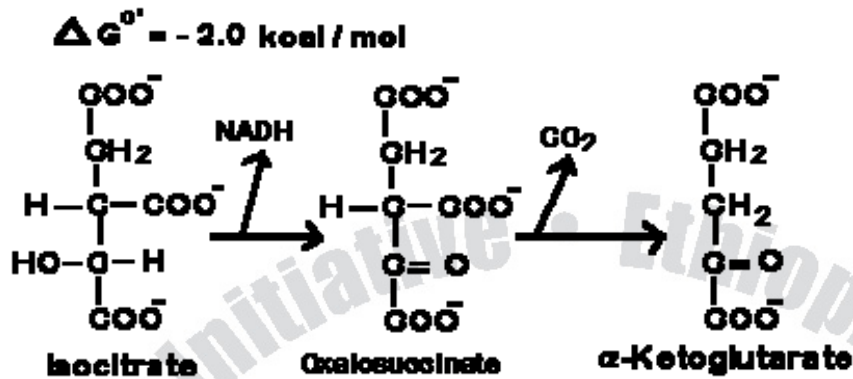

Fig 3.4 The citric acid cycle

Ethiopia Publishing Initiative

3. Oxidative decarboxylation of isocitrate by isocitrate dehydrogenase



There are three types of isocitrate dehydrogenases

NAD⁺ - specific – only mitochondrial

NADP⁺ - specific – cytosolic and mitochondrial

Respiratory chain linked oxidation of isocitrate proceeds almost completely through NAD⁺ - dependent enzyme

* Cytosolic isocitrate dehydrogenase reaction generates NADPH and CO₂
anabolic role

4. Oxidative decarboxylation of α - ketoglutarate by α - ketoglutarate dehydrogenase complex

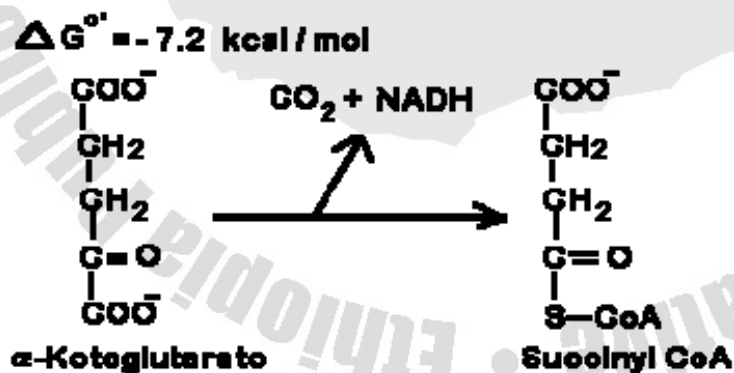

α -ketoglutarate is structurally and functionally similar to pyruvate dehydrogenase complex of three enzymes (A' B' C')

A' (α - ketoglutarate dehydrogenase), B' (transsuccinylase), C' (dihydrolipoyl dehydrogenase). This enzyme has the same coenzyme requirement to that of pyruvate dehydrogenase complex. The reaction releases considerable energy, part of which is used to form high-energy thioester bond and NADH. Arsenite inhibits α -Ketoglutarate dehydrogenase complex blocking Krebs' cycle. α -Ketoglutarate accumulates upon poisoning of the enzyme. Arsenite is also inhibitor of pyruvate dehydrogenase complex

5. Conversion of succinyl CoA into succinate by succinate thiokinase (succinyl CoA synthetase)

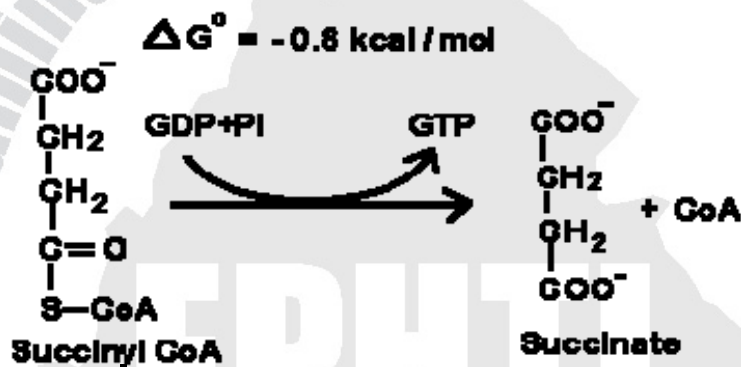

GTP is formed by substrate – level phosphorylation

Fates of GTP - participate in mitochondrial protein synthesis

Converted into ATP.

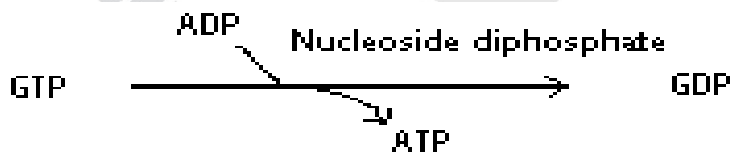

The ATP thus formed will be transported to the cytosol and used in ATP requiring reactions or converted to other triphosphate nucleotides.

6. Oxidation of succinate by succinate dehydrogenase

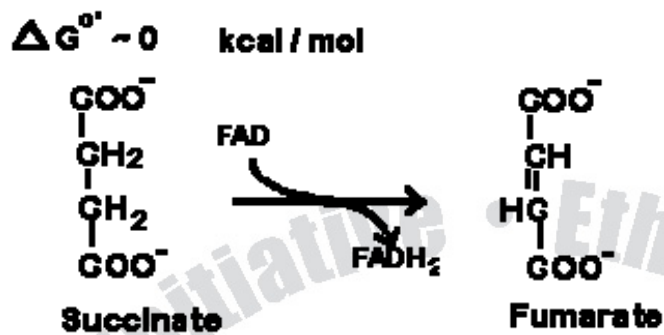

- Stereospecific for transfer of H-atoms of succinate (*)
- Succinate dehydrogenase – is integral part of inner mitochondrial membrane
- Contains Fe – S centers (non-heme iron protein) and FAD as prosthetic groups

Flavoprotein

- Inhibited by malonate which competes for the active site of the enzyme
-OOC-CH₂-COO- (Malonate)
- Also inhibited by oxaloacetate resulting in succinate accumulation.

7. Hydration of Fumarate by Fumarase

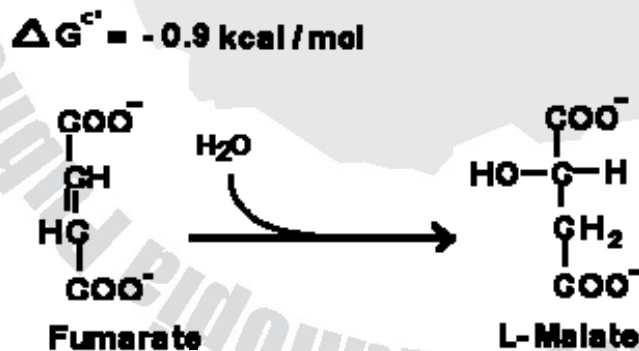

- Fumarase is stereospecific for L-malate (catalyzes stereospecific trans addition of H and OH).

8. Oxidation of L-malate by NAD-linked malate dehydrogenase

$$\Delta G^{\circ} = +7.1 \text{ kcal/mol}$$

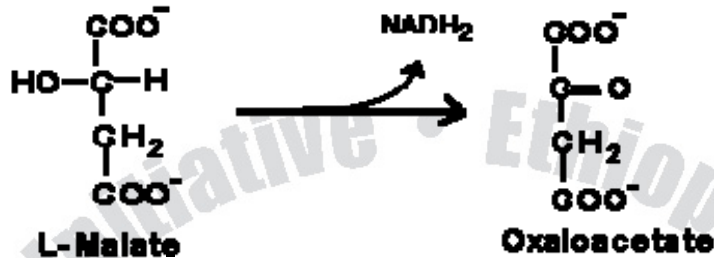

This reaction regenerates oxaloacetate, used in the first reaction.

N.B:

The cycle is aerobic process i.e. regeneration of oxidized coenzymes requires O₂ as terminal electron acceptor.

No net consumption or production of cycle intermediates

Oxaloacetate plays catalytic role in catabolism of acetyl CoA

Energy of acetyl CoA catabolism is partly conserved as reducing equivalents (NADH and FADH₂) and GTP

GTP is formed by substrate – level phosphorylation (synthesis of ATP related to oxidation of substrates not related to electron transport)

Net consumption of two molecules of H₂O

Enzymes – soluble and membrane attached (succinate dehydrogenase)

b-Functions of Krebs's Cycle

Krebs's cycle has catabolic and anabolic functions

Energy generation – reducing equivalents, NADH and FADH₂
– TP

Provide CO₂ used for – gluconeogenesis

- fatty acid synthesis
- urea synthesis
- nucleotide synthesis

Provide precursors for – gluconeogenesis (all intermediates)

- amino acid synthesis (non-essential amino acids)
- heme synthesis (succinyl CoA)
- fatty acid synthesis (citrate)

Regulate other pathways – citrate (inhibit phosphofructokinase)

pyruvate carboxylation with formation of oxaloacetate replenishes the cycle intermediates used for biosynthesis.

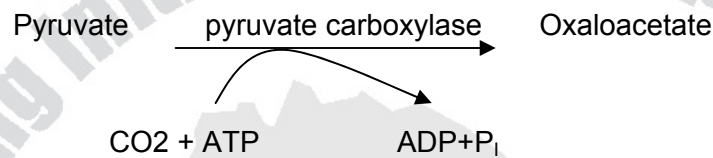

Note -different amino acids enter the cycle at different points

- Propionyl CoA (product of odd number fatty acid oxidation) enter the cycle as succinyl CoA

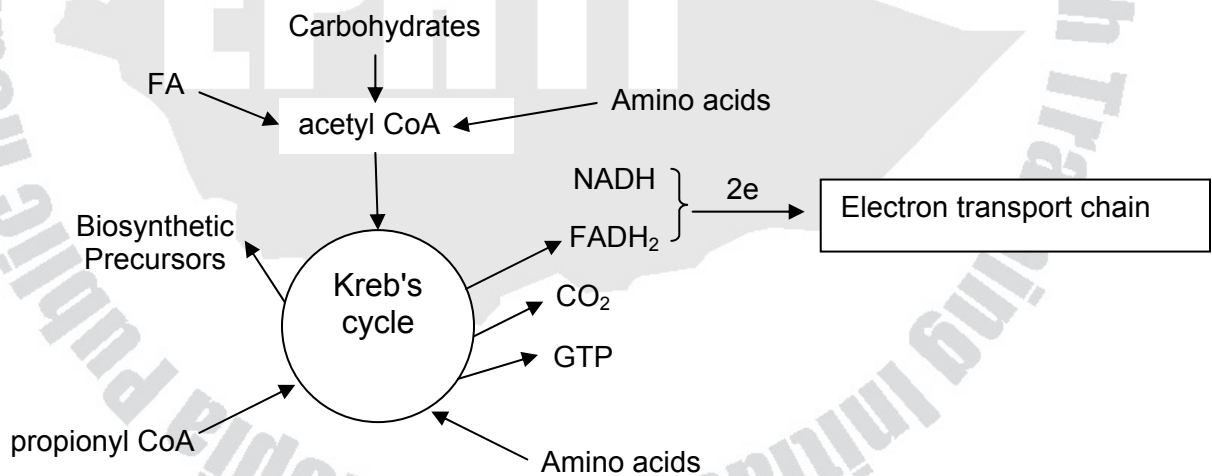

C - Regulation of Krebs's Cycle

Primary function of the cycle is to provide energy, thus rate of the cycle is adjusted to meet an animal cells ATP demand. Increased utilization of ATP increases the rate the cycle because of availability of oxidized coenzymes necessary for the continuation of the cycle (NAD⁺, FAD) and ADP which is needed for oxidative phosphorylation. High levels of ATP and NADH are inhibitory

indicating high energy status of the cell. ATP inhibits both citrate synthase and isocitrate dehydrogenase where as both are activated by high levels of ADP. NADH inhibits isocitrate dehydrogenase and α -Ketoglutarate dehydrogenase. Complementary mechanisms of controlling rate of acetyl CoA formation and rate of acetyl CoA degradation is also involved

III- Electron Transport system and Oxidative Phosphorylation

In aerobic organisms the major amount of ATP is synthesized by phosphorylation of ADP related to electron transport, a process occurring on the inner mitochondrial membrane of eukaryotes. It is a system composed of a chain of membrane associated electron carriers.

a- Components:

flavoproteins – FMN and FAD prosthetic groups. Accept H atoms but donate electrons
 nonheme iron-sulfur proteins (Fe: S centers). Carry electrons not H – atoms. They are component of complexes (I, II and III)

Coenzyme Q - Non protein component, Quinone derivative, lipid soluble. Common form in mammals is Q₁₀ Containing ten isoprene units. Accept H – atom but donate electrons. CoQ is mobile carrier of electrons between flavoproteins and cytochromes. Accept electrons from flavoproteins and donate to cytochromes. Transfer and accept two electrons at a time

Cytochromes – heme conjugated proteins

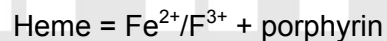

Include classes of cytochromes designated a, b, and c. Iron at the center of cytochromes accept and donates single electron



Cytochrome with relatively less positive reduction potential (i.e. cyt b) accepts electrons from CoQH₂ and transfers them to the next acceptor cytochrome with more positive reduction potential the electron carriers except for CoQ are prosthetic groups of proteins

Components of electron transport system are arranged according to the increasing order reduction potentials, a component with more negative reduction potential – at the top component with more positive reduction potential at the bottom. The components of respiratory chain are organized into four complexes and two mobile electron carriers

Complexes of respiratory chain are designated complex I, II, III and IV (integral parts of inner mitochondrial membrane). CoQ and cytochrome C are mobile electron carriers which act as a link between the complexes.

Complex	Components
I (NADH dehydrogenase)	FMN, Fe-S centers
II (Succinate dehydrogenase)	FAD, Fe-S centers
III (Cytochrome reductase)	cyt.b, cyt.c, Fe-S center
IV (Cytochrome oxidase)	cyt.a, cyt.a ₃ , copper (Cu ¹⁺ /Cu ²⁺)

Table 2. Components of electron transport chain

Complexes I, III and IV are proton pumps (trans-membrane and proteins) linked by CoQ and Cyt.c (mobile electron carriers)

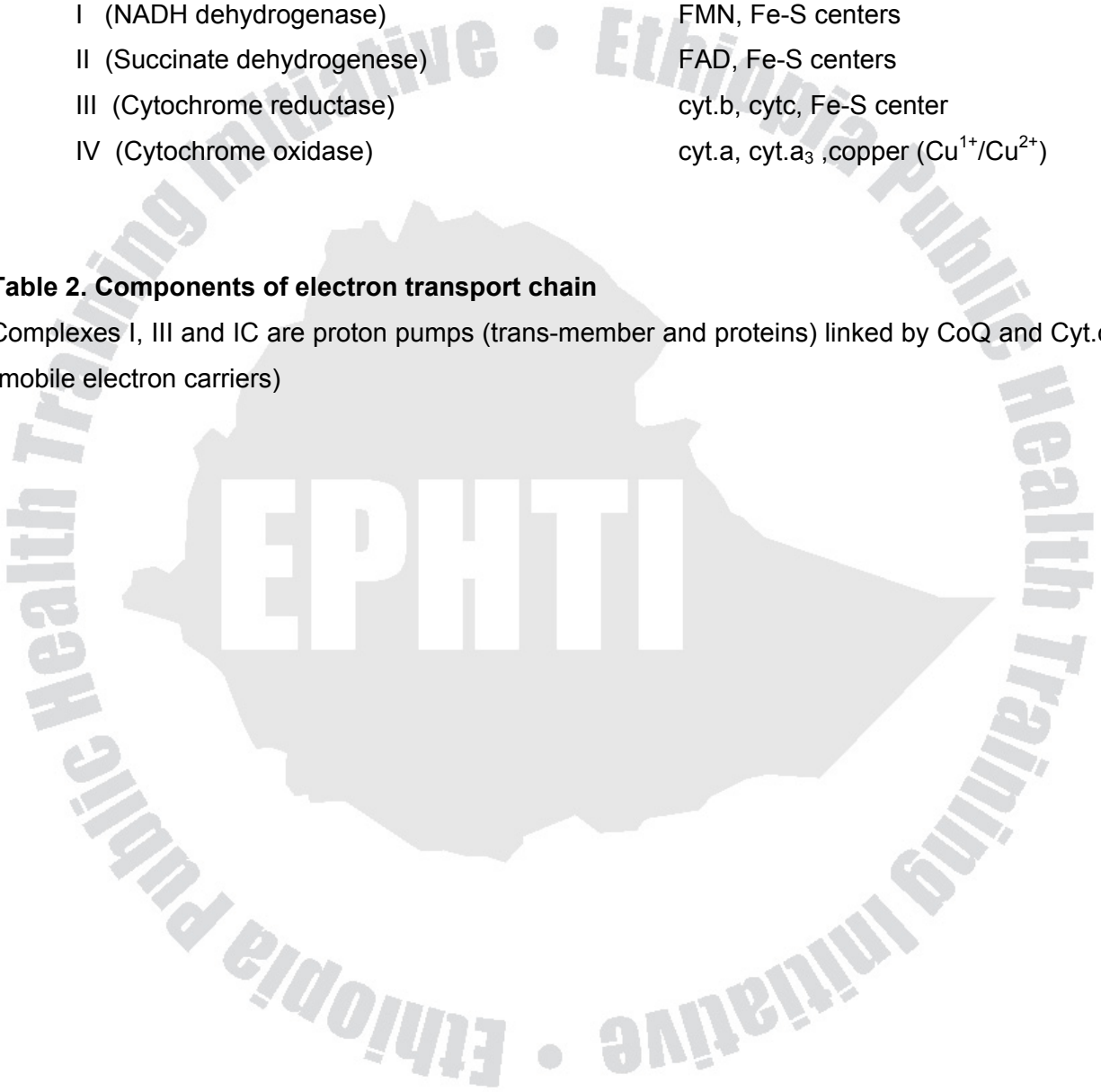

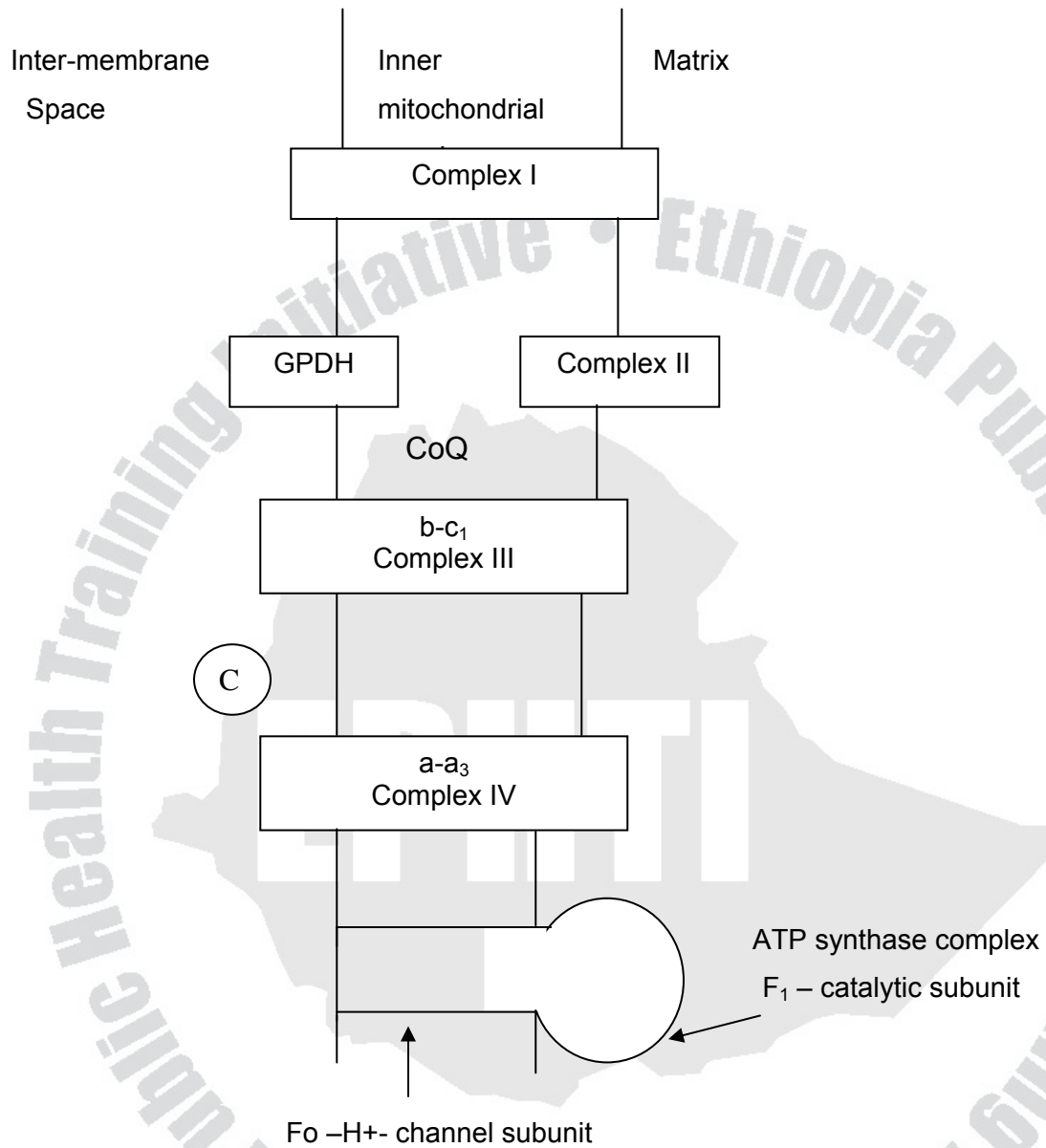
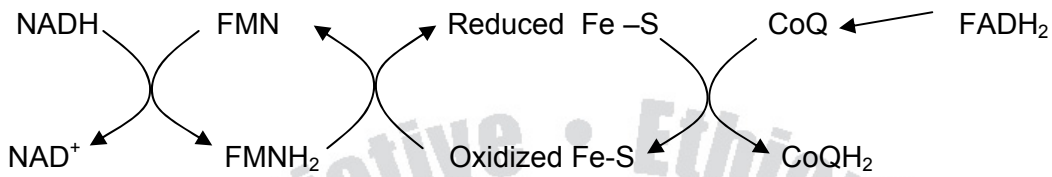

Fig 3.5. Arrangement of complex in electron transport chain

b - Oxidation of reducing equivalents (NADH & FADH₂) and electron flow through respiratory chain



Complex I

Electrons from NADH enter at complex I to be relayed to CoQ through series of carriers. Q also accepts a pair of electrons from FADH₂ prosthetic group of complex II (succinate dehydrogenase), glycerol phosphate dehydrogenase (GPDH) and fatty acyl dehydrogenase (FADH).

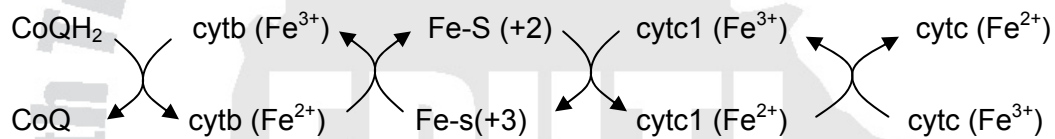

Complex III

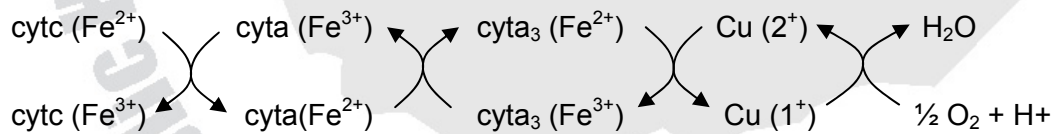

Complex IV

Every step of electron transport in the electron transport chain is accompanied by release of energy.

Useful energy is captured at three sites because large enough change in free energy (at least 9 - 10 Kcal/mole) occurs at three different sites when electron pairs flow down from NADH to O₂.

The large enough drop in free energy is occurs when electrons are transferred: within the NADH dehydrogenase complex, from NADH to CoQ, within cytochrome reductase from CoQ to Cyt.c, within cytochrome oxidase from cytc to O₂. Such drop in free-energy is more than enough to sponsor the synthesis of three ATP from 3ADP and 3P_i.

Flow of a pair of electrons from FADH_2 to O_2 exhibits only two large drops in free-energy, therefore sponsors the synthesis of only two ATP molecules. That is, the drop in free-energy as electrons pass from FADH_2 to CoQ is insufficient to sponsor ATP synthesis.

Oxidation of NADH releases more than enough free energy (-52.6kcal) needed for synthesis of 3ATP

Similarly oxidation of FADH_2 releases more than enough free energy for synthesis of 2ATP.

C- Coupling of Electron Transport and ATP Synthesis (Oxidative Phosphorylation)

- Electron transport and oxidative phosphorylation are coupled processes

Suggested hypotheses for coupling mechanism

High-energy intermediate serves as precursor of ATP

Activated protein conformation drives the synthesis of ATP

Proton gradient across inner mitochondrial membrane couples electron transport and ATP synthesis (chemiosmotic hypothesis of Peter Mitchell- postulated in 1961)

Mitchell's chemiosmotic is the accepted theory

According to chemiosmotic theory, electron - transport and oxidative phosphorylation are coupled by proton-gradient as follows. As electrons from NADH or FADH_2 flow down the respiratory chain to O_2 free energy is released. The free energy released is captured at three sites to pump protons against concentration gradient from matrix to inter membrane space generating proton gradient across inner mitochondrial membrane. As a result of this pH gradient is also formed, more positive (acidic) on the outer side more negative (basic) on the inner side of mitochondria. In this process a proton motive force of 0.22Volts is created across inner mitochondrial membrane. Now the kinetic energy of electrons is transformed into the proton – motive force. This force drives later ATP synthesis

This happens when protons are back translocated into matrix through the channel portion of ATP synthase (F_o) which is activated by electrochemical potential difference

across the membrane. Catalytic portion of ATP synthase (F_1) synthesizes ATP from ADP and P_i as protons are back translocated.

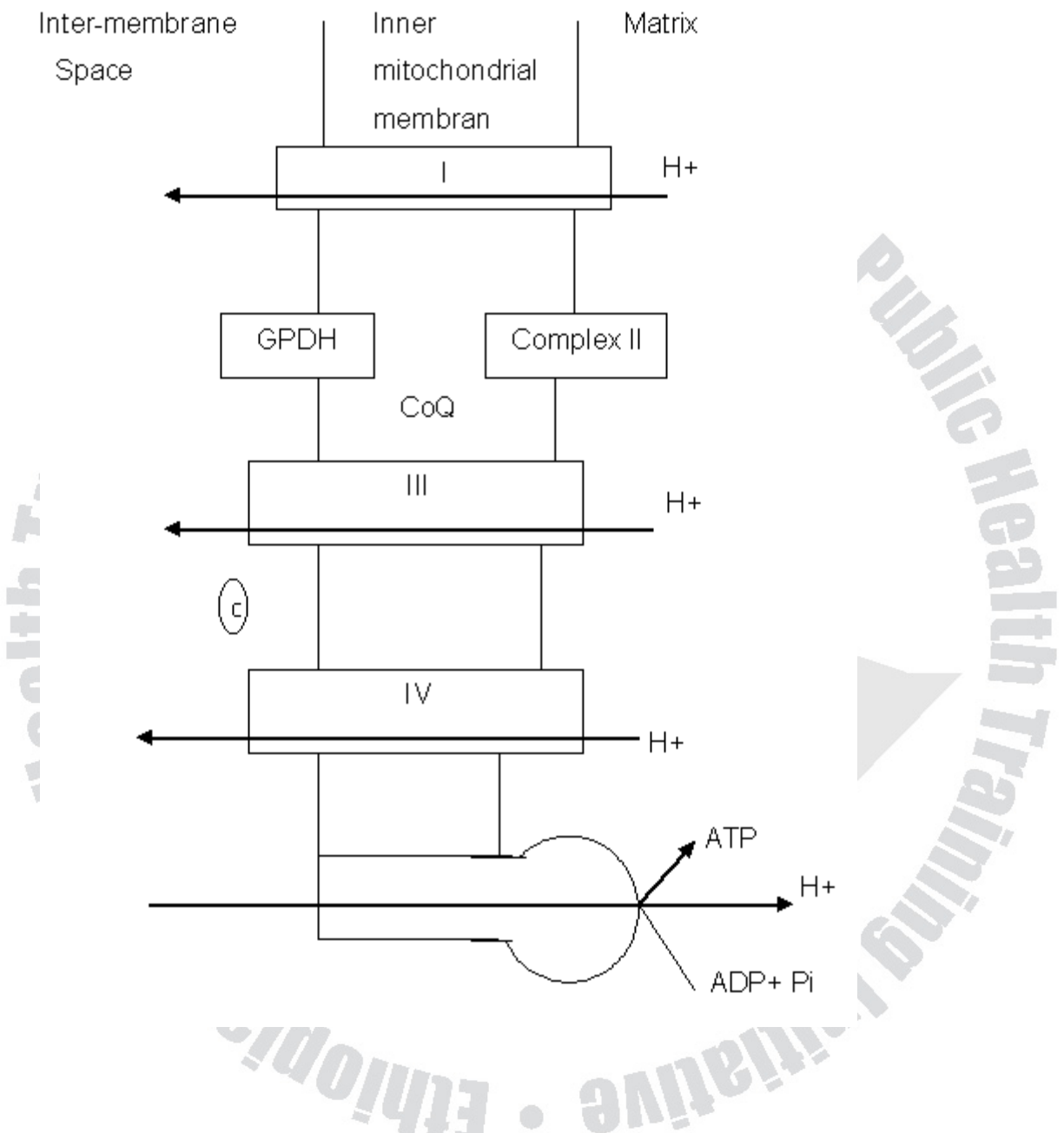

Fig 3.6. ATP synthesis coupled to electron transport

The precise number of protons pumped by each complex is not known with certainty

Current estimates - 3 - 4 H⁺ by complex I

- 4 H⁺ by complex II

- 2 H⁺ by complex IV.

Under cellular conditions, oxidation of:

NADH produces 3ATP from 3ADP and 3P_i

FADH₂ produces 2ATP from 2ADP and 2P_i

Fates of mitochondrial ATP

used by mitochondria energy (ATP) requiring process

translocation to cytosol (where most of ATP is used for biosynthesis) by

ATP – ADP translocase (antiporter)

d- Respiratory Control

The most important factor determining the rate of oxidative phosphorylation is the level of ADP which in turn is determined by the rate of ATP consumption cellular energy demand and utilization determines the rate of ATP synthesis through its effect on the level of ADP which controls the rates of oxidative phosphorylation and kreb's cycle

ATP synthesis requires availability of ADP also regeneration of oxidized coenzymes (NAD⁺ and FAD) required for Kreb's cycle requires ADP that can be phosphorylated to ATP

e- Uncoupling of Electron Transport and Oxidative Phosphorylation

Uncouplers are substances which uncouple electron transport and oxidative phosphorylation

In the presence of uncouplers:

electron transport proceeds

proton translocation by proton pumps proceeds

oxygen consumption proceeds

aerobic oxidations proceed without control

Proton gradient is not formed since uncouplers carry protons back to matrix through IMM not through ATP synthase (continuous dissipation of proton – gradient)

ATP synthase not activated

No ATP synthesis

Energy of oxidation lost as heat

Types of Uncouplers:

1. Chemical uncouplers – example 2, 4-dinitrophenol (2, 4-DNP) 2, 4, - DNP accepts proton and carries it into matrix through IMM (membrane permeable)

2. Physiological uncoupler – thermogenin (protein)

H⁺-channel in the IMM

Abundant in mitochondria of brown adipose tissue (low level of ATP synthase activity)

Responsible for diet induced thermo-genesis

Brown adipose tissue is absent or reduced in obese individuals

Present in newborns and cold adapted individuals

Thermogenin is opened by fatty acids liberated upon degradation of stored fat by activated hormone sensitive lipase by norepinephrine released in response to drop in body temperature due to cold environment.

Opening of thermogenin allows reentry of translated protons through IMM (no proton gradient formed)

No ATP synthesis

Energy of oxidation lost as heat

biological importance - maintain body temperature in newborns

- cold adaptation

f- Respiratory Poisons

Inhibit electron flow through respiratory chain

Inhibit proton translocation

Inhibit proton gradient formation

Inhibit O₂ consumption

Inhibit ATP synthesis

Reducing equivalents remain reduced

Other aerobic oxidation's inhibited

(Kreb's cycle, pyruvate oxidation, fatty acid oxidation)

<i>Inhibitor</i>	<i>Complex inhibited</i>
Rotenone	I
Amytal	II
Antimycin A	III
Cyanide (CN ⁻)	IV
Carbon monoxide (CO) , (Azide (N ₃ ⁻) CN ⁻ and CO inhibit cytochrome oxidase activity of complex.....	IV

F. Table 3. Inhibition of respiratory chain complexes

ATP synthesis is also inhibited by inhibition of ATP Synthase by oligomycin (blocks F_o portion)

Inhibition of complex IV and ATP Synthase arrest cellular respiration with fatal consequences.

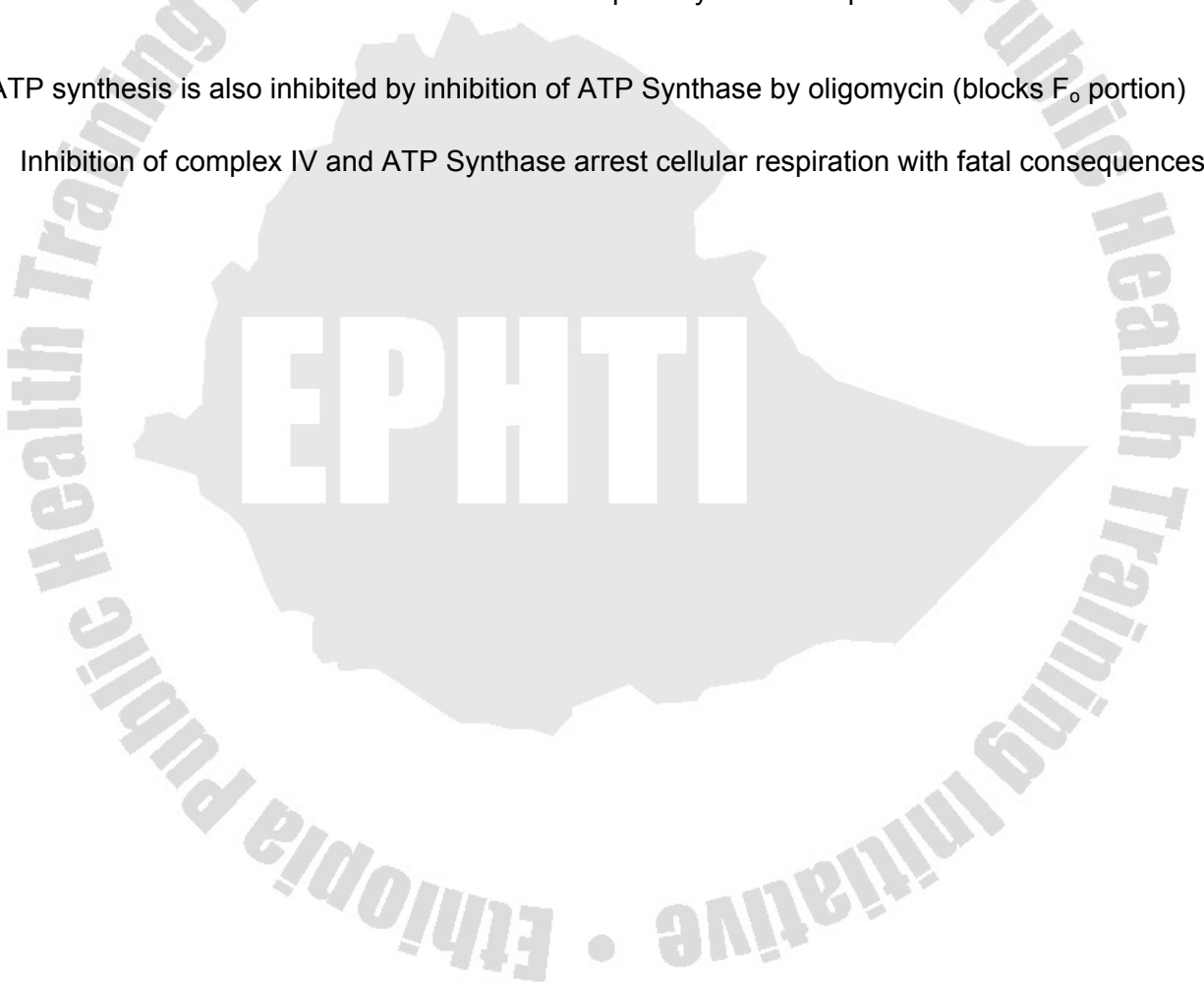

UNIT FOUR

LIPIDS

Lipids comprise very heterogeneous group of compounds which are insoluble in water but soluble in non-polar organic solvents such as benzene, chloroform, and ether. They are present in all living organisms. The group includes fats, oils, waxes and related compounds.

General Functions of Lipids

- i. They are efficient energy sources.
- ii. Serve as thermal insulators.
- iii. They are structural components of the cell membrane.
- iv. Serve as precursors for hormones (steroid hormones).
- v. They also dissolve the vitamins, which are fat-soluble and assist their digestion.

Classification: - There are two ways of classification i.e.,

- Classification as storage and structural lipids and some other functional lipids.
- Classification based on lipid composition.

I. **Simple lipids:**- esters of fatty acids with different alcohols.

Fats and oils:- These are esters of fatty acids with glycerol.

Waxes:- Esters of fatty acids with high molecular weight monohydric alcohols

II. **Complex lipids:**- Esters of fatty acids and alcohols together with some other head groups.

A. **Phospholipids:**- Esters of the above type containing phosphoric acid residue.

a) Glycerophospholipids:- The alcohol is glycerol

b) Sphingophospholipids:- The alcohol is sphingosine.

B. **Glycolipids:**- Lipids containing fatty acid, sphingosine and carbohydrate residues.

C. **Others:**- Include sulfolipids, amino lipids and lipoproteins, which are modified forms of lipids.

III. **Derived lipids:** include the hydrolytic products of the simple and complex lipids. Eg. Fatty acids, cholesterol etc.

The simplest naturally occurring lipids are triacylglycerols formed by esterification of fatty acids with glycerol. Biological membranes are made up of phospholipids, glycolipids and proteoglycans.

FATTY ACIDS

Fatty acids are building block of most lipids, made of long chain organic acids having one polar carboxyl group (head) and a non-polar hydrocarbon chain (tail). The latter makes them water insoluble. They are not found free in nature but found as esterified forms. Most naturally occurring fatty acids have got even number of carbons. They may be saturated or unsaturated, with one or more double bonds. Mostly the double bond occurs at the 9th carbon as we count from the carboxyl group end.

There are two systems of numbering the carbon atoms in a fatty acid

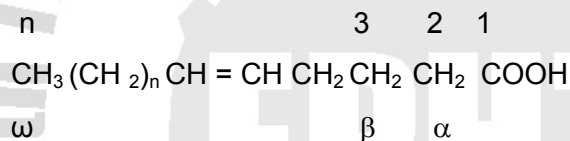

1. Numbering starts from carboxyl carbon. The last carbon is the "n" carbon
2. The second carbon is the "α" and the third the "β" Carbon. The last carbon atom is omega.

Eg:- $\text{CH}_3(\text{CH}_2)_7\text{CH}_2\text{CH}_2(\text{CH}_2)_7\text{COOH}$ stearic acid (saturated fatty acid)

Eg:- $\text{CH}_3(\text{CH}_2)_7\text{CH}=\text{CH}(\text{CH}_2)_7\text{COOH}$ oleic acid (Unsaturated fatty acid)

Fatty acids can be represented as shown below where the delta indicates the position of the double bond and the next number shows the number of carbon atoms and the last number indicates the number of double bonds. In a different way the position of the double bond(s) can be indicated as shown in the second expression without the delta.

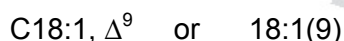

C₁₈ indicates 18 carbons, 1 indicates the number of double bonds, delta 9(Δ⁹) indicates the position of double bond between 9th and 10th carbon atoms.

- Double bonds in naturally occurring fatty acids are in the cis- configuration and saturated fatty acids of C₁₂ to C₂₄ are solids at body temperature but the unsaturated once are liquids.

PUFA (Polyunsaturated fatty acids): They have two or more double bonds .they are called as essential fatty acids because they are required in the body and cannot be synthesized. So they need to be include in the diet.

18	Linoleic acid	18: 2; 9 (12)
18	Linolenic acid	18: 2; 9 (12, 15)

These two are called essential fatty acids.

20	Arachidonic acid	20: 4; (5, 8, 11, 14)
----	------------------	-----------------------

Arachidonic acid is semi essential fatty acid because it can be synthesized from the above two essential fatty acids.

Functions:

1. The fluidity of membrane depends on length and degree of unsaturated fatty acids.
 Membrane PL contains essential fatty acids. In case of deficiency of EFA, other fatty acids replace them in the membrane; as a result membrane gets modified structurally and functionally.
2. They are required for the synthesis of PL, cholesterol ester and lipoproteins
3. Poly unsaturated fatty acids are released from membranes, diverted for the synthesis of prostaglandins, leukotriens and thromboxanes.
4. They act as fat mobilizing agents in liver and protect liver from accumulating fats (fatty liver).

TRIACYLGLYCEROLS

These are esters of fatty acids with the alcohol glycerol, which are storage forms of lipids (depot lipids). Triacylglycerols or also called as triacylglycerides, exist as simple or mixed types depending on the type of fatty acids that form esters with the glycerol. Both saturated and/or unsaturated fatty acids can form the ester linkage with the backbone alcohol. Eg. Tripalmitate, Triolein.

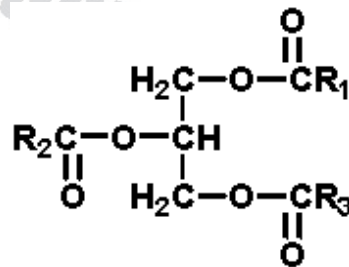
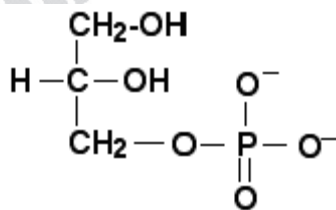

Fig 4.1. Structure of Triacylglycerol.R₁, R₂ and R₃ are fatty acids.

- Tristearin is a chief component of beef lipid
- Butter has short chain fatty acids.
- Unsaturated fatty acids are sensitive to air and oxidized to give rancid smell.
- Triacylglycerols are mainly found in special cells called adipocytes (fat cells), of the mammary gland, abdomen and under skin of animals.

They produce twice as much energy as that of carbohydrates per gram

STRUCTURE OF LIPIDS



D-glycerol-1-phosphate
 (same as L-glycerol 3-phosphate)
 backbone of *phospholipids*

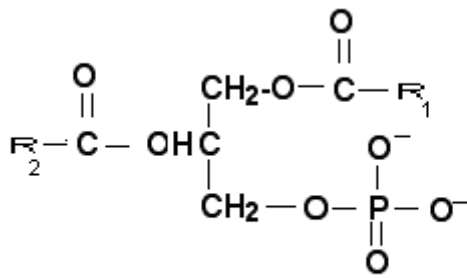

phosphatidic acid (phosphatidate)

R₁ and R₂ are fatty acids

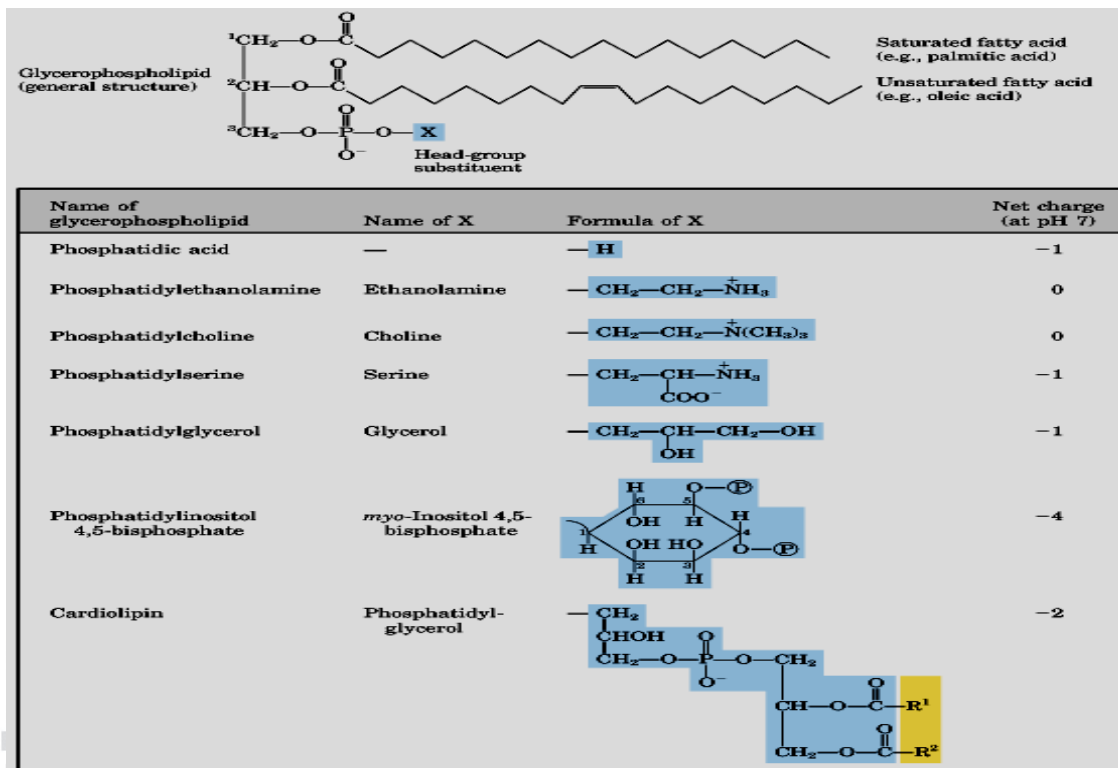
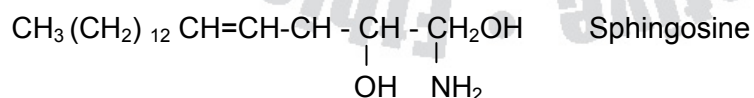

Fig 4.2. Structure of phosphatidate

Phosphatidate is the parent compound for the formation of the different glycerophospholipids. To the phosphate group different head alcohol may be attached. If choline is attached it is called phosphatidyl choline (lecithin), if ethanolamine is attached it is called phosphatidyl ethanolamine.

The second largest membrane lipids are sphingolipids, which contain two non-polar and one polar head groups. Their alcohol is the amino alcohol sphingosine.

Sphingolipids have subclasses viz., sphingomyelins, cerebrosides and gangliosides. Out of these only sphingomyelin contains phosphorus.



Sphingomyelins contain as head group phosphocholine or phosphoethanolamine. Below is an example of a sphingomyelin.

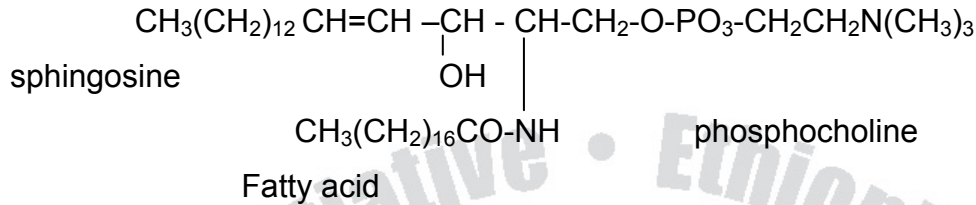

Gangliosides: These are glycolipids most of which are complex containing oligomers of sugars on head groups. One unit shall definitely be N-acetyl neuraminic acid (sialic acid) 6% of grey brain matter is ganglioside.

Cerebrosides:- These are glycolipids which have no phosphate group but neutral head group and contain one or two sugar groups usually glucose or Galactose Functions of phospholipids

1. Phospholipids are components of membrane; impart fluidity and pliability to the membrane.
2. Dipalmitoyl choline (lecithin) acts as surfactant and lowers the surface tension in alveoli of lungs. Lecithin along with sphingomyelin maintains the shape of alveoli and prevents their collapse due to high surface tension of the surrounding medium. Some premature infants can't secrete lecithin; therefore suffer from respiratory distress syndrome.
3. Intra cellular signals (for second messengers) like inositol triphosphate and diacylglycerol are generated from membrane PL, during the action of hormones.
4. PL anchors certain proteins to cell membranes. PL being amphipathic can interact with nonpolar and polar substances. They link proteins to nonpolar membranes.
5. Solubilization of cholesterol is done by amphipathic nature of PL.
6. Lipids are transported as lipoproteins, which require PL

CHOLESTEROL

- Compounds containing 27 carbon cyclopentanoperhydrophenanthrene structures with four rings labeled A to D. Steroids are complex fat-soluble molecules, which are present in the plasma lipoproteins and outer cell membrane. Cholesterol is one of the important non fatty acid lipid that is grouped with steroids.

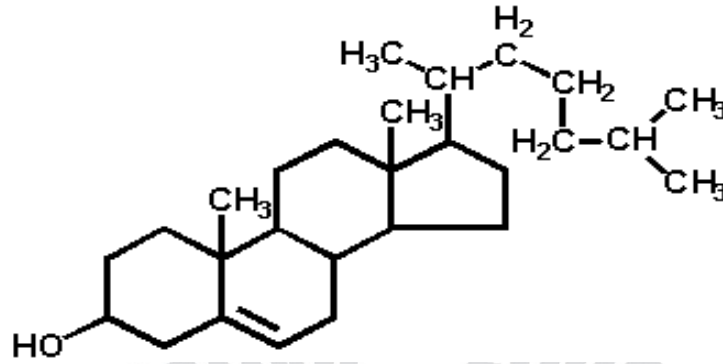

Fig 4.3. Structure of Cholesterol.

Cholesterol is important in many ways:

- For the synthesis of bile salts that are important in lipid digestion and absorption.
- For the synthesis of steroid hormones that are biologically important like the sex hormones estrogen and progesterone.
- For the synthesis of vitamin D₃
- As a structural material in biological membranes.
- As a component of lipoproteins as transport forms of lipid based energy.

Digestion and Absorption of Lipids

Diet contains triglycerides, cholesterol and its ester, phospholipids, fatty acids etc. Mouth and gastric juice has got lipase. It can hydrolyse fats without emulsification with bile salts. Milk fat and butter fat is digested by the enzyme.

Major part of fats are digested by pancreatic lipase. It acts on emulsified lipids only. The products are monoglyceride and 2 fatty acids. Monoglyceride is further hydrolyzed by another lipase. Thus 3 fatty acids and one glycerol molecule is produced from the digestion of dietary triglyceride.

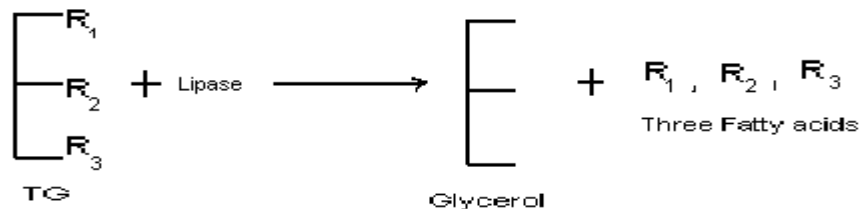

Fig 4.4. Action of lipase on TAG

phospholipids are digested by phospholipases, secreted by pancreas and intestines.

They are four in number, A (A₁, A₂) B, C, and D. The action of these enzymes are shown down below.

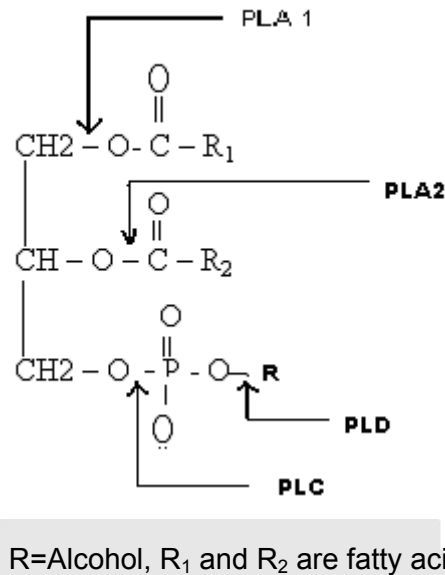

Fig 4.5: Action of phospholipases on phospholipids

The products of Phospholipase A₁ or A₂ are Lysophosphosphatidyl choline and one fatty acid, when the substrate is PC.

Phospholipase B acts on Lysophospholipid, produces glycerophosphoryl choline and free fatty acid.

Phospholipase C acts on phospholipids produce diglyceride and Phosphoryl choline.

Phospholipase D acts on phospholipids, produce choline and phosphatidic acid.

Cholesterol esterase hydrolyses cholesterol ester to free cholesterol and one fatty acid. The digested products are water soluble but some are insoluble.

Glycerol, short chain fatty acids enter portal blood directly. Cholesterol, long chain fatty acids are esterified and absorbed in form of micelles. Bile salts are required for the process. Impaired secretion of lipases from the pancreas and bile salts from liver results in failure in fat absorption and causes steatorrhea (excessive passage fatty stool). Absorption products of lipid digestion are absorbed from micelles. The micelles, through the intestinal lumen move to the brush border of the mucosal cells where they are absorbed into the intestinal epithelium.

The bile salts are reabsorbed and reach by enterohepatic circulation to the liver to be used over again. Their absorption is maximum in the ileum and jejunum. The free fatty acids and monoacylglycerols are absorbed through the epithelial cells lining the small intestine and pass to the lymphatic system where they join the systemic blood via the thoracic duct. The intestinal mucosa secretes into the lymph, the absorbed lipids as chylomicrons and VLDL. The former have short life in blood (<1hr) and make plasma milky after rich meal. The free fatty acids in blood (long chain) are bound to albumin and transported by blood to the liver.

Metabolism of Fatty Acids and Triacylglycerols

The triacylglycerols play an important role in furnishing energy in animals. They have the highest energy content over 9kcal/mole. They provide more than half the energy need of some organs like the brain, liver, heart and resting skeletal muscle.

Mobilization of Fatty Acids from Adipocytes

When the energy supply from diet is limited, the body responds to this deficiency through hormonal signals transmitted to the adipose tissue by release of glucagon, epinephrine, or adrenocorticotrophic hormone.

The hormones bind to the plasma membranes of adipocyte cells and stimulate synthesis of cyclicAMP (cAMP). The cAMP activates a protein kinase that phosphorylates and in turn activates hormone-sensitive triacylglycerol lipases (see the mechanism action of Hormones). These lipases hydrolyze the triacylglycerols at position 1 or 3 to produce diacylglycerols (DAG) and fatty acid, which is the rate limiting step in the hydrolysis. The diacylglycerol lipases hydrolyze the DAG to monoacylglycerols (MAG) and a fatty acid. Finally MAG lipases hydrolyze MAG to fatty acid and glycerol.

The free fatty acids (FFA) produced by lipolysis move through the plasma membranes of the adipose cells and endothelial cells of blood capillaries by simple diffusion and bind to albumin in the blood plasma, which are transported to peripheral tissues. The glycerol produced is taken up by liver, phosphorylated and oxidized to dihydroxyacetone phosphate, which is isomerized to glyceraldehydes-3-phosphate, an intermediate of both glycolysis and gluconeogenesis. Therefore, the glycerol is either converted to glucose (gluconeogenesis) or to pyruvate (glycolysis).

D. Transport of Fatty Acids to the Mitochondria

The fatty acids transported to the different tissue cells must first be activated or primed by reaction with Coenzyme A at the expense of ATP. The reaction is catalyzed by AcylCoA synthetase or also called thiokinase, found in the cytosol and mitochondria of cells. The pyrophosphate generated from ATP favors more Acyl CoA formation by further hydrolysis. In order to undergo β -oxidation, the fatty acids must enter the mitochondria. But they cannot easily cross it as such by passive diffusion.

There are two fatty acid sources viz., those coming from absorption of FFA and those from hydrolysis of triacylglycerols from adipose tissue. The transport of acyl derivatives across the mitochondrial membrane needs three acyltransferases (shuttles).

1. Specific for short chain acyl groups, does not require carnitine
2. Specific for the long chain acyl groups. The shuttles for long chain acyl groups are carnitine acyltransferase I and II. Therefore, long chain acyl groups cross the mitochondrial membrane in combination with carnitine.

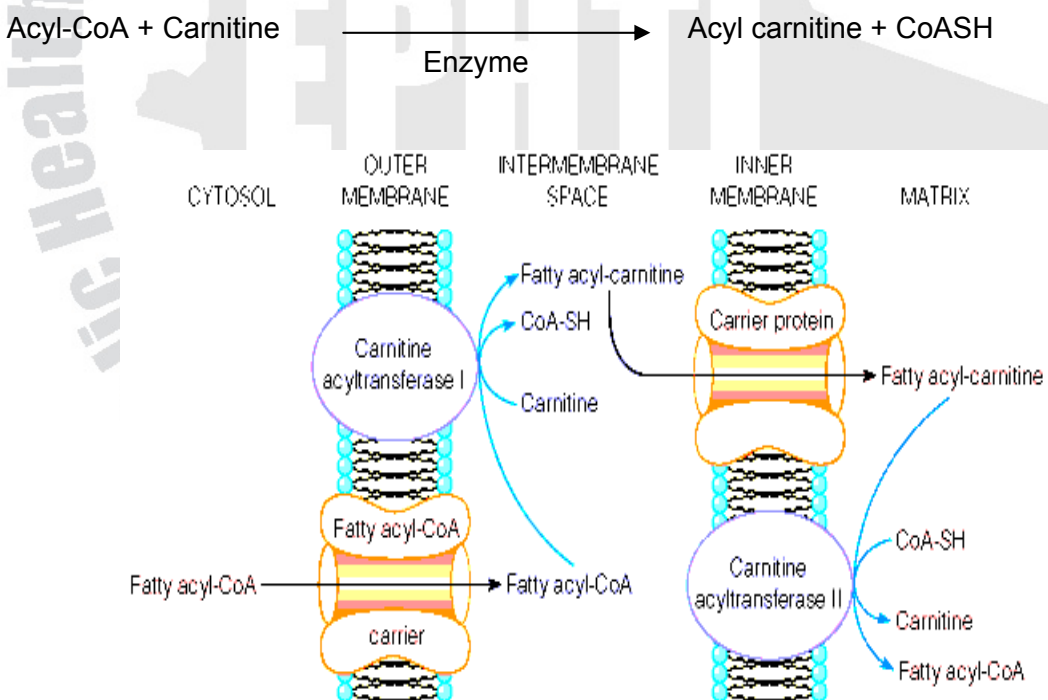

Fig 4.6. Carnitine transport system.

The carnitine pools are in the cytosol and mitochondria, abundant in muscle and it is synthesized from the amino acids lysine and methionine in the liver and kidney. The other name of carnitine is β -hydroxy- γ - trimethyl ammonium butyrate. Carnitine acyl transferase I, found in the surface of the outer mitochondrial membrane, catalyzes the acyl transferase reaction from acylCoA to the carnitine. It passes through the outer membrane to the inner membrane of mitochondrion. In the final stage of the transport, the fatty acyl group is released from the carnitine to the intramitochondrial CoASH by carnitine acyltransferase II, which is found in internal surface of the inner mitochondrial membrane. The regenerated acyl CoA is released to the matrix. It is worth noting that acyltransferase I is a regulatory enzyme in β -oxidation. The acyl CoA present in the matrix of the mitochondrion is now ready for β -oxidation.

β -oxidation of Fatty Acids

The successive oxidative removal of two carbons in the form of acetyl-CoA beginning from the carboxyl end is called β -oxidation. It requires a set of enzymes. The oxidation is so called because the β carbon is oxidized during the oxidation process. It takes place in the matrix of mitochondria.

Energy needs of tissues are met by the oxidation of free fatty acids, released by adipose tissue. Fatty acids are activated with the help of thiokinase, prior to transport to mitochondria. Overall activation of fatty acid requires hydrolysis of two phosphodiester bonds.

1. Acyl CoA dehydrogenase converts acyl CoA to acyl trans enoyl CoA
2. Hydratase converts it to 3-hydroxy acyl CoA.
3. Hydroxy acyl CoA dehydrogenase converts it to 3keto acyl CoA.
4. It is further converted to acyl CoA and acetyl CoA. by Thiolase

The cycle is repeated 7 times for palmitic acid for complete oxidation. See the figure

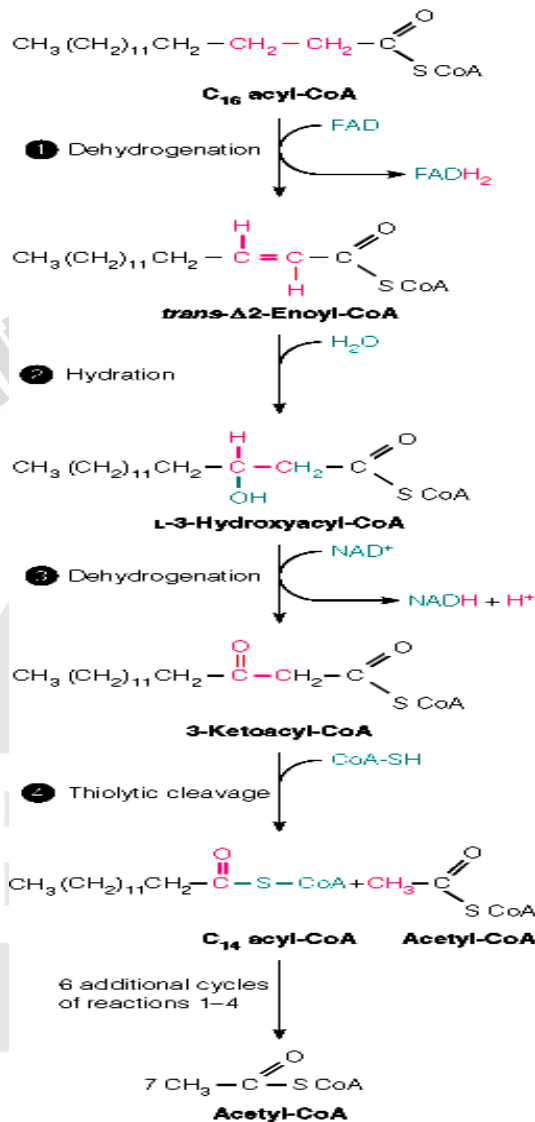

Fig 4.7: β-oxidation of fatty acid

The FADH₂ and NADH + H⁺ join the electron transport chain as high energy electron carriers. The latter donates its reducing equivalents (hydrogens) to NADH dehydrogenase to produce 3ATP per pair of electrons and the former produces only 2ATPS.

Complete oxidation of fatty acid can be divided into two stages.

A. Formation of acetyl CoA.

B. Oxidation of acetyl CoA to CO₂, water via TCA cycle.

Stoichiometry of the reaction:



Energetics of palmitate oxidation:

Reduced equivalents enter ETC and produce energy rich phosphate bonds. Acetyl CoA release energy through TCA cycle.

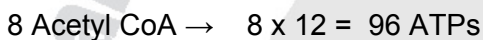
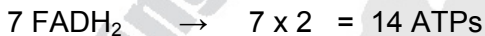

Total ATP produced from one molecule of palmitic acid is 131. Two ATPs (Two energy rich bonds) are utilized, during activation of fatty acid. Therefore total gain of ATPs is 129.

Oxidation of Unsaturated Fatty Acids

The oxidation of unsaturated fatty acids requires two additional enzymes called isomerase and reductase. Most naturally occurring unsaturated fatty acids are in cis- configuration, which are not suitable for the action of enoyl-CoA hydratases and hence they must be changed to their trans isomer by an isomerase. The rest of the enzymes are needed for the oxidation in addition to these two for the oxidation are the same.

Oxidation of Fatty Acids with Odd Number of Carbons

Ruminant animals can oxidize them by β - oxidation producing acetylCoAs until a three carbon propionylCoA residue is left. The acetylCoAs produced are funneled to the Krebs cycle but the propionylCoA produced is converted to succinylCoA by three enzymatic steps. SuccinoyCoA is an intermediate in the Krebs cycle and it can be metabolized.

The fates of acetyl-CoA formed by β -oxidation of fatty acids are:

1. Oxidation to CO_2 and H_2O by citric acid cycle.
2. Synthesis of lipids like cholesterol, fatty acids and other steroids.
3. Formation of ketone bodies in the liver.

Regulation of Oxidation of Fatty Acids

- Hormones regulate lipolysis, in adipose tissue. More free fatty acids are available for the β -oxidation.
- Insulin inhibits lipolysis.
- Acylcarnitine transferase-1 is inhibited by malonyl CoA, one of the intermediates of fatty acid synthesis.
- High level of NADH inhibits acyl CoA dehydrogenase.
- Increased concentration of acetyl CoA inhibits Thiolase.
- When the animal is well fed by carbohydrate, fatty acid oxidation is lowered.

The metabolism of Ketone Bodies

When the level of acetyl CoA from β -oxidation increases in excess of that required for entry into the citric acid cycle, it undergoes ketogenesis in the mitochondria of liver (ketone body synthesis). The three compounds viz., acetoacetate, β -hydroxybutyrate, and acetone are collectively known as ketone bodies. The synthesis of ketone bodies takes place during severe starvation or severe diabetes mellitus. During such conditions, the body totally depends on the metabolism of stored triacylglycerols to fulfill its energy demand.

In the synthesis, two molecules of acetyl CoA condense together to form acetoacetyl CoA, a reaction catalyzed by thiolase. Another molecule of acetyl CoA reacts with the acetoacetyl CoA to form 3-Hydroxy-3-methyl glutaryl CoA (HMGCoA). This step is the rate limiting step and the reaction is catalyzed by HMGCoA synthase enzyme. Note that this compound is also an intermediate in the synthesis of cholesterol in the liver cell cytosol but the mitochondrial HMGCoA goes to ketone body synthesis.

The HMGCoA formed in the hepatocytes mitochondria by the action of the enzyme HMGCoA lyase is changed to acetoacetate.

The acetoacetate, when its concentration is very high in blood is spontaneously decarboxylated to acetone.

Acetoacetate can be converted to β -hydroxy butyrate by a dehydrogenase enzyme. It is a reversible reaction. See the figure

The odor of acetone may be detected in the breath of a person who has a high level of acetoacetate, like diabetic patients. During starvation and severe diabetes mellitus peripheral tissues fully depend on ketone bodies. Even tissues like the heart and brain depend mainly on ketone bodies during such conditions to meet their energy demand.



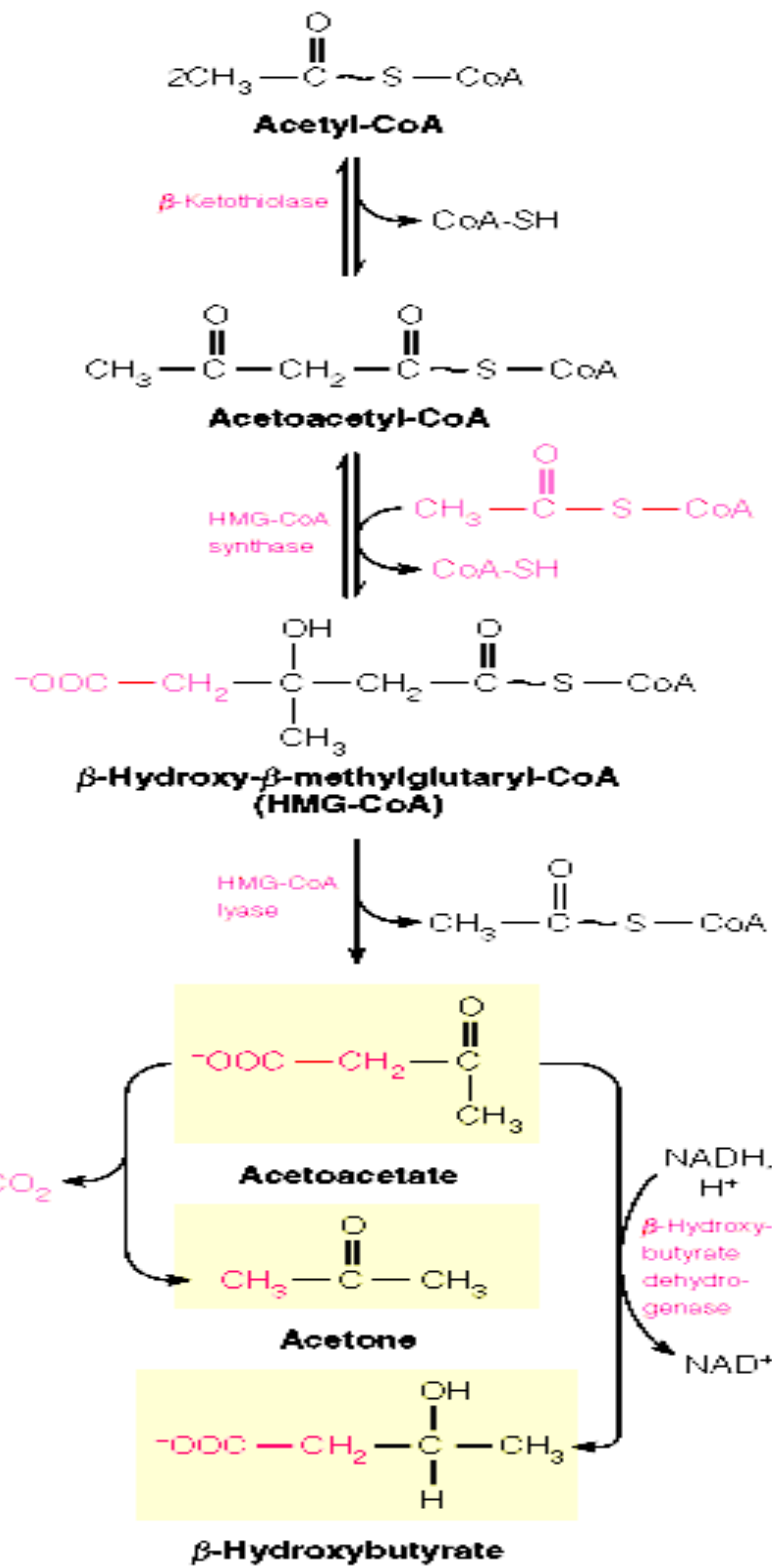

Fig 4.8. Synthesis of ketone bodies.

Regulation of Ketone Body Synthesis

It is regulated by

- Rate of β -oxidation
- Availability of substrates to enter TCA cycle
- Mobilization of carbohydrate stores

Utilization of Ketone Bodies

Ketone bodies are produced in the Liver and they are utilized in extrahepatic tissues. Liver does not contain the enzyme required for activation of ketone bodies

Aceto acetate is activated by two processes for its utilization.

1. Aceto acetate + ATP + CoA \rightarrow Acetoacetyl CoA + AMP. The enzyme is Synthetase
2. Aceto acetate + Succinyl CoA \rightarrow Aceto acetyl CoA + Succinate. The enzyme is Thiophorase(Absent in Liver)

Aceto acetyl CoA is broken down to two molecules of Acetyl CoA, which enters TCA cycle for the production of energy.

Aceto acetate and β -hydroxy butyrate are the normal substrates for respiration and important sources of energy .Renal cortex and heart muscle use acetoacetate in preference to glucose .Brain switches over to utilization of ketone bodies for energy during starvation and in uncontrolled diabetes.

Acetone is exhaled out .It does not produce energy. Normal level of ketone bodies in blood is 1mg %.In ketonemia, the level increases. Excretion of ketone bodies increases in urine, called ketonuria. If the patient suffers from both the signs, it is called ketosis.

Causes of Ketosis:

1. Prolonged starvation, depletion of carbohydrate stores results in increased fatty acid oxidation and ketosis.
2. Lactating mothers develop ketosis, if the carbohydrate demands are not met with.
3. Diabetic patients with uncontrolled blood glucose, invariably suffer from ketosis, ketoacidosis.

Ketosis usually associated with sustained high levels of free fatty acids in blood. Lipolysis and ketogenesis are regulated by hormones.

In Diabetes, there is lack of insulin, which brings about lipolysis and decreased utilization of glucose.

Lipolysis increases free fatty acids in blood, which are oxidized to meet energy requirements. This causes increased production of acetyl CoA, NADH, ATP which in turn inhibits TCA cycle.

Acetyl CoA requires oxaloacetate to enter TCA cycle. Since oxaloacetate is not forming from glucose, acetyl CoA can't enter the cycle. It is diverted to ketone bodies synthesis.

Similarly in starvation, due to hypoglycemia, there is less insulin, lipolysis increases and ketogenesis increases. Oxaloacetate is also diverted to gluconeogenesis, which further depletes TCA cycle. So acetyl CoA can only be converted to ketone bodies.

The Biosynthesis of Fatty Acids

Apart from diet fatty acids can be synthesized in the body.

Denovo synthesis of fatty acids take place in cytosol of liver, lactating mammary gland, adipose tissue and renal cortex.

Main site for TG, fatty acid synthesis is adipose tissue.

- * Acetyl CoA is converted to Malonyl CoA by acetyl CoA carboxylase.
- * Malonyl CoA and acetyl CoA are attached to acyl carrier protein (ACP).
- * Malonyl ACP acetyl ACP get condensed to ketoacyl ACP, by condensing enzyme.
- * Ketoacyl ACP gets reduced to hydroxyl acyl ACP by a reductase. It requires NADPHH.
- * It loses one molecule of water, forms 2-enoyl acyl ACP. Enzyme is dehydratase.
- * It undergoes reduction and forms Butyryl ACP. NADPHH and reductase are needed for the reaction.

The formation of malonyl CoA is the committed step in fatty acid synthesis

For the synthesis, all the enzymes are required in the form of fatty acid Synthase complex.

1. Ketoacyl Synthase (condensing enzyme).
2. Ketoacyl reductase
3. Dehydratase
4. Enoyl acyl ACP reductase
5. Thioesterase.

Acetyl CoA + 7 malonyl CoA + 14NADPH = Palmitoyl CoA + 7CoA +7CO₂ +14 NADP +7H₂O.

The main sources of NADPH for fatty acid synthesis are the pentose shunt but the malic enzyme reaction has also a small contribution.

The formation of malonyl CoA is the committed step in fatty acid synthesis

For the synthesis, all the enzymes are required in the form of fatty acid Synthase complex.

Stoichiometry of the reaction

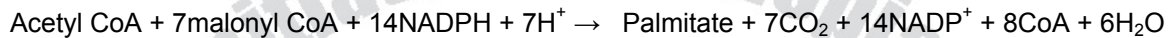

Hence the overall stoichiometry for the synthesis is:

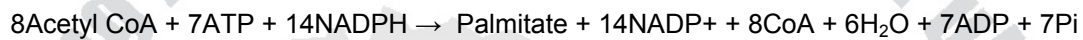

Regulation o Fatty Acid Synthesis:

- High carbohydrate diet increases synthesis.
- Palmitoyl CoA inhibits synthesis
- Fasting decreases acetyl carboxylase, decreases fatty acid synthesis.
- Insulin stimulates fatty acid synthesis.

Biosynthesis of Triacylglycerols

1. Major pathway: 2.Activate fatty acids are attached to glycerophosphate to form phosphatidic acid ,by acyl transferase.It is converted to diglyceride by the removal of phosphate group by phosphatase.Another fatty acid is attached to the diglyceride to form triglyceride.The synthesis takes place in adipose tissue and Liver.
2. Minor pathway: Monoglyceride is acylated to form diglyceride .It is later converted to triglyceride by addition of one more fatty acid.The process is seen during absorption of Lipids.

Biosynthesis of Cholesterol

Cholesterol is synthesized in the cell cytosol and endoplasmic reticulum from acetylCoA. Liver and intestine account each for 10% of the total cholesterol synthesized in the body. Almost all tissues containing nucleated cells can synthesize cholesterol. The synthesis follows five major steps which include:

- Acetyl CoA is converted to HMG CoA.

- HMG CoA is reduced to Mevalonate by a reductase.
- Mevalonate undergoes three times Phosphorylation, in the presence of 3 ATPs and various kinases. The product is 3-phosphor-5 pyrophospho mevalonate.
- Dephosphorylation, decarboxylation converts it to Isopentenyl pyrophosphate.
- It is isomerised to dimethyl allyl pyrophosphate by isomeras.
- Isopentenyl pyrophosphate and dimethyl allyl pyrophosphate form Geranyl PP(10C).
- Geranyl PP and one more molecule of Isopentenyl PP → Farnesyl PP(15C).
- Two of Farnesyl PP join to form Squalene (30C).

1. Squalene undergoes cyclization, loses three carbon atoms, acquire a double bond, forms cholesterol

Regulation of Cholesterol Synthesis:

Acetyl CoA is converted to Mevalonate. It is the committed step in the synthesis of cholesterol.

Almost 800 mg of cholesterol is synthesized in our body .HMG CoA reductase is the regulatory enzyme.

1. Dietary cholesterol inhibits endogenous synthesis.
2. Fasting leads to low levels of the key enzyme.
3. Insulin activates protein phosphatase which converts it to active enzyme. Glucagon decreases its activity through c AMP dependent protein kinase.
4. Whenever ATP levels are low, the enzyme is switched off by AMP activated protein kinase.
5. m RNA for HMG CoA reductase is under the control of sterols . High concentration of sterols inhibits the synthesis of m RNA, there by the synthesis of enzyme.
6. High levels of degradation products lead to rapid degradation of HMG CoA reductase.

Catabolism of Cholesterol:

Intestinal Bacteria converts cholesterol to coprostanol which is excreted in feces. Cholesterol breaks down to cholic acid and chenodeoxycholic acid. Both are bile acids. They combine with sodium, Potassium to form bile salts. The key enzyme α -hydroxylase is inhibited by high concentration of bile acids.

Functions of Bile Salts

- **They lower** surface tension ,emulsify fats ,a pre requisite for the action of pancreatic lipase
- They activate Lipase.
- They shift the pH from 9 to 6
- They form micelles with fatty acid,a mono,di,triglyceride and help in absorption
- Promote absorption of fat soluble vitamins
- Bile salts keep cholesterol in soluble form in gall bladder.
- They regulate the breakdown of cholesterol

Cholelithiasis (Gall stones):

Absence of bile salts precipitate cholesterol as gall stones.Solubility of cholesterol depends on the ratio of phospholipids, bile salts to cholesterol.Due to infections bile acids are destroyed which leads to decreases solubility of cholesterol.

Decrease of bile salts can be due to:

- A. Failure in enterohepatic circulation
- B. Cirrhosis of Liver
- C. Disease of ileum.

The patients are treated with chenodeoxycholic acid to solublize the cholesterol or the stones are removed by surgical intervention.

Hypercholesterolemia :

Normal cholesterol level is 150-250mg% in blood.

High concentration leads to hypercholesterolemia.

Excess cholesterol gets deposited under the skin, tendons as Xanthomas.

In some cases the regulatory enzyme HMG-CoA reductase is not sensitive to feed back regulation. Such people suffer from familial hypercholesterolemia.

Atherosclerosis:

Deposition of lipids in the connective tissues of intima of arteries is called atherosclerosis. It causes obstruction to blood flow, leading coronary heart disease, stroke, myocardial infarction etc.

The process is initiated when there is injury to endothelial cells of blood vessels. A number of factors are responsible for injury .The condition is compounded by hyper lipidemia.

Atherogenesis is the process by which **atherosclerotic plaques** form, a critical step in the disease, **atherosclerosis**.

Low-density lipoprotein complexes (**LDLs**), which are the primary means of transporting **cholesterol** in the blood, are readily oxidized.

A class of white blood cells recognizes the oxidation and absorbs the LDL through its scavenger receptor. They becomes engorged and is referred to as a foam cell.

Foam cells attract other white blood cells, which leads to accumulation of more cholesterol.

Ultimately, this accumulation of cholesterol becomes one of the chief chemical constituents of the **atherosclerotic plaque** that forms at the site.

Circulating monocytes accumulate at the site of injury, ingest excess of lipids.

If the damage to the intima continues, there is infiltration of platelets at the site.

Foam cells and platelets aggregate, and release substances resulting in atheromatic plaque.

Hypercholesterolemic Drugs

- **Compactin** inhibits HMG CoA reductase. Cholesterol synthesis decreases.
- **Mevinolin** Competes for Mevalonate ,Cholesterol synthesis decreases
- **Cholestepol**, cholesteyramine (Resins) combine with bile salts and inhibit their reabsorption. Here Bile salts are lost in feces. As a result more cholesterol breaks down to bile salts.
- **Diatery fiber** is not a drug, better than a drug because
 - Bile salts gets trapped in fiber and lost in feces.
 - More cholesterol breaks down
 - Cholesterol absorption is decreased because of indigestible fiber
 - All other lipids are absorbed less.

Lipid Storage Diseases

Lipid storage diseases are also called as sphingolipidosis. They are degraded by hydrolytic enzymes found in lysosomes. When the degradation is impaired; sphingolipids accumulate in the tissues.

1. Nieman-pick disease

Sphingomyelin accumulates in brain, liver and spleen. The condition is due to deficiency of sphingomyelinase. Patient suffers from mental retardation and early death.

2. Gaucher's disease.

Glucocerebroside accumulates in liver, spleen, brain and bone marrow, due to the deficiency of glucocerebrosidase. Patient suffers from mental retardation.

3. Tay-Sach's disease.

Hexoseaminidase is absent as a result gangliosides accumulate in brain, spleen and retina. Patient suffers from demyelination. Cerebral degeneration, mental retardation and early death.

Fatty Liver:

Excess accumulation triglycerides in liver causes fatty liver, Liver cirrhosis and failure of liver function.

Causes are:

- Elevated levels of free fatty acid in blood
- Deficiency of lipotropic factors, which help in the mobilization of fat from liver
- Failure in the secretion of lipoproteins from liver
- Chronic alcoholism
- Prolonged treatment with antibiotics

Lipoproteins

Plasma lipids contain triacylglycerols, cholesterol and other polar lipids. Lipids combined with apolipoproteins to form Lipoproteins. Based on their density they are classified into four subgroups:

Chylomicrons:

These are derived from intestinal absorption of triacylglycerols and other lipids and have a very short lifespan. They have the least density and richly consist TAG. Chylomicrons transport dietary triacylglycerols and cholesterol from the intestine to the liver for metabolism.

VLDL (very low density lipoproteins):

These are synthesized in the liver and used to transport triacylglycerols from the liver to extrahepatic tissues.

LDL (Low density lipoproteins):

These are produced from the final stage in the catabolism of VLDL. They transport cholesterol synthesized in the liver to peripheral tissues. LDL is metabolized via the LDL-receptor. Approximately 30% of the LDL is degraded in extra hepatic tissues, rest is degraded in liver.

HDL (High Density Lipoproteins):

HDL has the highest density in this group since it contains more protein and cholesterol than triacylglycerols. It transports excess cholesterol from peripheral tissues to the liver for degradation and removal. Therefore, HDL cholesterol is good cholesterol but LDL cholesterol is called bad cholesterol.

High concentration of circulating VLDL, LDL are indicative of possible atherosclerosis. Elevated HDL is a good sign which indicates less chances of atherosclerosis. There is a correlation between the incidence of coronary heart disease and low level of HDL. The higher the ratio of HDL/LDL, the less the chances of CHD.

Lipids and Membranes

Membranes are important biological structures, which are indispensable for life. Membranes give cells their individuality by separating them from their surrounding and they are highly selective and semi permeable containing specific gates, pumps, and channels. Membranes control the flow information between cells and their environment since they contain specific receptor molecules in the form of glycoproteins.

Chemical Composition of Membranes

Phospholipids are the major class of membrane lipids. Cholesterol, glycoproteins and glycolipids are also the other components of membranes. Glycerophospholipids like lecithin, cephalin and phosphatidyl serine. Membranes are mainly formed of phospholipid bilayers. Sphingolipids also form membrane structures, especially that of the brain cells and nerve cells.

Structure of Membranes

All membranes have a bimolecular leaf of lipid bilayers. Proteins are found submerged in the sea of the lipid bilayers (intrinsic proteins) or loosely bound (extrinsic proteins) and cholesterol is also found intercalated between the lipid bilayers giving the fluidy nature of membranes. The integral proteins contain sugar oligomers and most of them function as receptors. Some of the characteristic features of membranes are listed below.

Membranes can be regarded as a sea of lipid bilayers and due to the presence of unsaturated fatty acids and cholesterol. This fluidity enables lateral diffusion of molecules such that integral and non-integral proteins span the whole membrane structure. This implies that membranes are not rigid structures but dynamic structures. The modern representation of lipids as fluidy and dynamic structures is called the *fluid mosaic model*. The molecules forming membrane structures do not flip-flop or undergo traverse diffusion and therefore, membranes are asymmetric structurally and functionally. The outer and inner surfaces of all known biological membranes have different components and different enzymatic activities.

UNIT FIVE

AMINO ACIDS

Introduction

There are approximately 300 amino acids present in various animals, plants, and microbial systems, but only 20 amino acids are coded by DNA to appear in proteins.

Cells produce proteins with strikingly different properties and activities by joining the same 20 amino acids in many different combinations and sequences. This indicates that the properties of proteins are determined by the physical and chemical properties of their monomer units, the amino acids.

Definition:

Amino acids are the basic structural units of proteins consisting of an amino group, (-NH₂) a carboxyl (-COOH) group a hydrogen (H) atom and a (variable) distinctive (R) group. All of the substituents in amino acid are attached (bonded) to a central α carbon atom. This carbon atom is called α because it is bonded to the carboxyl (acidic) group.

The general formula for the naturally occurring amino acids would be :

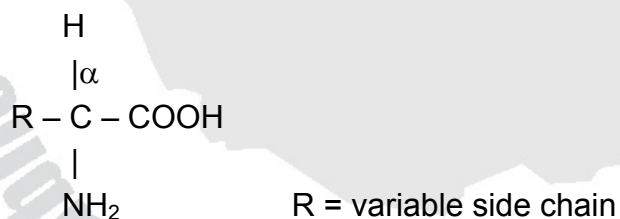
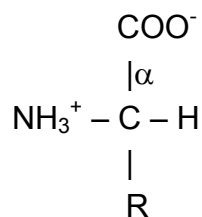

Fig 5.1 : General formula of Amino acids

- A basic amino group (-NH₂)
- An acidic carboxyl group (-COOH)
- A hydrogen atom (-H)
- A distinctive side chain (-R)

In neutral solution (PH = 7), both the α - amino and α carboxyl group are ionized resulting the charged form of an amino acids called zwitterion (dipolar) as shown in the figure below.



In dipolar (zwitterion) form the amino group is protonated ($-\text{NH}_3^+$) and the carboxyl group is dissociated (deprotonated) ($-\text{COO}^-$) leading to a net charge zero.

Stereochemistry (Optical activity)

Stereochemistry mainly emphasizes the configuration of amino acids at the α carbon atom, having either D or L- isomers.

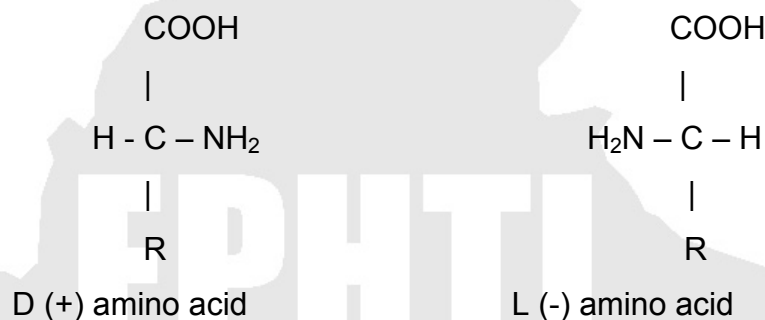

Fig 5.2: D and L- forms of Amino acids

Out of the 20 amino acids, proline is not an α amino acid rather an α - imino acid. Except for glycine, all amino acids contain at least one asymmetric carbon atom (the α - carbon atom).

Classification of Amino Acids

L-Amino acids are the building blocks of proteins. They are frequently grouped according to the chemical nature of their side chains. Common groupings of amino acids are **aliphatic, hydroxyl/sulfur, cyclic, aromatic, basic, acidic and acid amides**. Links to individual **amino acids** are given below:

I. Structural Classification

This classification is based on the side chain radicals (R-groups) as shown in the table 5.1. Each amino acid is designated by three letter abbreviation eg. Aspartate as Asp and by one letter symbol D.

Table 5.1 : Structural classification of Amino acids

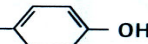
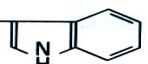
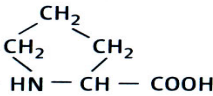
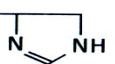
The 20 α -amino acids specified by the genetic code	
Amino acids	Structure of R moiety
Aliphatic amino acids glycine (Gly, G)	— H
alanine (Ala, A)	— CH ₃
valine (Val, V)	— CH — CH ₃ CH ₃
leucine (Leu, L)	— CH ₂ — CH — CH ₃ CH ₃
isoleucine (Ile, I)	CH ₃ — CH — CH ₂ — CH ₂
Sulfur-containing amino acids cysteine (Cys, C)	— CH ₂ — SH
methionine (Met, M)	— CH ₂ — CH ₂ — S — CH ₃
Aromatic amino acids phenylalanine (Phe, F)	— CH ₂ — 
tyrosine (Tyr, Y)	— CH ₂ — 
tryptophan (Trp, W)	— CH ₂ — 
Imino acid proline (Pro, P)	 — HN — CH — COOH (Whole structure)
Neutral amino acids serine (Ser, S)	— CH ₂ — OH
threonine (Thr, T)	— CH — OH CH ₃
asparagine (Asn, N)	— CH ₂ — CONH ₂
glutamine (Gln, Q)	— CH ₂ — CH ₂ — CONH ₂
Acidic amino acids aspartic acid (Asp, D)	— CH ₂ — COOH
glutamic acid (Glu, E)	— CH ₂ — CH ₂ — COOH
Basic amino acids histidine (His, H)	— CH ₂ — 
lysine (Lys, K)	— CH ₂ — CH ₂ — CH ₂ — CH ₂ — NH ₂
arginine (Arg, R)	— CH ₂ — CH ₂ — CH ₂ — NH — C — NH ₂ NH

1. Essential Amino Acids

Amino acids which are not synthesized in the body and must be provided in the diet to meet an animal's metabolic needs are called essential amino acids. About ten of the amino acids are grouped under this category indicating that mammals require about half of the amino acids in their diet for growth and maintenance of normal nitrogen balance.

2. Non-Essential Amino Acids

These amino acids are need not be provided through diet, because they can be biosynthesized in adequate amounts within the organism.

Essential and Non essential amino acids are as shown in the Table 5.2:

Table 5.2: Essential and Non-Essential Amino Acids

Essential Amino Acids in Mammals	Non-Essential Amino Acids in Mammals
<u>Arginine*</u> , <u>Histidine*</u> , <u>Isoleucine</u> , <u>Leucine</u> , <u>Lysine</u> , <u>Methionine</u> , <u>Phenylalanine</u> , <u>Threonine</u> , <u>Tryptophan</u> , <u>Valine</u>	<u>Alanine</u> , <u>Asparagine</u> , <u>Aspartic Acid</u> , <u>Cysteine</u> , <u>Glutamic Acid</u> , <u>Glutamine</u> , <u>Glycine</u> , <u>Proline</u> , <u>Serine</u> , <u>Tyrosine</u>

3. Semi-essential amino acids

Two amino acids are grouped under semi-essential amino acids since they can be synthesized within the organism but their synthesis is not in sufficient amounts. In that they should also be provided in the diet.

The set of essential amino acids required for each species of an organism can be an indicative of the organism propensity to minimal energetic losses on the synthesis of amino acids. Semi essential amino acids include Arginine and Histidine.

IV. Classification Based on the Fate of Each Amino acid in Mammals.

Amino acids can be classified here as Glucogenic (potentially be converted to glucose), ketogenic (potentially be converted to ketone bodies) and both glucogenic and ketogenic.

I. Glucogenic Amino Acids

Those amino acids in which their carbon skeleton gets degraded to pyruvate, α ketoglutarate, succinyl CoA, fumarate and oxaloacetate and then converted to Glucose and Glycogen, are called as Glucogenic amino acids.

These include:-

Alanine, cysteine, glycine, Arginine, glutamine, Isoleucine, tyrosine.

II. Ketogenic Amino Acids

Those amino acids in which their carbon skeleton is degraded to Acetoacetyl CoA, or acetyl CoA. then converted to acetone and β -hydroxy butyrate which are the main ketone bodies are called ketogenic amino acids.

These includes:-

Phenylalanine, tyrosine, tryptophan, isoleucine, leucine, and lysine.

These amino acids have ability to form ketone bodies which is particularly evident in untreated diabetes mellitus in which large amounts of ketone bodies are produced by the liver (i.e. not only from fatty acids but also from ketogenic amino acids)

Degradation of Leucine which is an exclusively ketogenic amino acid makes a substantial contribution to ketone bodies during starvation.

III. Ketogenic and glucogenic Amino Acids

The division between ketogenic and glucogenic amino acids is not sharp for amino acids (Tryptophan, phenylalanine, tyrosine and Isoleucine are both ketogenic and glucogenic).

Some of the amino acids that can be converted in to pyruvate, particularly (Alanine, Cysteine and serine, can also potentially form acetoacetate via acetyl CoA especially in severe starvation and untreated diabetes mellitus.

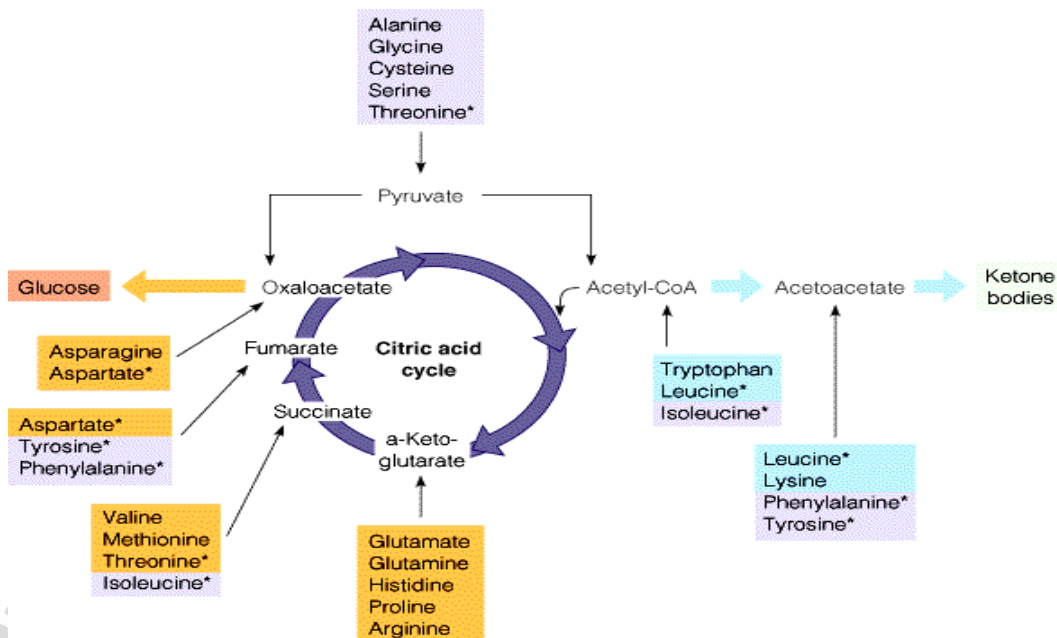

Fig 5.3. Ketogenic, Glucogenic and Glucogenic-Ketogenic amino acids

Ketogenic and Glucogenic amino acids are as indicated in the chart except Leucine and Lysine which are exclusively ketogenic.

V. Classification Based on Participation in Protein Synthesis.

I. Non-Standard Amino Acids

In addition to the 20 standard amino acids, proteins may contain non-standard (proteogenic) amino acids, which are normally components of proteins but created by modification of the standard amino acids.

Among the non – standard amino acids 4 – hydroxyproline a derivative of proline, 5-hydroxylysine derivative of lysine where both are found in collagen, a fibrous protein of connective tissues. 6 N – methyllysine a constituent of myosin, a contractile protein of muscle and γ -carboxy glutamate a derivative of glutamate, which is found in the blood clotting protein prothrombin.

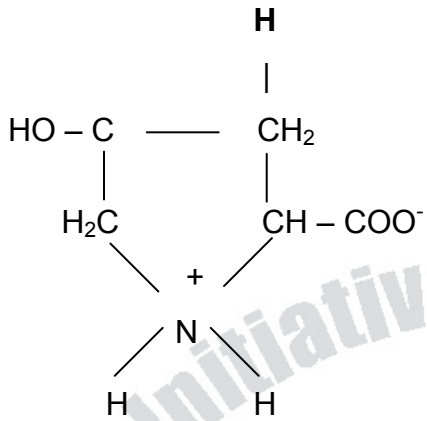

4- hydroxyproline

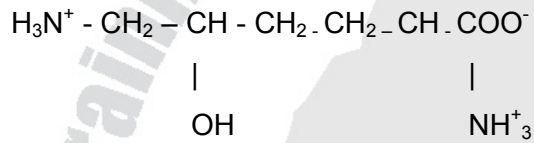

5 - hydroxylysine

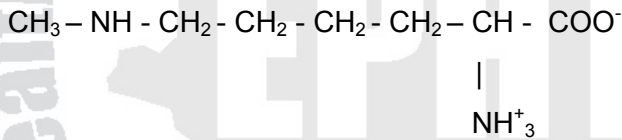

6 - N methyl Lysine

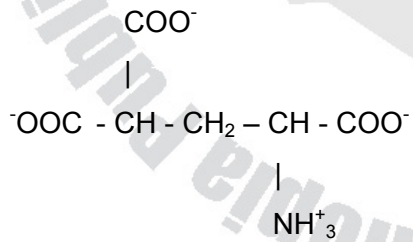

γ - Carboxyglutamate

Fig:5. 4 Non standard amino acids

II. Non – Proteogenic Amino Acids

These amino acids occur in free or combined state, unlike in proteins, and play important roles in metabolism in plasma, free amino acids are usually found in the order of 10 to 100 μ mol/L, including many that are not found in proteins.

Citrulline, for example, is an important metabolite of L. arginine and a product of Nitric - Oxide synthase, an enzyme that produces nitric oxide an important signaling molecule.

Antibiotics - gramicidin and antimycin D

γ -aminobutyric acid - which acts as an inhibitory neurotransmitter

D - Alanine - a component of vitamin, pantothenic acid, are some of the non-proteogenic amino acids.

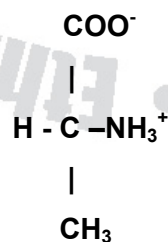
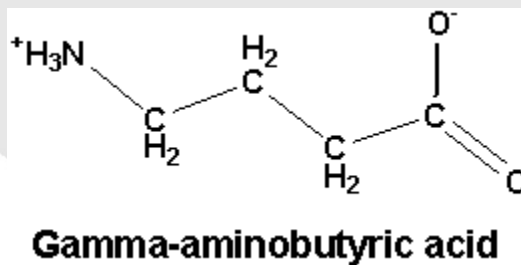
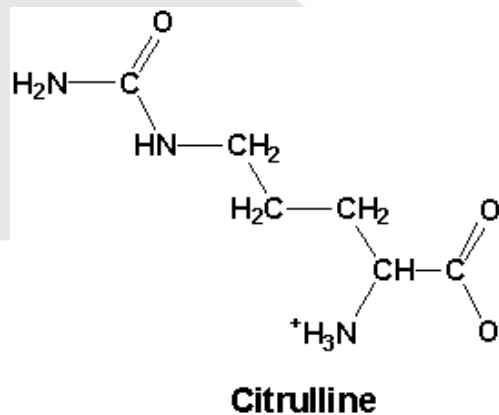

D-Alanine

PI can be calculated for Mono amine and dicarboxylic group as follows

Example:- calculate the PI of aspartic Acid (D)

$$Pka_1 \alpha - \text{carboxyl} = 2.1$$

$$Pka_2 \alpha - \text{amino} = 9.8$$

$$Pka_3 R- (\text{side chain}) \text{ or } - \text{carboxyl group} = 3.9$$

$$\text{So, } PI = \frac{Pka_1 + Pka_3}{2}$$

$$\frac{2.1+3.9}{2} = 3$$

Acid Base Properties of Amino Acids

When a crystalline amino acid, such as Alanine is dissolved in water, it can act as either an acid (proton donor) or a base (proton acceptor)

According to Laury and Bronsted theory of acid and bases, and acid is a proton donor and a base is a proton acceptor.

Example : Alanine acting as proton donor (Acid)



Alanine acting as a proton acceptor (base)

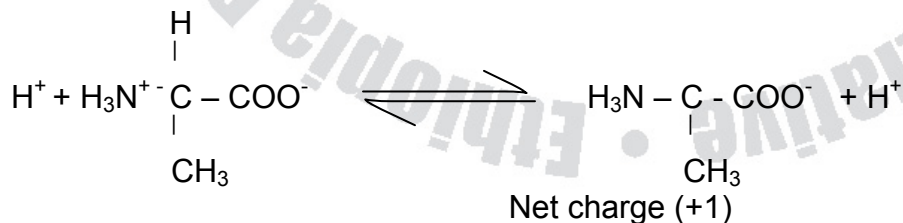

Substances having such dual nature are said to be Amphoteric and are often called Ampholytes.

Titration Curves of Amino Acids

Titration involves the gradual addition or removal of protons.

E.g. Glycine

Each molecule of added base (NaOH) to glycine results in the net removal of one proton. The titration curve plot has two distinctive stages each corresponding to the removal of one proton from glycine. Each of the two stages resembles in shape the titration curve of monoprotic acid (such as acetic acid).

At very low pH the predominant ionic species of glycine is

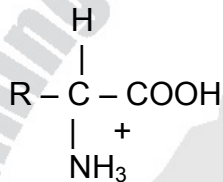

- The fully protonated form.

At the mid point in the first stages of titration in which the COOH group of glycine loses its proton where equimolar concentrations of proton donor

($\text{H}_3\text{N}^+ - \text{CH}_2 - \text{COOH}$) and proton acceptor ($\text{H}_3\text{N}^+ - \text{CH}_2 - \text{COO}^-$) species are present. At this point $\text{pH} = \text{pK}_a$ of the protonated group being titrated for Glycine. The pH at the midpoint is 2.34. Thus its COOH group has a P^{K_a} of 2.34.

As the titration proceeds another important point is reached at $\text{pH} = 5.97$. Here, there exists a point of inflection at which removal of the first proton is essentially complete and the removal of the second proton has just begun. At this point glycine exists largely as dipolar ion $\text{H}_3\text{N}^+ - \text{CH}_2 - \text{COO}^-$ (fully ionized) but with no electric charge. This characteristic pH is called as isoelectric pH designated as PI or pI.

So, for glycine, which has no ionizable group as a side chain, the isoelectric point is the Arithmetic mean of the two PK_a Values:

$$\begin{aligned} \text{PI} &= \frac{1}{2} (\text{PK}_1 + \text{pK}_2) \\ &= \frac{1}{2} (2.34 + 9.60) = 5.97 \end{aligned}$$

Glycine will have a net (-negative) charge above its PI and thus moves toward positive electrode (anode) when placed in an electric field.

At any pH below its PI, glycine has a net positive charge and moves toward negative electrode (cathode, when placed in an electric field.)

So, all amino acids with a single α - amino group and a single α - carboxyl group and an R - group that does not ionize, have titration curves resembling that of glycine.

i.e. PK_1 = (the PK of COOH group)

Usually in the range of 1.8 – 2.4

PK_2 (of the PK of $-NH_3$ group)

Usually in the range of 8.8 – 11.0

The second stage of the titration curve corresponds to the removal of a proton from the $-NH_3$ group of glycine

The pH at the midpoint of this stage is 9.60 equal to the Pka of $-NH_3^+$ group

The titration to the pH of about 12 in which the predominant form of glycine is $H_2N - CH_2 - COO^-$ (negatively charged).

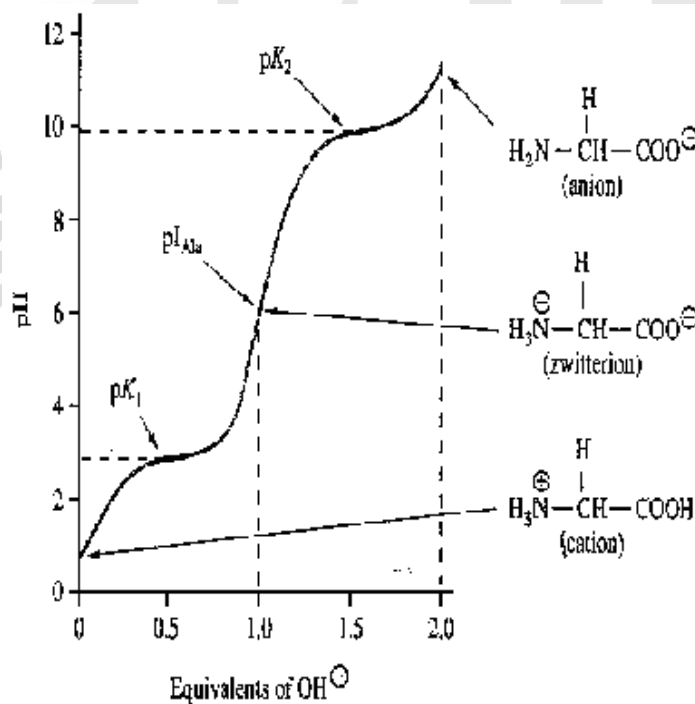

Fig 5. 6: Titration curve of Glycine

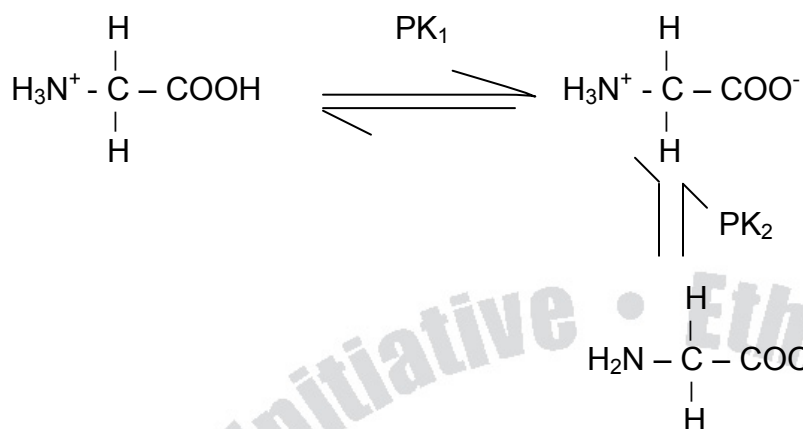
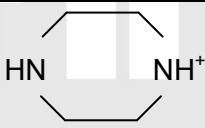
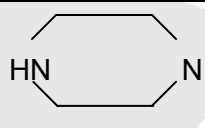
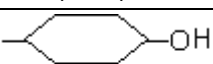
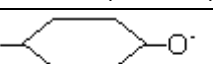
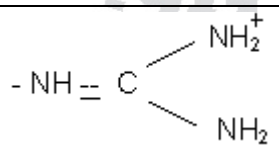
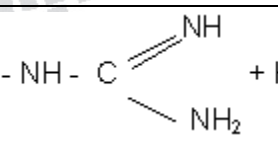

Table 5.3. Ionized groups and PK values in protein

PK values and ionized groups in proteins			
Group	Acid (conjugate acid) (protonated form)	Base + H ⁺ (conjugate base unprotonated for P ^K a)	Pka
Terminal carboxyl residue (α - carboxyl)	- COOH (carboxylic acid)	- COO ⁻ + H ⁺ (carboxylate)	3.0-5.5
Aspartic acid (β - carboxyl)	- COOH	COO ⁻ + H ⁺	3.9
Glutamic acid γ - carboxyl)	- COOH	COO ⁻ + H ⁺	4.3
Histidine (imidazole)	 (imidazolium)	 (imidazole)	6.0
Terminal amino (α - amino)	- NH ₃ ⁺ (amino)	NH ₂ + H ⁺ (amino)	8.0
Cysteine (sulfhydryl)	- SH(thiol)	- S ⁻ + H ⁺ (thiolate)	8.3
Tyrosine (phenolic – hydroxyl)	 (Phenol)	 (Phenolate)	10.1
Lysine (ε -amino)	- NH ₃ ⁺ (+ H ⁺ ε -amino)	- NH ₂ + H ⁺ (ε -amine)	10.5
Arginine (guanidine)	 guanidium	 guanidino	12.5

PKa indicates the approximate value, because it depends on temperature, buffer, etc.

Peptides

G. The peptide bond and its characteristics

Proteins are macromolecules with a backbone formed by polymerization of amino acids in a polyamide structure. These amide bonds in protein, known as peptide bonds formed by linkage of α - carboxyl group of one amino acid with α - amino groups of the next amino acid by amide bonds.

During the formation of a peptide bond, a molecule of water is eliminated as shown below:-

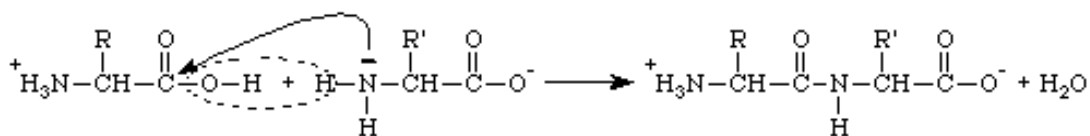

Fig 5.7: Peptide bond synthesis

A peptide chain consisting of two amino acid residues is called a dipeptide, three amino acids tripeptide (e. g Glutathione) etc.

E.g. A tripeptide formed from Cysteine, Glycine and Alanine.

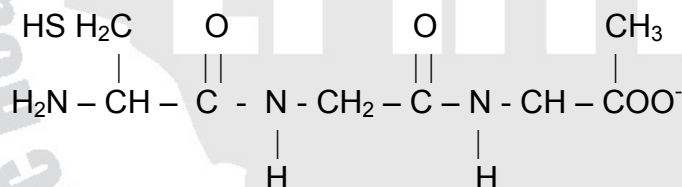

Fig 5.8: A tripeptide

By convention, peptide structures are written with amino terminal residues on the left and with the carboxyl terminal residue at the right.

In peptides, the amino acids are joined covalently through peptide bonds, and are formed on partial hydrolysis of much longer polypeptides. Note that the C=O and the NH – bonds are nearly parallel and that the C, O, N, and H are usually co-planar. The C - N single bond in the peptide linkage has ~ 40% double bond character and C = O double bond has ~ 40% single bond character. This has two important consequences.

1. The imino group (-NH-) of the peptide linkage has no significant tendency to ionize or protonate in the pH range 0 – 14
2. The C - N of a peptide linkage is relatively rigid and cannot rotate freely, a property of supreme importance with respect to the three dimensional conformation of polypeptide chains.

In amide linkage of the peptide bond due to the substantial double bond character there exists little twisting. As a result the group of atoms in the peptide bond exist in the cis or trans nature of the peptide bond. It was found out that the trans configuration is usually favored in order to minimize the steric interaction between bulky R groups on adjacent α -carbon atoms. One exception is bonds in the sequence X – Pro, which X is any amino acid followed by Proline. In this case Cis configuration may be favored.

In fact, the **peptide bond** can be considered a resonance hybrid of the forms

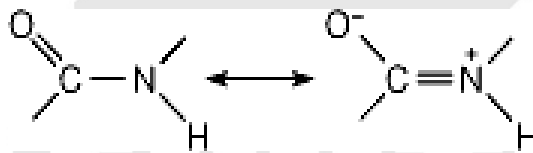

Fig 5.9: A peptide bond

The group of atoms about the peptide bond can exist in either the **trans** or **cis** configurations:

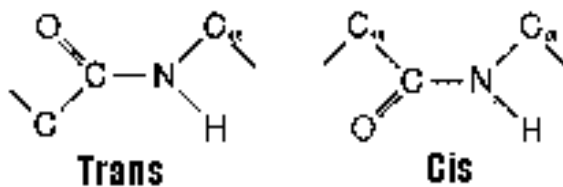

Fig 5.10: Tran and cis conformation of peptide bonds

Peptides of Physiological Significance

Glutathione

Glutathione is a tripeptide formed from amino acids glutamate, cysteine and Glycine, linked together in that order. The glutamate is linked to cysteine through the γ - carboxyl group and α - amino group of cysteine.

Here, the carboxyl group is first activated by ATP to form an acyl-phosphate derivative which is then attacked by cysteine amino group then undergoes condensation with glycine.

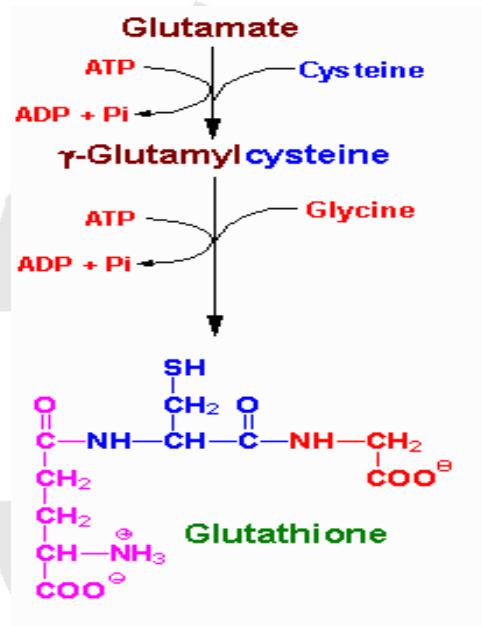

Fig 5.11: Glutathione Synthesis

The role of GSH as a reductant is extremely important particularly in the highly oxidizing environment of the erythrocyte. The sulfhydryl of GSH can be used to reduce peroxides formed during oxygen transport. The resulting oxidized form of GSH consists of two molecules disulfide bonded together (abbreviated GSSG). The enzyme **glutathione reductase** utilizes NADPH as a cofactor to reduce GSSG back to two moles of GSH. Hence, the pentose phosphate pathway is an extremely important pathway of erythrocytes for the continuing production of the NADPH needed by **glutathione reductase**. In fact as much as 10% of glucose consumption, by erythrocytes, may be mediated by the pentose phosphate pathway.

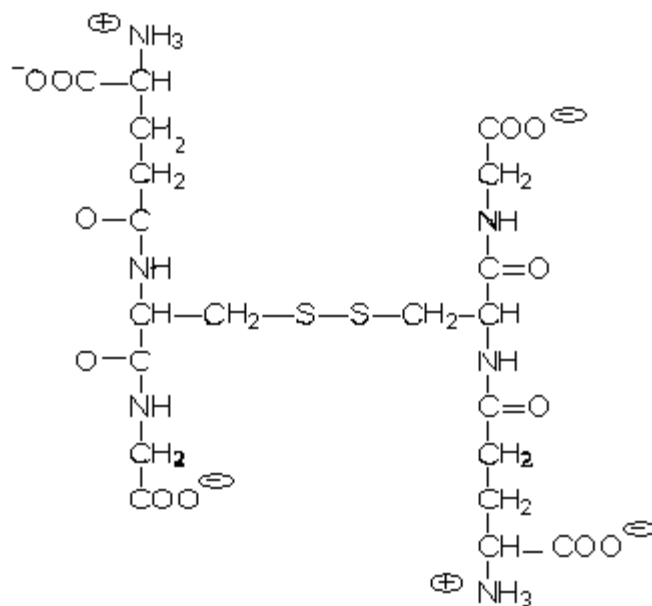
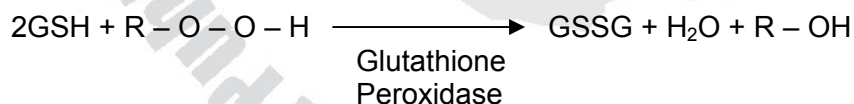

Fig5. 12. **Structure of GSSG (Glutathione disulphide).**

Glutathione is virtually present in all cells often at high levels and can be thought as a kind of redox buffer, which probably helps to maintain.

- 1) Sulfhydryl groups of proteins in the reduced state
- 2) Keeps the iron of heme in the ferrous (Fe^{2+}) state
- 3) Serves as a reducing agent for glutaredoxin.

With its redox function it can also be used to remove toxic peroxides that are formed in the course of growth and metabolism under aerobic condition.



Glutathione peroxidase is a remarkable enzyme that contain a covalently bound selenium (Se) atom in the form of selenocysteine.

Conjugation of drugs by glutathione is often a preliminary reaction catalyzed by cytochrome P_{450} , rendering substances to be more polar and assist their excretion as shown in the figure 5.13.

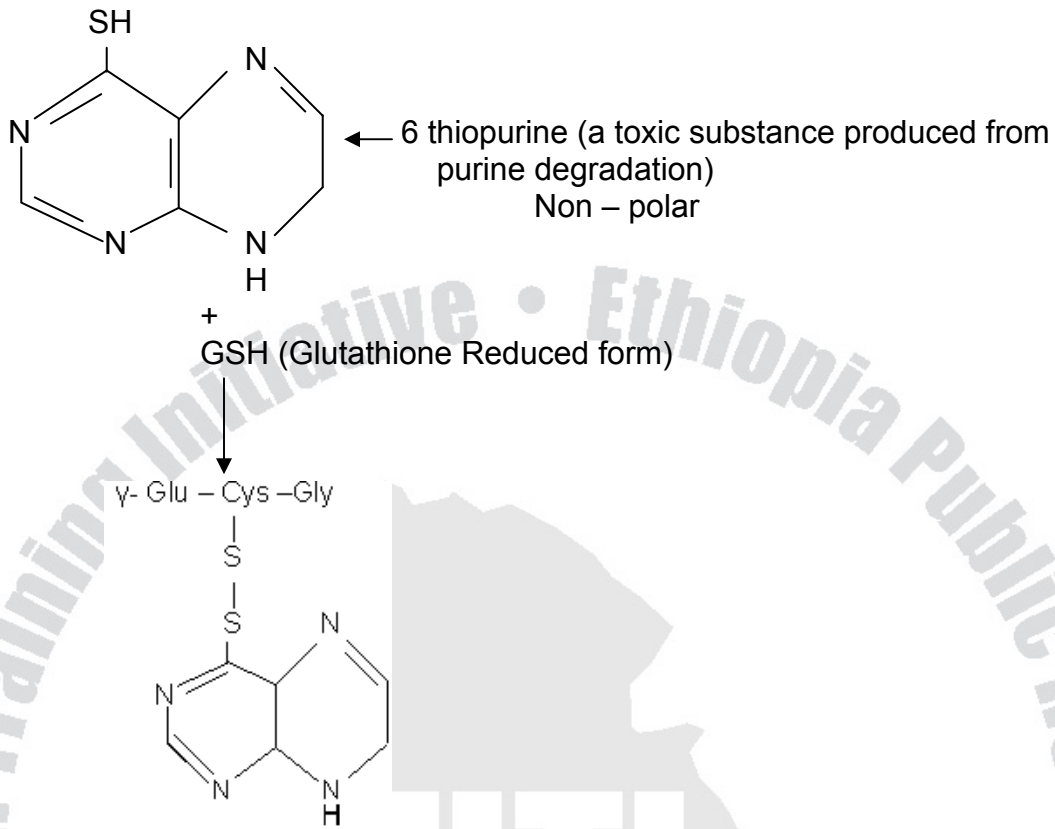

6 thiopurine (more polar and can be excreted out of the body easily)

Fig 5.13: Transformation of 6-thio purine in to a non toxic form

b) Scavenging of peroxides by glutathione peroxidase.

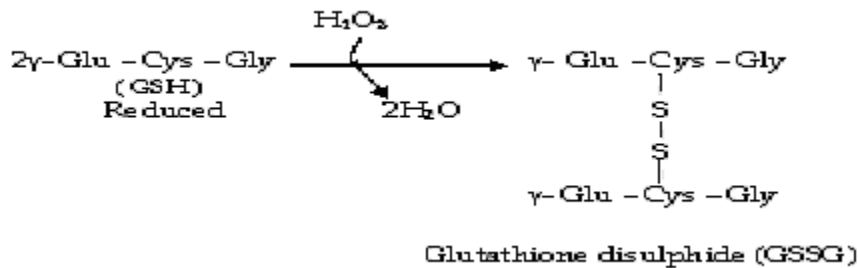
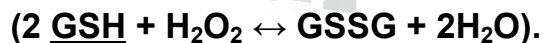

Fig 5.14: Role of Glutathione in scavenging Peroxides or



* Other peptides having physiological role include:

- Enkephalin (penta peptide)
- Bradykinin (nano peptide)
- Antidiuretic hormone (ADH) (nano peptide), etc.

PROTEINS

The word protein is derived from Greek word, proteious meaning primary. So, proteins are the major components of any living organism.

Proteins are natural substances with high molecular weights ranging from 5,000 to many millions. Besides Carbon, Hydrogen and Oxygen, they also contain Nitrogen, and sometimes, Sulfur and Phosphorous.

Proteins are most important constituent of cell membranes and cytoplasm. Muscle and blood plasma also contain certain specific proteins.

Protein containing foods are essential for living organism, because protein is the most important biological molecules in building up and maintenances of the structure of body, giving as much energy as carbohydrates in the course of metabolism in the body. Many of the body proteins perform innumerable chemical reactions constantly taking place inside the body.

Proteins are the molecular instruments in which genetic information is expressed; hormones, antibodies, transporters, muscle, the lense protein, antibiotics, mushroom poisons, and a myriad of other substances having distinct biological activities are derived.

Definition

Proteins are macromolecules with a backbone formed by polymerization of amino acids in a polyamide structure.

Classification

Even though there is no universally accepted classification system, proteins may be classified on the basis of their composition, solubility, shape, biological function and on their three dimensional structure.

I. Composition:-

A. Simple protein:

Yields only amino acids and no other major organic or inorganic hydrolysis products i.e. most of the elemental compositions.

B. Conjugated Proteins

Yields amino acids and other organic and inorganic components

E.g. Nucleoprotein	(a protein containing Nuclei acids)
Lipoprotein	(a protein containing lipids)
Phosphoprotein	(a protein containing phosphorous)
Metalloprotein	(a protein containing metal ions of Fe^{2+})
Glycoprotein	(a protein containing carbohydrates)

II. Solubility

- Albumins: These proteins such as egg albumin and serum albumin are readily soluble in water and coagulated by heat.
- Globulins: these proteins are present in serum, muscle and other tissues and are soluble in dilute salt solution but sparingly in water.
- Histones:
Histones are present in glandular tissues (thymus, pancreas etc.) soluble in water; they combine with nucleic acids in cells and on hydrolysis yield basic amino acids

III. Overall Shape

A. Fibrous proteins

In these protein, the molecule are constituted by several coiled cross-linked polypeptide chains, they are insoluble in water and highly resistant to enzyme digestion. The ratio of length to breadth (axial ratio) is more than 10 in such protein. A few sub groups are listed below.

- Collagens: the major protein of the connective tissue, insoluble in water, acids or alkalis. But they are convertible to water-soluble gelatin, easily digestible by enzymes.
- Elastins: present in tendons, arteries and other elastic tissues, not convertible to gelatin.
- Keratins: protein of hair, nails etc.

B. Globular proteins: These are globular or ovoid in shape, soluble in water and constitute the enzymes, oxygen carrying proteins, hormones etc. the axial ratio is 3 to 4 or less. Subclasses include:- Albumin, globulins and histones.

IV. On their Biological Functions:

Proteins are sometimes described as the "workhorses" of the cell because they do

So many things Like:

Enzymes:	kinases, transaminases etc.
Storage proteins	myoglobin, ferritin
Regulatory proteins	peptide hormones, DNA binding proteins
Structural protein	collagen, proteoglycan
Protective proteins	blood clotting factors, Immunoglobins,
Transport protein	Hemoglobin, plasma lipoproteins
Contractile or motile Proteins	Actin, tubulin

V. On their level of organization

Primary, secondary, tertiary and quaternary.

a) Primary Structure of Proteins

The primary structure of a protein is defined by the linear sequences of amino acid residues. Protein contain between 50 and 2000 amino acid residues.

The mean molecular mass of an amino acid residue is about 110 Dalton units (Da).

Therefore the molecular mass of most proteins is between 5500 and 220,000 Da.

The amino acid composition of a peptide chain has a profound effect on its physical and chemical properties of proteins.

Protein rich in polar amino acids are more water soluble. Proteins rich in aliphatic or aromatic amino groups are relatively insoluble in water and more soluble in cell membranes (can easily cross the cell membrane).

- The primary structure cannot represent the 3D-nature of a protein molecule since the extended chain of amino acids is co-planar as the covalent bond of peptide is right.

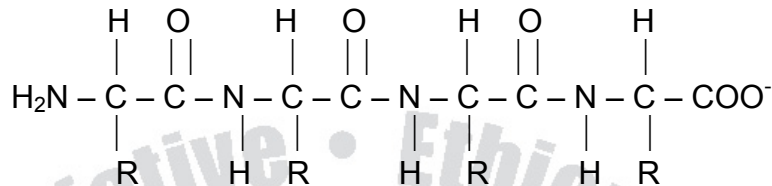

Fig 5. 15: The primary structure of a protein

b) Secondary Structure

The secondary structure of a protein refers to the local structure of a polypeptide chain, which is determined by Hydrogen bond. The Interactions are between the carbonyl oxygen group of one peptide bond and the amide hydrogen of another near by peptide bond.

There are two types of secondary structure, the α - helix and the β - pleated sheet.

The α - helix

The α - helix is a rod like structure with peptide chains tightly coiled and the side chains of amino acid residues extending outward from the axis of spiral. Each amide carbonyl group is hydrogen bonded to the amide hydrogen of a peptide bond that is 4 - residues away along the same chain. There are 3.6 amino acids residues per turn of the helix the complete turn has 0.54 mm pitch. ($1\text{nm} = 10^{-9}\text{ m}$) including nearly 3.6 amino acid residues. This enable every = NH group to bind with a carbonyl O, fourth in line behind the primary structure and the helix winds in a right handed manner in almost all natural protein, i.e. turns in a clockwise fashion around the axis.

Since all the carbonyl oxygen and peptide nitrogen are thus involved in the hydrogen bonds, the hydrophilic nature of the helical region is greatly minimized. As the free energy involved in hydrogen bond is very low, it is formed spontanemsly being weak bonds these are disrupted easily when the chain is extended by a little force and reformed when force is released.

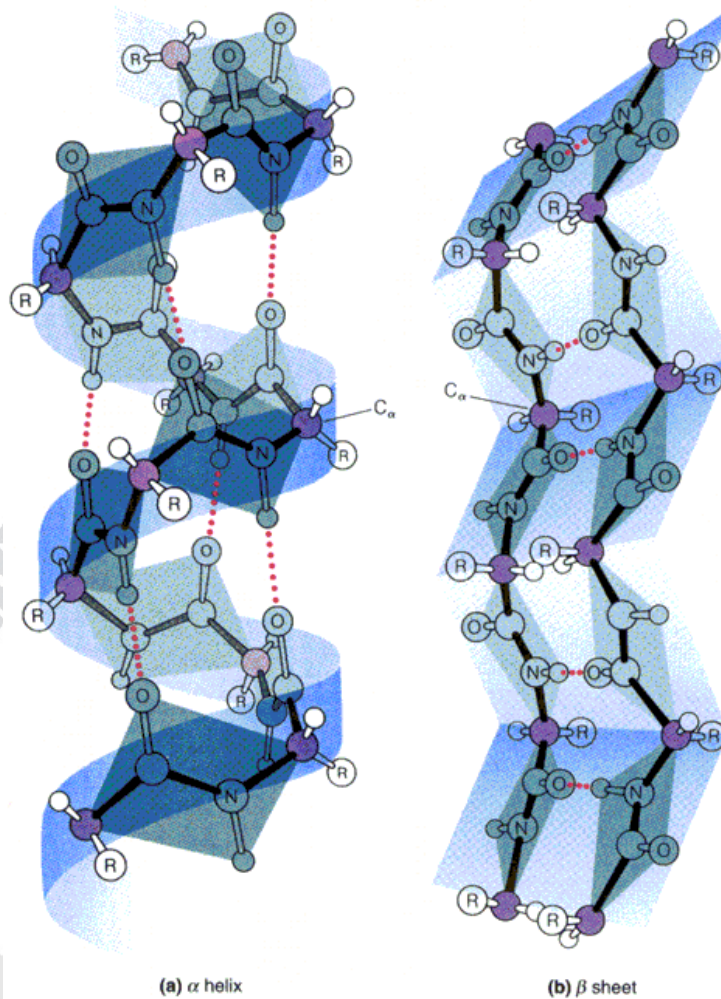

Fig 5.16. The α helix (a) and the β -pleated sheet (b)

c) Tertiary Structure

The three dimensional, folded and biologically active conformation of a protein is referred to as tertiary structure. The structure reflects the overall shape of the molecule. The three - dimensional tertiary structure of a protein is stabilized by interactions between side. Chain functional group, covalent, disulfide bonds, hydrogen bonds, salt bridges, and hydrophobic interactions.

In the tertiary structure the side chains of Tryptophan and Arginine serve as both hydrogen bond donors and acceptors. Lysine, aspartic acid Glutamic acid, tyrosine and Histidine also can serve as both donors and acceptors in the formation of ion-pairs (salt bridges). Two opposite - charged amino acids, such as glutamate with a γ -carboxyl group and lysine with an ϵ - amino group, may form a salt bridge, primarily on the surface of proteins.

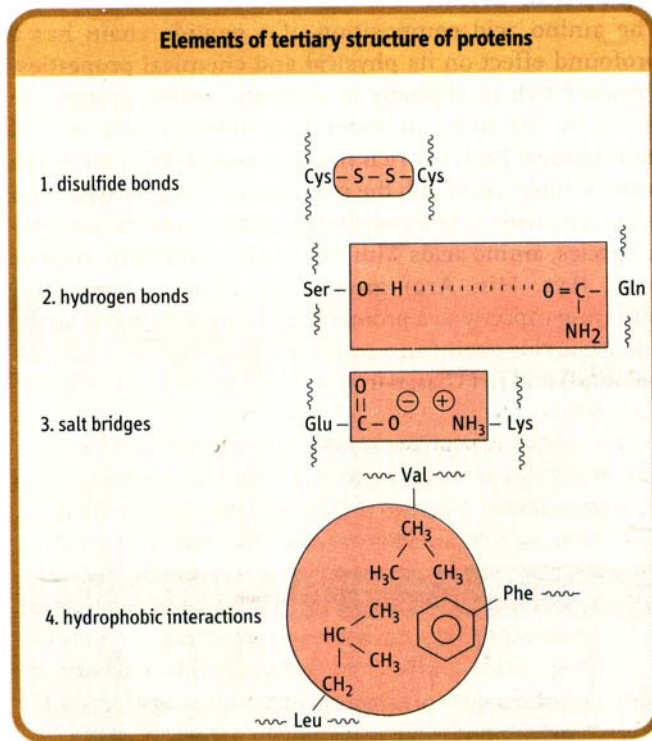

Fig.5.17. Elements that stabilize the tertiary structure of a protein

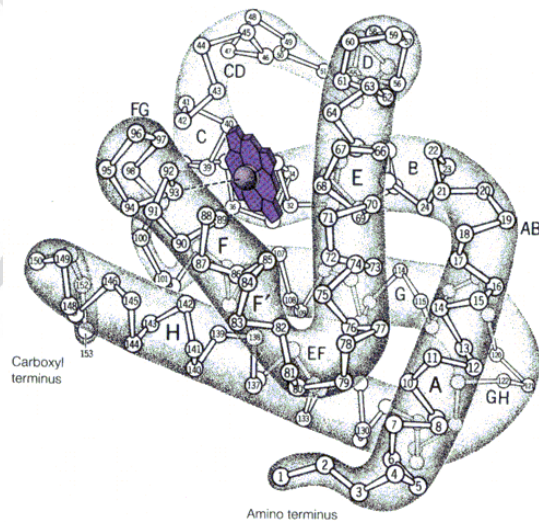

Fig 5.18. The three dimensional structure of Myoglobin

d) Quaternary Structure

Quaternary structure refers to a complex or an assembly of two or more separate peptide chains that are held together by non-covalent or, in some case, covalent interactions.

If the subunits are identical, it is a homogeneous quaternary structure; but if there are dissimilarities, it is heterogeneous. For instance insulin consists of A and B chain which are different. Hemoglobin has 4 chains, two of them are α and two are β . these, the polymers may be dimers, trimers, tetramers and so on.

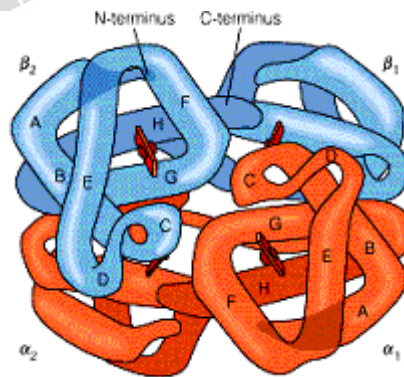

Fig 5.19: Hemoglobin as an example of tertiary structure of a protein

Hemoglobin structure shown above is as an example of quaternary structure of a Protein. Cu, Zn - superoxide dismutase from spinach is a good example of quaternary structure of a protein.

The β -pleated sheet

The β - pleated sheet is an extended structure as opposed the coiled α - helix. It is pleated because the (C-C) bonds are tetrahedral and cannot exist in a planar configuration. If the polypeptide chain runs in the same direction, it forms a parallel β - sheet. It is said to be parallel, and when in opposite direction, antiparallel. A protein molecule may have both type of secondary configuration in different parts of its molecule. Glycine (Gly) and proline (Pro) residues often occur in β -turns on the surface of globular proteins. Most immunoglobulins have such β -pleated conformation and some enzymes like Hexokinase contain a mixed α - β conformation.

Diagrammatic representation of hydrogen bonds between -NH and C=O groups on adjacent strands in a β -pleated sheet is as shown above in the Fig 5.16.

Denaturation of Proteins

Proteins have finite lifetimes. They are also subject to environmental damages like oxidation proteolysis, denaturation and other irreversible modifications.

Denaturation involves the destruction of the higher level structural organization (2^0 , 3^0 and 4^0) of protein with the retention of the primary structure by denaturing agents.

A denatured protein loses its native physico-chemical and biological properties since the bonds that stabilize the protein are broken down. Thus the polypeptide chain unfolds itself and remain in solution in the unfolded state. The denatured protein may retain its biological activity by refolding (renaturing) when the denaturing agent is removed.

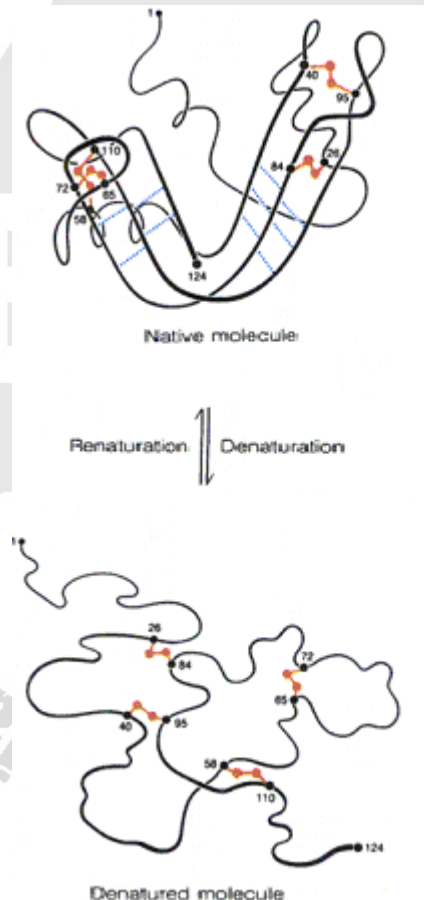

Fig 5.20: Denaturation of proteins

Factors that Affect Denaturation

Denaturing agents

1. physical factors

Temperature, pressure, mechanical shear force, ultrasonic vibration and ionizing radiation causes the protein to lose its biological activity.

2. chemical factors

Acids and alkalis, organic solvents (acetone, ethanol), detergents (cleaning agents), certain amides urea, guanidine hydrochloride, alkaloids, and heavy metal salts (Hg, Cu, Ba, Zn, Cd...) Cause the denaturation.

Properties of a Denatured Protein

- A. an increase in number of reactive and functional group in the composition of the native protein molecule (side chain group of amino acids, COOH, NH₂, SH, OH ... etc)
- B. Reduced solubility and pronounced propensity for precipitation
this occurs due to loss of the hydration shell and the unfolding of protein molecules with concomitant exposure of hydrophobic radicals and neutralization of charged polar groups.
- C. Configurational alteration of the protein molecule.
- D. Loss of biological activity evoked by the disarrangement of the native structural molecular organization.
- E. Access of proteolytic enzymes in comparison with the native protein

Clinical Application of Denaturation

The amounts of proteins found in the urine, serum, CSF are utilized to assess various pathological conditions. The appearance of proteins like Albumin and Globulin in the urine can be detected by precipitating them using ammonium sulphate. This could be used to assess the degree of kidney impairment and glomerular permeability.

In some disease, abnormal proteins may be present in plasma and be filtered at the glomerule. The most important member is Bence-jons' protein which is most often associated with multiple myeloma. So recognition of such protein in the urine may be useful in the diagnosis of the disease.

This could be done by treating few ml of urine with few ml of hydrochloric acid giving a white ring at the junction of the two fluids.

In the case of CSF protein estimation and analysis, a saturated phenol solution is used where 2 drops of CSF with 2ml of 10gm phenol dissolved in distilled water to check for turbidity. If the

turbidity increases indicates an increase in Globulins. An increase in γ -globulins is observed in case of multiple sclerosis and Neurosyphilis.

The normal level of Albumin in the CSF is 25-30mg%. When CSF treated with sulphosalisalic acid with equal amounts and turbidity increases indicating an increase in the concentration of Albumin in the CSF may be attributed to Acute meningities (usually about 35-40mg% when measured spectrometrically).

Usually the level doesn't exceed 1gm/L. only in the case of Multiple scleroma and spinal block 10gm/l might be observed.

Hemoglobin

Humans are aerobic organisms. Their lungs extract (O_2) from inhaled gases.

The inspired (O_2) leads to a more efficient utilization of fatty acids. Where as the expired CO_2 is a major product of cellular metabolism.

Living systems contain protein that interact with O_2 and consequently increase its solubility in H_2O and sequester it for further reaction.

In mammals, Myoglobin (Mb) is found primarily in skeletal and striated muscle which mainly serves as a store of O_2 in the cytoplasm and deliver it on demand to the mitochondria.

Where as, Hemoglobin (Hb) is restricted to the Erythrocytes which is responsible for the movement of O_2 between lungs and other tissues .

Structure of the Heme Prosthetic Group

Heme is the O_2 – binding molecule common to Mb and Hb protophorphyrin IX is the backbone of heme when iron is complexed with protophorphyrin IX it is called Heme. So heme is the prosthetic group in Hemoglobin, Myoglobin and Cytochrome b, c, and c_1 .

The Fe – porphyrin prosthetic group is, with the exception of two propionate groups, hydrophobic and planar.

Heme become an integral part of the globin proteins during poly peptide synthesis. It is the heme molecule that give globin proteins their characteristic red brown colour. Once the Fe^{2+} (Ferrious) is incorporated, the protein is called hemoglobin. Such structural coordination creates an environment essential for Globin to bind and release O_2 .

If the iron atom were to become oxidized to Fe^{3+} (Ferric), the Globin would get changed to metmyoglobin or (Met hemoglobin) where heme can no longer interact with O_2 and O_2 transport is compromised.

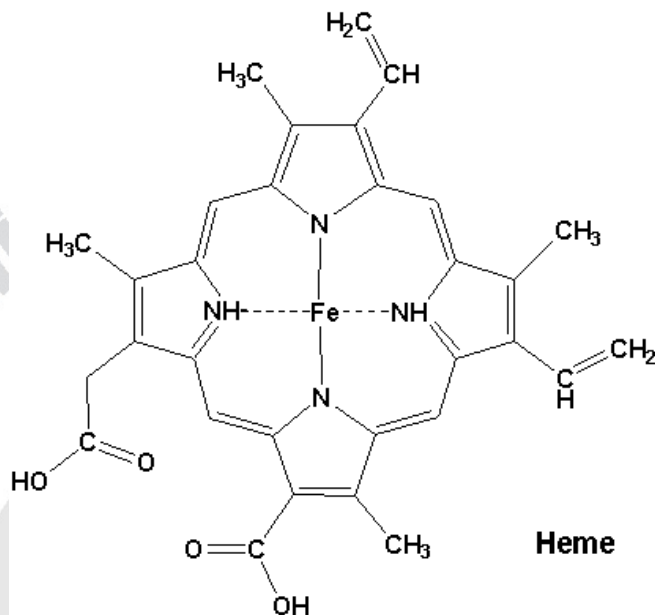

Fig 5.21: Structure of the heme prosthetic group (protoporphyrin IX) ring system.

Heme is non-covalently bonded in a hydrophobic crevice in the myoglobin and hemoglobin molecules.

Ferrous iron is octahedrally coordinated having six ligands or binding groups, attached to it, the nitrogen atoms account for only four ligands. The two remaining coordination sites which lie along the ring contain on the plane of the ring contains one histidine with imidazole nitrogen that is close enough to bond directly to the Fe^{2+} called proximal histidine the other histidine which facilitates the alignment of heme to O_2 and that of Fe^{2+} called distal Histidine. Distal histidine confers important geometrical constraints on the six coordination sites which normally restricts the interaction with CO.

The coordinate nitrogen atoms mainly prevents conversion of the heme iron to the ferric state (Fe^{3+}) due to their electron donating character.

In free heme molecules, reaction of oxygen at one of the two "open" coordination bonds of iron which is perpendicular to the plane of the porphyrin molecule above and below can result in irreversible conversion of Fe^{2+} to Fe^{3+} . In heme containing proteins this reaction is prevented by

sequestering the heme deep within a protein structure where access to the two open coordination bonds is restricted polar amino acids are located almost exclusively on the exterior surface of globin polypeptide and contribute to the high solubility of these proteins. Amino acids which are both polar and hydrophobic, such as Threonine, tyrosine and Tryptophan are oriented to the exterior.

Hydrophobic amino acid residues are buried with in the interior where they stabilize the folding of the polypeptide and binding of iron porphyrin ring.

The only exceptions to this general distribution of amino acids residues in globins are the two Histidines that play an indispensable role in the heme binding are oriented perpendicular to and on either side of the planar heme prosthetic group.

In the quaternary structure of human Hb there exists two α - globin and two β - globin sub units ($\alpha_2 \beta_2$). These subunits are arranged in a tetrahedral array. Experimental analysis of the quaternary structure indicates multiple non-covalent interactions between each pair of dissimilar subunits, that is, at the $\alpha - \beta$ - interfaces. In contrast there are few interactions between identical subunits at the $\alpha - \alpha$ or $\beta - \beta$ interface so hemoglobin is considered more as a heterodimer ($\alpha \beta$)₂. The $\alpha \beta$ -heterodimer are now recognized as major factors determiners of O₂ binding and release.

Myoglobin and Hemoglobin

Both Myoglobin and Hemoglobin are built on a common structural motif. **Myoglobin** contains a single polypeptide chain folded about a prosthetic group, the heme, which contains the oxygen binding site. **Hemoglobin** is a tetrameric protein. Each polypeptide subunit closely resembles **myoglobin**. Note, for example that myoglobin and each subunit of hemoglobin consists of eight helical segments, which are labeled A through H. The multiple subunit structure of **hemoglobin** gives it important oxygen binding properties that are different than **myoglobin's**, consistent with **hemoglobin's** role in oxygen transport. In all vertebrates the oxygen transport protein is **hemoglobin**, a protein that can pick up oxygen in lungs or gills and deliver it to tissues. **Myoglobin**, by contrast, is an oxygen storage protein. Oxygen transported to tissues must be released for utilization. In tissues, such as muscle, with high oxygen demands, **myoglobin** provides large oxygen reserves.

Adult Hb (HbA)

Contains two types of globin two α - chains (141 residues each) and two β - chains (146 residue each). The amino acid sequences of the two type of subunits are identical at 27 positions.

Fetal Hb (HbF)

Contains a different type of Hb just after conception fetuses synthesize zeta chain (quite like α - chain)

The HbF variant barely detectable and ϵ - chains just like β - chain later zeta replaced by α - and ϵ - by γ . HbF contain 2 γ and 2 γ subunits in most adult often increases up to 15 - 20% in individuals with mutant adult Hbs, such as sickle cell disease. This is an example of the body's compensatory response to a pathologic abnormality .The direct benefit of this structural change in Hb isoform is a more efficient transfer of O_2 from maternal HbA to fetal(HbF) .

Sickle Cell Hemoglobin (HbS)

HbS, the variant most commonly associated with sickle cell disease, cannot tolerate high protein concentration when deoxygenated. At low oxygen concentrations, deoxy HbS polymerizes, forms fibers, and distorts erythrocytes in to sickle shapes.

The mutation is $Glu^6 \beta$ -val a surface localized charged amino acids is replaced by a hydrophobic residue as show below

HbA = Val – His – Leu – Thr – Pro – Glu – Glu – Lys

HbS = Val – His – Leu – Thr – Pro – Val – Glu – Lys

Such substitution of Valine (non - polar) for Glutamate (polar) have the following consequence

1. Place A non - polar residue on the outside of HbS which markedly reduce solubility of deoxy HbS. But has little effect on oxy - HbS (causes Hb to clump when deoxygenated)
2. Creates sticky patches on the outside surface of each β - chains (not present HbA)
3. The sticky patches interact with complementary sites of another HbS (oxy) and forms large aggregates that distort the whole RBC structure.

Sickle Cell Trait

The heterozygote individuals (sickle cell trait) (HbA/HbS) is associated with increased resistance to malaria. Specifically growth of the infectious agent, Plasmodium falciparum in the erythrocyte.

This observation represents an example of a selective advantage that HbA/ HbS heterozygote exhibits over the HbA/HbA normal or the HbS/HbS homozygote.

Sickled erythrocyte exhibits little or less deformity, they no longer move freely through the microvasculature and often block blood flow. Moreover these cells lose water, become fragile and have a considerably short life span leading to anemia.

Sickle Cell Disease

Sickle cell disease is caused by an inherited structural abnormality in the β -globin polypeptide. Clinically, an individual with sickle cell disease presents with intermittent episodes of haemolytic and painful vaso-occlusive crisis. The latter leading to severe pain in the bone, chest and abdomen. There is also a likely to be impaired growth, increased susceptibility to infections and multiple organ damage.

Digestion and Absorption of Proteins

Proteins are larger polypeptide molecules coiled by weaker bonds in their tertiary structure. The digestion of proteins involves the gradual breakdown of this polypeptide by enzymatic hydrolysis into amino acid molecules which are absorbed in the blood stream. The protein load received by the gut is derived from two sources: 70-100g dietary protein which is required daily and 35 - 200g endogenous protein (secreted enzymes and proteins in the gut or from intestinal epithelial cell turnover).

Only 1-2g of nitrogen equivalent to 6-12g of proteins are lost in the feces on a daily basis. Thus the digestion and absorption of protein is more efficient.

The process of protein digestion can be divided, depending on the sources of peptidases.

A. Gastric Digestion

Entry of a protein into the stomach stimulates the gastric mucosa to secrete a hormone gastrin which in turn stimulates the secretion of HCl by the parietal cells of the gastric glands and pepsinogen by the chief cells.

The HCl thus produced lowers the pH of the stomach to (pH 1.5 – 2.5) and acts as an antiseptic and kills most of the bacteria and other foreign cells ingested along with it.

The acid denatures the protein and the whole protein is susceptible to hydrolysis by the action of other proteolytic enzymes.

Proteases are endopeptidases which attack the internal bonds and liberate large fragments of peptides.

Then pepsinogen having MW 40,000 an inactive precursor or zymogen is converted in to active pepsin in the stomach itself. In this process 44 amino acids gets removed from the amino terminal end and the portion of the molecule that remain intact is enzymatically active pepsin (MW. 33,000).

This active pepsin cleaves the ingested protein at their amino terminus of aromatic amino acids (Phe, Tyr, and Trp.)

The major products of pepsin action are large peptide fragments and some free amino acids.

B. Pancreatic Digestion

Pancreatic zymogens proceed digestion as the acidic stomach contents pass in to the small intestine, A low pH triggers the secretion of a hormone Secretin in the blood.

Secretin stimulates the pancreas to secrete HCO_3^- (bicarbonate), which in the small intestine neutralizes the gastric HCL and abruptly change the pH to 7.0.

The entry of large peptide fragments and some free amino acids in the upper part of the small intestine (Duodenum), excites the release of a hormone cholecystokinin (CCK).

CCK:

- 1) stimulates gall bladder contraction.
- 2) stimulate secretion of several pancreatic enzymes whose activity is between pH 7 and 8 in proenzyme forms.

Three of these pro-enzyme are trypsinogen, chymotrypsinogen and procarboxy peptidase, localized in the exocrine cells. Synthesis of these enzymes as inactive precursors protects the exocrine cells from destructive proteolytic attack.

When the proenzyme reach the lumen of the small intestine, initially the enteropeptidase (old name Enterokinase) a protease produced by duodenal epithelial cells, activates pancreatic trypsinogen to trypsin by the removal of a hexapeptide from NH_2 – terminus

Trypsin in turn auto catalytically activates more trypsinogen to trypsin and other proenzymes and liberating chymotrypsin elastase, and carboxypeptidase's

A and B as shown below.

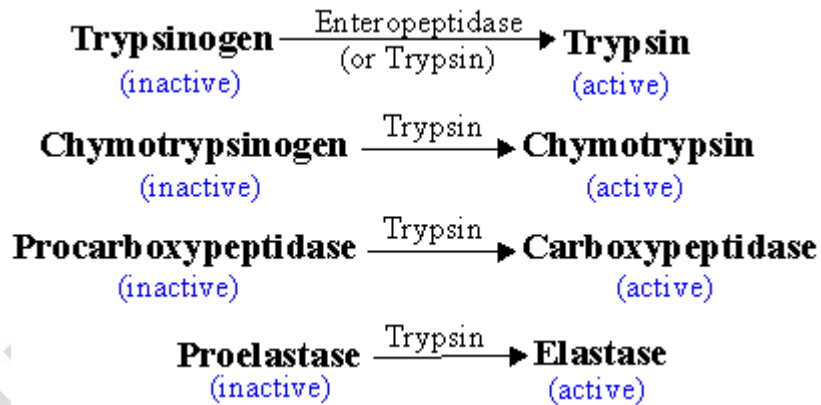

By the sequential action of these proteolytic enzymes and peptides ingested proteins are hydrolyzed to yield a mixture of free amino acids which can be transported across the epithelial lining of the small intestine.

ENZYME	SPECIFICITY
Trypsin	Basic amino acids (Arg, Lys)
Chymotrypsin	Aromatic amino acids (Phe, Trp, Tyr)
Carboxypeptidase A	Most C-terminal amino acids
Carboxypeptidase B	C-terminal Arg and Lys
Elastase	Ala, Gly, Ser

Table 5.4: Digestive enzymes and their specificity

C. Intestinal Digestion

Since pancreatic juice does not contain appreciable aminopeptidase activity final digestion of di and Oligopeptides depends on the small intestinal enzymes.

The luminal surface of epithelial cells is rich in endopeptidase, and dipeptidase aminopeptidase activity

The end products of the cell surface digestion are free amino acids and di and tripeptides.

These are passed in to the interior of the epithelial cell where other specific peptidases convert almost all of them to a single amino acids that are transported to the blood stream by the opposite side of the cell membrane and carried to liver (primarily) and other tissues for oxidative degradation. This process complete the absorption of 99% of digested proteins. The whole scheme is as shown in the figure below.

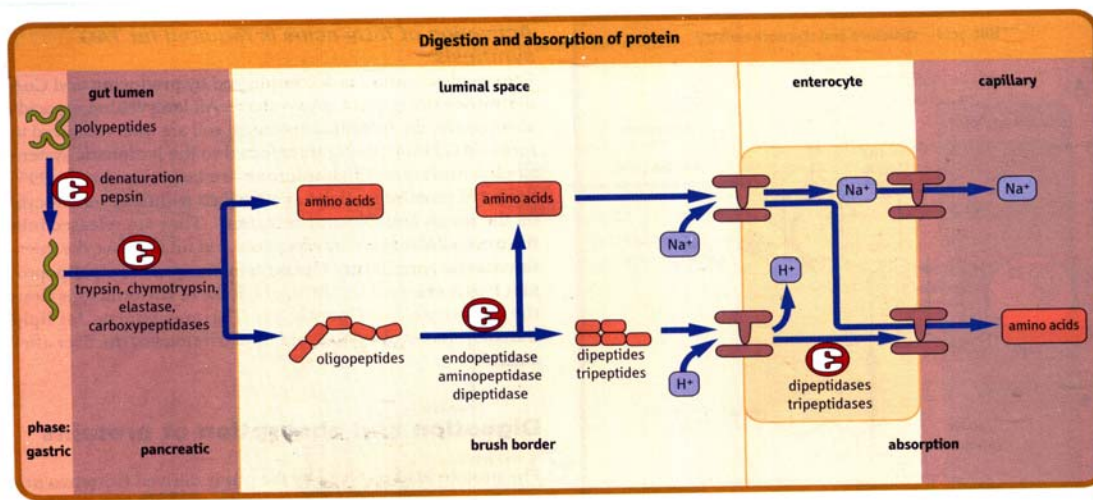

Fig 5.22: Digestion and absorption of proteins

II. Transport of Amino Acids in to Intestinal Epithelial cells.

The mechanism of active transport of amino acids are similar with that of glucose uptake.

At the brush - border membrane Na⁺ - dependent symporters for amino acid uptake are functional with consequent ATP - linked pumping out Na⁺ at the contraluminal membrane. This is an indirect active transport.

A similar H⁺ dependent symport is present on the brush border surface of di and tripeptides active transport in to the cell.

Na⁺ - independent transporters are present on the contraluminal surface, thus allowing amino acids? Facilitated transport to the hepatic portal system.

From both genetic and transporters studies at least six specific symporter systems have been identified for the uptake of L-amino acids from the intestinal lumen.

1. Neutral amino acid symporters with short or polar side chains.

Ser, Thr, Ala,

called as aminotransferases. Most of the amino acids undergo these reaction except lysine and threonine

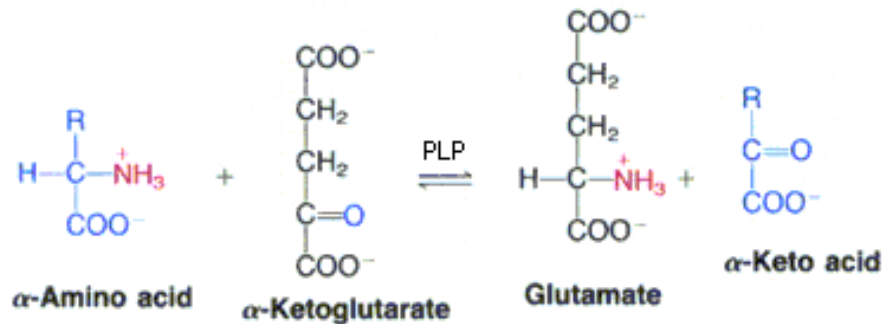

Fig 5.23: Transamination of amino acids

Transaminase of Clinical Importance

Transaminase is a name for a category of enzymes involved in exchange of an oxygen from an α -keto acid (such as α -ketoglutarate) and an amine from an amino acid

The two most important transaminase reactions of high clinical importance are Alanine transaminase and Aspartate transaminase catalyzed reactions.



In addition to their roles as building blocks of proteins, the carbon skeletons may be used to produce energy in oxidative metabolism by the end stages of glycolysis (such as pyruvate from Alanine) and tricarboxylic acid (such as oxaloacetate from Aspartate) thereby providing a metabolic fuel for tissues that require or prefer glucose. In addition, the carbon skeletons of certain amino acids can produce the equivalent of acetyl-CoA or Acetoacetate termed Ketogenic, indicating that they can be metabolized to give immediate precursor of lipids or ketone bodies.

Alanine transaminase (ALT) also called as glutamate pyruvate transaminase (GPT) and Aspartate transaminase (AST) also called as glutamate oxaloacetate transaminase (GOT) are the two most important transaminases of clinical importance. These enzymes are abundant in heart and liver they are released as part of cell injury that occurs in Myocardial infraction (MI), infections hepatitis and damage to either organ. An elevated level of both SGOT and SGPT

(S=Serum) indicates damage to the Liver. However a rise in SGOT accompanied by only a moderate rise in SGPT suggests damage to heart muscle, skeletal muscle, kidney etc. Assays of these enzyme activities in blood serum can be used both in diagnosis and in monitoring the progress of a patient during treatment.

SGOT: Oxaloacetate + Glutamate <-> Aspartate + -Ketoglutarate

SGPT: Glutamate + Pyruvate -----> -Ketoglutarate + Alanine

Aminotransferases utilize a coenzyme - pyridoxal phosphate - which is derived from vitamin B6. The functional part of pyridoxal phosphate is an aldehyde functional group attached to a pyridine ring. Catalysis involves a Schiff base intermediate.

Oxidative deamination

Involves the oxidative removal of the amino group, also resulting in ketoacids. the amino acid oxidases are flavoprotein, and produces ammonia.

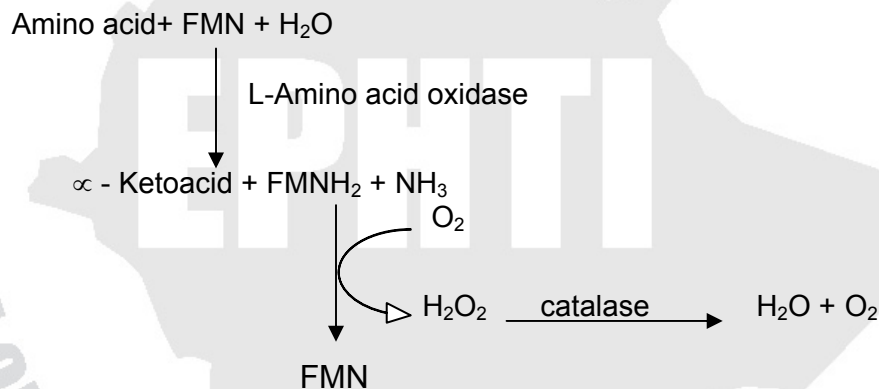

Fig 5.24: oxidative deamination of Amino acids

Dehydration Mechanism

A second means of deamination is possible only for hydroxyamino acids (serine and threonine), through a dehydration mechanism that involves a dehydration followed by the readdition of water and loss of the amino group as ammonia. Dehydration occurs before deamination and PLP is the prosthetic group.

Deamination of serine and threonine is slightly different because of the *beta*-hydroxyl groups. Dehydratases are involved:

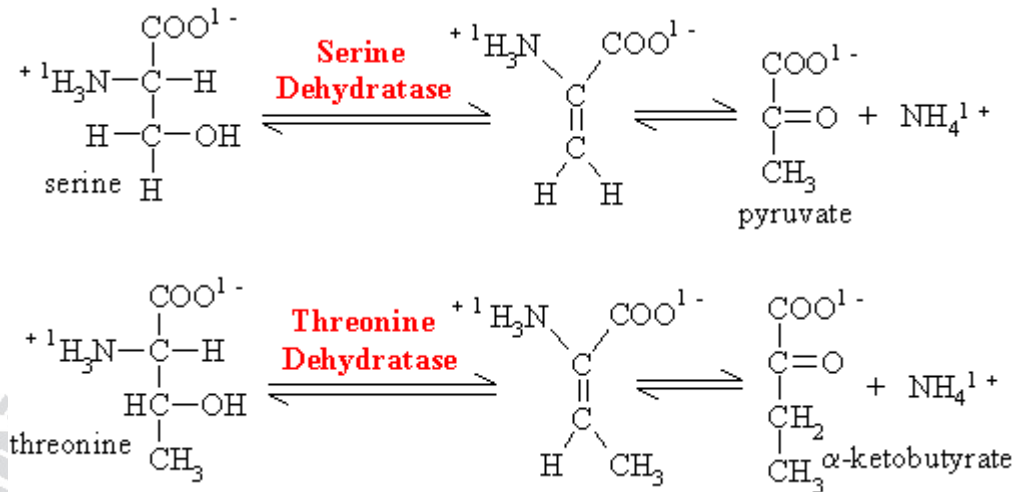

Fig 5.25: Dehydration of amino acids

Nitrogen Balance:

A healthy adult eating a varied and plentiful diet is generally in “Normal Nitrogen Balance” a state where the amount of nitrogen ingested each day is balanced by the amount excreted resulting no net change in the amount of the body Nitrogn. In a well fed condition, excreted nitrogen comes from digestion of excess protein or from normal turnover.

Protein turnover (Synthesis and degradation)

Under some conditions.the body is either in negative or positive nitrogen balance. In negative nitrogen balance more nitrogen is excreted than ingested. This occurs in starvation and certain diseases.During starvation the carbon skeleton of most amino acids from proteins fed in to gluconeogenesis to maintain the blood glucose level ; in this process ammonia is released and excreted mostly as urea and is not reincorporated in to protein.

Positive nitrogen balance occurs in pregnancy and during feeding after starvation.

A diet deficient in an essential amino acid also leads to a negative nitrogen balance since body proteins are degraded to provide the deficient essential amino acid.

Positive nitrogen balance occurs in growing children who are increasing their body weight and incorporating more amino acids in to protein than they breakdown. Cysteine and Arginine are

not essential in adults but essential in children because they are synthesized from Methionine and ornithine. These amino acids are readily available in adults but limited in children.

Negative Nitrogen balance occurs in injury when there is net destruction of tissue and in major trauma or illness.

Nitrogen Excretion and the Urea Cycle:

Excess amino Nitrogen from amino acids is removed as ammonia, which is toxic to the human body. Some ammonia is excreted in urine, but nearly 90% of it is utilized by the liver to form urea, which is highly soluble and is passed in to circulation for being excreted by the kidneys. Daily excretion of urea amounts to about 30g with a protein intake of nearly 100g in the food. It is less with lower protein intake. The urea-cycle starts in the mitochondrial matrix of hepatocytes and few of the steps occur in the cytosol: the cycle spans two cellular compartments. The first amino group to enter the cycle is derived from ammonia inside the mitochondria. Some ammonia also arrives at the liver via the portal vein from the intestine, when it is produced by bacterial oxidation of amino acids.

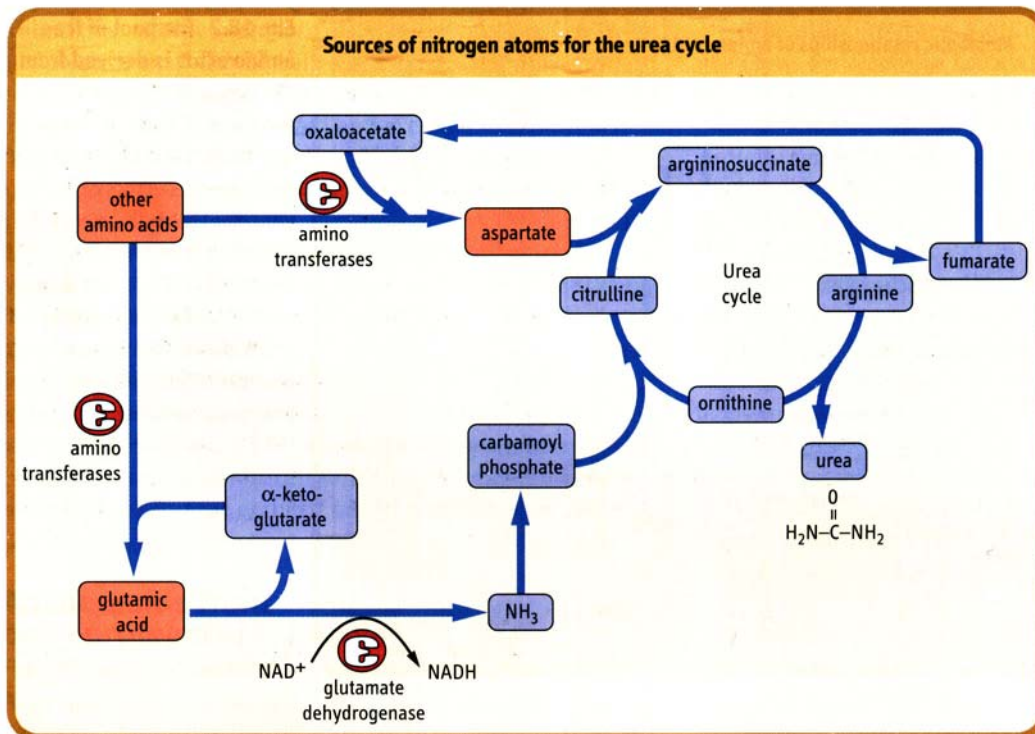
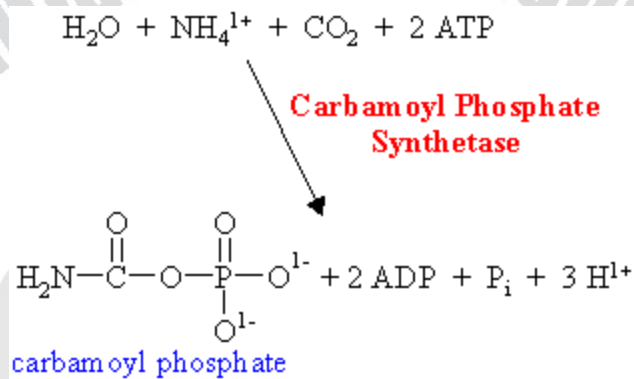

Fig 5.26. The Urea Cycle:

The reactions are as follows:

Step 1. CO₂ from bicarbonate and NH₄ from the two sources mentioned above combine together in the liver mitochondria to form carbamoyl phosphate in presence of ATP and Mg²⁺ by the enzyme Carbamoyl phosphate synthetase I (CPSI).



Step 2. Carbamoyl phosphate reacts with ornithine transferring the carbamoyl moiety to produce citrulline: by the enzyme i.e. ornithine transcarbamoylase.

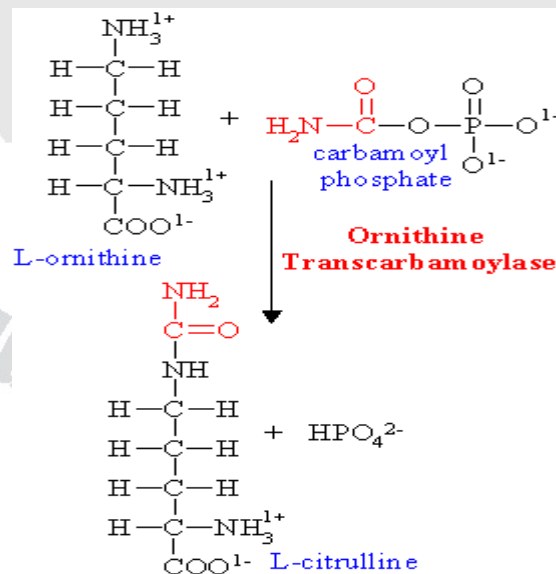

Step 3. Argininosuccinic acid is formed by the reaction of Aspartic acid and citrulline: the NH₂ group of the former is linked to – CO group of the latter. The enzyme required is argininosuccinic acid synthetase.

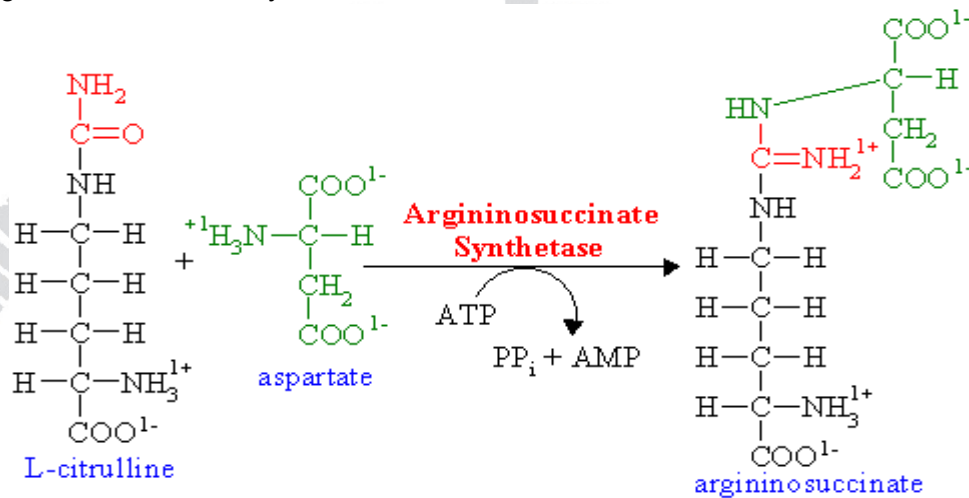

Step 4. Argininosuccinic acid is cleaved to form Arginine and fumarate by the enzyme Argininosuccinate lyase. Fumarate goes to the pool of TCA-cycle.

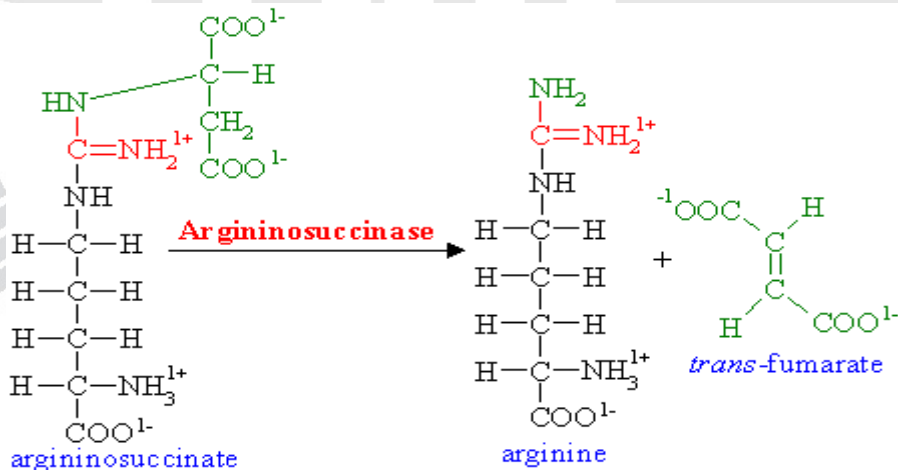

Step 5. Arginine gets cleared off to urea and ornithine by the cytosolic enzyme arginase. Ornithine is thus re-generated and can be transported in to the mitochondrion to initiate another round of the urea - cycle.

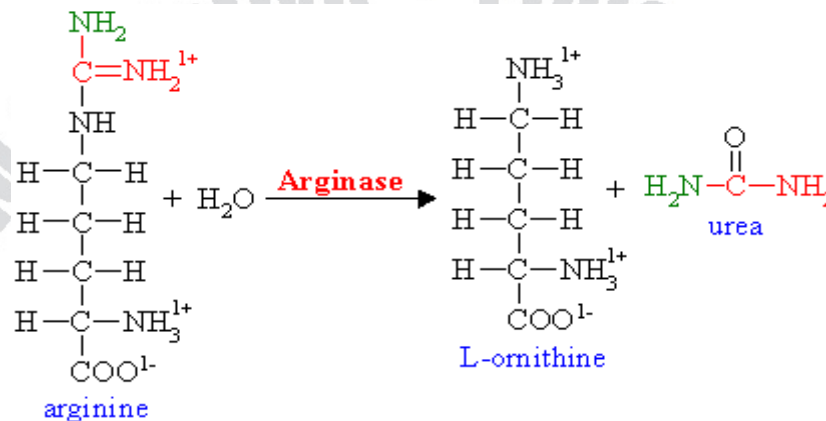

Energetics of the urea cycle

If the urea cycle is considered in isolation, the synthesis of one molecule of urea require four high energy phosphate groups

1. 2 ATPs used up to make up carbamoyl Phosphate
2. 1 ATP and two High- energy bonds to make up Arginosuccinate

- **Any reaction that creates a new C-N bond costs one ATP.**

However, the urea cycle also cause a net conversion of oxaloacetate to fumarate via Aspartate and regeneration of oxaloacetate produces NADH in the malate dehydrogenase reaction. Each NADH molecule can generate up to 3 ATPs during mitochondrial respiration.

The overall equation of the urea cycle is:



Regulation of the urea cycle:

The changes in demand for urea cycle activity are met in the long term by regulation of the rates of synthesis of the four urea-cycle enzymes and carbamoyl phosphate synthetase I in the liver.

All the five enzymes are synthesized at higher rates in starving animals and in animals on a very high protein diet than well fed animals eating primarily carbohydrates and fats.

Animals on protein free diets produced lower level of urea cycle enzymes.

The first enzyme CPSI is allosterically regulated by N- acetyl glutamate which is synthesized from acetyl-CoA and glutamate by N-acetyl glutamate synthase.

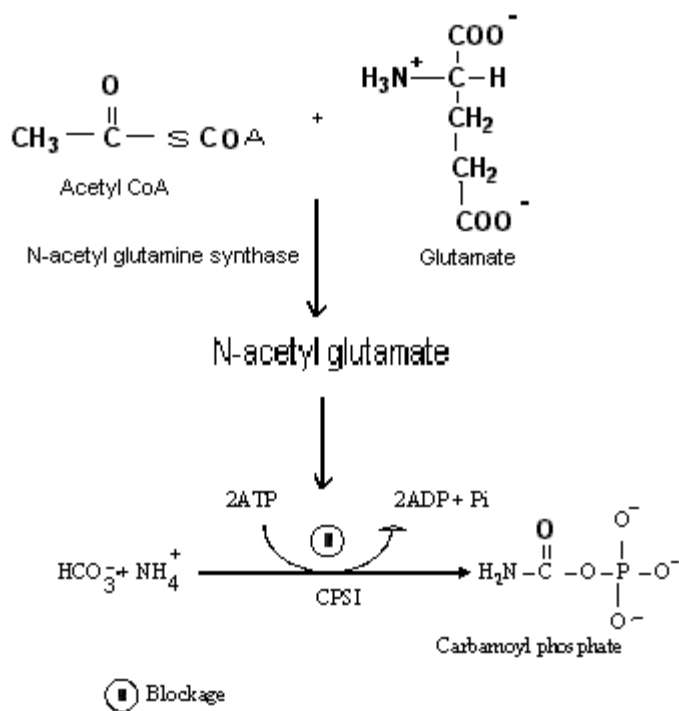

Fig 5.26: Regulation of the Urea cycle

Ammonia Toxicity (encephalopathy)

Ammonia is a universal participant in amino acid synthesis and degradation but its accumulation $> 25 - 100 \mu\text{g/dl}$ becomes toxic mainly to central nervous system (CNS). The reasons for toxicity of ammonia to CNS are as follows:

- 1) The major toxic effects of ammonia in brain probably involve changes in cellular P^H and depletion of certain TCA cycle intermediates.
- 2) More and more ammonia might deplete α -ketoglutarate an intermediate in TCA cycle to form Glutamate.
- 3) More and more glutamate might undergo decarboxylation to form γ -amino butyric acid (GABA) an inhibitory neurotransmitter that inhibits ATP Synthesis and accounts for the slurred speech and bizarre behaviors.
- 4) If the concentration of ammonia builds up it creates osmotic pressure by combining with H_2O leading to coma.

Acquired and Inherited defects in the Urea-Cycle.

Ammonia intoxication can be caused by inherited or acquired defects in ammonia trapping or in urea cycle most of the inherited defects occur at a rate of 1 in every 30,000 births all. Inherited defects in the urea –cycle enzyme result in mental - retardation.

<u>Disease</u>	<u>Defective Enzyme</u>	<u>Produce excessive amounts of</u>
Hyperammonomia		
Type I	CPS I	Ammonia
Type II	Ornithine transcarb- amoylase	Ammonia
citrullinemia	Arginosuccinate Synthase	Citrulline
Arginosuccinic	Arginosuccinatelyase	Arginosuccinate aciduria
Argenemia	Arginase	Arginine

Table5.6: Inherited defects in the urea cycle

N.B. Ammonia intoxication caused by inherited defects in the urea cycle enzyme after arginosuccinate synthase can be treated by a diet low in protein and amino acid and supplemented by Arginine and citrulline.

Treatment with sodium benzoate can produce additional disposal of non-urea nitrogen by combining with glycine the product hippuric acid, is excreted in the urine. Sodium phenyl lactate is even more effective, since it condenses with glutamine, the major carrier of excess Nitrogen. The resulting Compound phenylacetylglutamine is excreted carrying two nitrogen's with it.

Another mechanism for the treatment of defects in the urea cycle is the administration of ketoacids.

Acquired defects in urea-cycle

Any disease or condition that adversely affects liver mitochondria can also produce an increased level of ammonia in the blood such condition include liver cirrhosis, alcoholism, hepatitis, and Reye's syndromes.

The Glucose-Alanine Cycle

Alanine also serves to transport ammonia to the liver via the **Glucose-Alanine Cycle**: In a reversal of Alanine aminotransferase, Alanine transfers its amino group to α -Ketoglutarate, forming Glutamate in the cytosol of hepatocytes. Some of the glutamate is transported in to the mitochondria and acted by glutamate dehydrogenase, releasing ammonia.

The use of Alanine to transport Ammonia from a hard working skeletal muscles to the liver is an example of the intrinsic economy of living organisms, mainly because vigorously contracting skeletal muscle operate anaerobically producing not only Ammonia but also large amounts of pyruvate from Glycolysis.

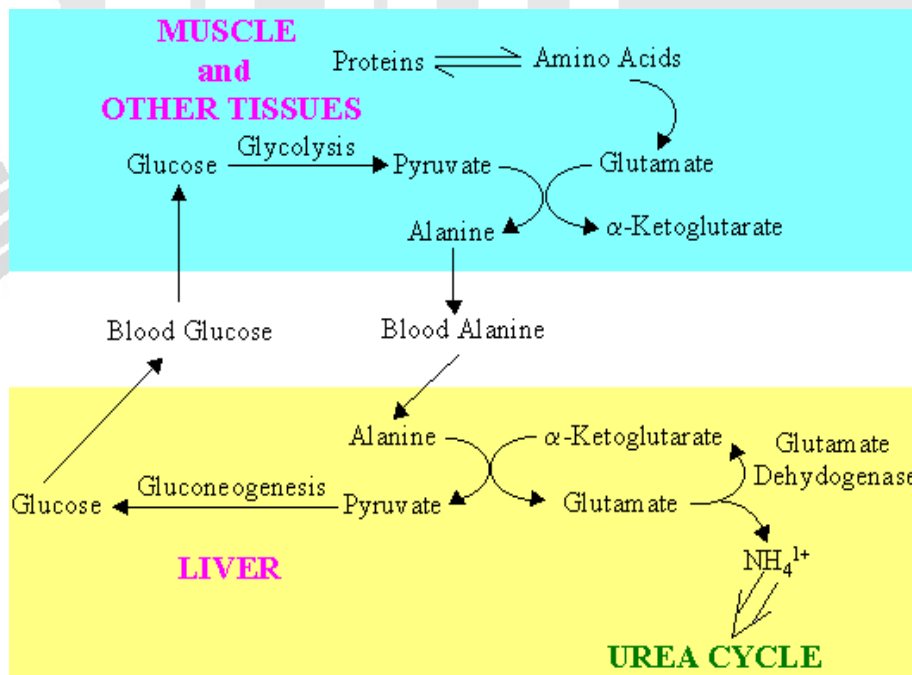

Fig 5.27: Glucose-Alanine Cycle

Inborn error in metabolism of amino acids

Degradation of phenylalanine

Degradation of phenylalanine and Tyrosine are unique. A series of reactions occur that use molecular oxygen to break the aromatic ring. In the initial reaction, phenylalanine is hydroxylated by phenylalanine hydroxylase, a monooxygenase that utilizes oxygen and tetrahydrobiopterin a pteridine co-factor.

Tyrosine is the only aromatic amino acid made in animals.

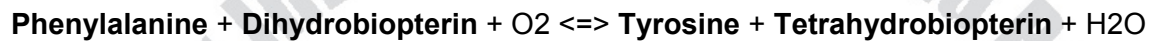

Deficiency of phenylalanine hydroxylase is responsible for Phenylketonuria (PKU), an Autosomal recessive disease that results in the accumulation of too much phenylalanine, because the synthesis of tyrosine is blocked. When untreated, this metabolic defect leads to excessive urinary excretion of phenyl pyruvate and phenyl lactate, followed by severe mental retardation, seizure, psychosis and eczema. Clear cur diagnosis requires measurement of plasma phenylalanine, which may be raised above 300mg/d. (normal 30mg/da).

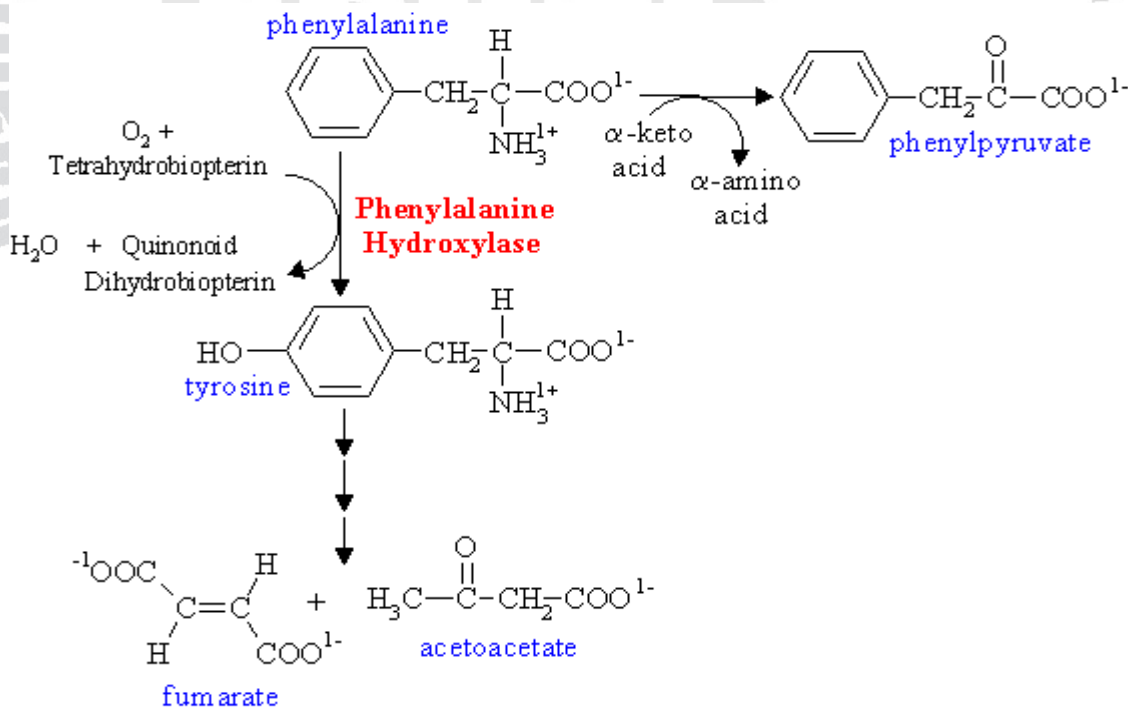

Fig 5.28: Phenylalanine catabolism

Tyrosinemia

It is also called (richner-Hanhrt syndrome) caused due to the failure of tyrosine transaminase giving a raised level of tyrosine in blood and urine clinical symptoms include moderate mental retardation, characteristic eye and skin lesions and disturbance in fine coordination. Other metabolites excreted in urine are called tyramine, N-a cetyl tyrosine, P-OH- phenyl acetate PO^4 - phenyl pyruvate.

Alkaptonuria (Black urine disease)

A second inherited defect in the phenyl a larine – tyrosine pathway involves a deficiency in the enzyme that catalyses the oxidation of homogentisic acid (an intermediate in the metabolic breakdown of tyrosine and phenyalanin). This condition occurs 1 in 1,000,000 live birth homogentisic acid accumulates and gets excreted in urine where the urine turns black on standing. There is a form of arthritis in late cases and generalized pigmentation of connective tissues; this is believed to be due to the oxidation of homogentisic acid by polyphenol oxidase forming benzoquinone acetate that polymerises and binds to connects tissues molecules.

High doses of ascorbic acid have been used in some patients, to help reduces the deposition of pigment on collagen, but progress of the disease has not been significantly affected by this strategy. Patients usually lead a normal life.

Maple syrup urine disease (MSUD)

The normal metabolism of the branched chain amino acids Leucine, Isoleucine, and valine involves loss of the α -amino acid by transamination followed by oxidative decarboxylation of the respective keto acids. The decarboxylation step is catalysed by branched chain α keto acid decarboxylase. In approximately 1 in 300,000 live birth in the general US population are affected by this enzyme defect leading to ketoaciduria. When untreated this condition may lead to both physical and mental retardation of the newborn and a distinct maple syrup odor of the urine.

This defect can be partially managed with a low protein or modified diet. In some instances, supplementation with high doses of thiamine pyrophosphate is recommended.

Amino acid derived Nitrogenous compounds.

Creatine and creatine phosphate:

Synthesis of creatine and creatine phosphate creatine is produced by the liver, kidney and pancreas and is transported to its site of usage principally muscle and brain. Creatine is derived from glycine and Arginine by the enzyme Amidinotransferase where ornithine and Guandioacetate are generated.

Further Guanidoacetate gets transmethylated by S- adenosine Methionine removing Adenosine and generating Homocystine and creatine. By creatine kinase, creatine undergoes phosphorylation to form creatine phosphate.

- Creatine phosphate is an important energy reservoir in skeletal muscles. Where at the site of muscle contraction creatine phosphates prevents the rapid depletion of ATP by providing a readily available high energy phosphate which can be used to re generate ATP from ADP.
- High levels of ADP formed in the myofibrils during contraction favors the reverse reaction namely formation of ATP at the expense of creatine phosphate cleavage to creatine.
- Creatine phosphate is formed from ATP and creatine at times when the muscle is relaxed and demands for ATP is not so great.
- Creatine is an end product of nitrogen metabolism, and as such, undergoe no further metabolism, but excreted through the urine.

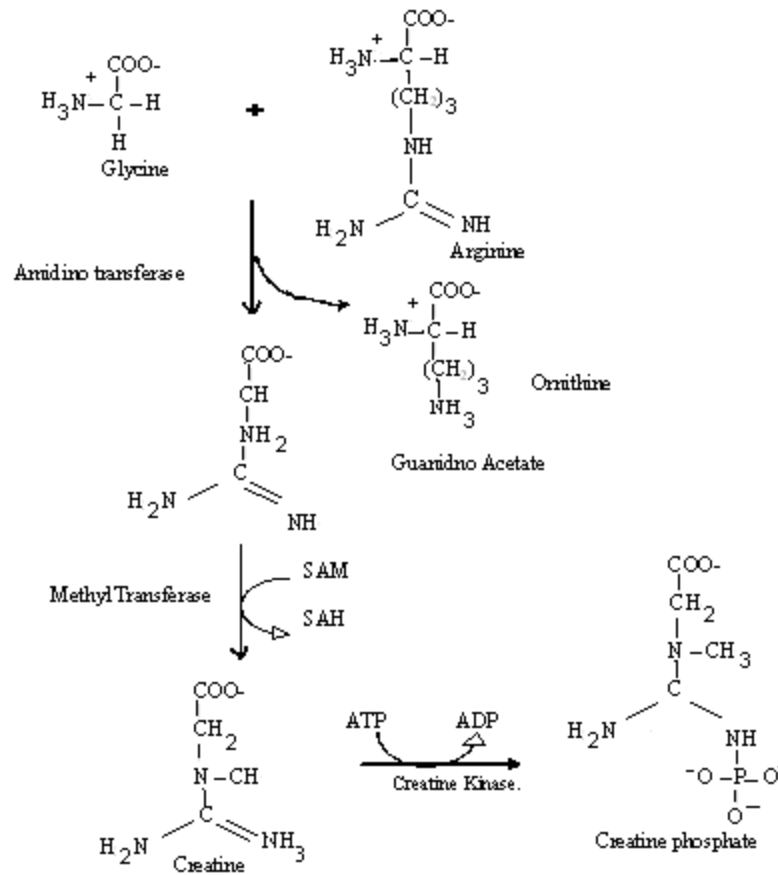

Fig 5.29: Synthesis of Creatine and creatine phosphate

Serotonin

Serotonin is synthesized from Tryptophan. It is a Neurotransmitter that helps the body control satiety, the feeling of fullness after eating. It plays multiple roles in the nervous system, including neurotransmission and a precursor of melatonin, which is involved in regulation of sleepiness and wakefulness, vegetative behaviors like feeding, mood, sexual arousal etc.

In the intestine, serotonin regulates intestinal peristalsis. It is also a potent vasoconstrictor, which helps regulate blood pressure.

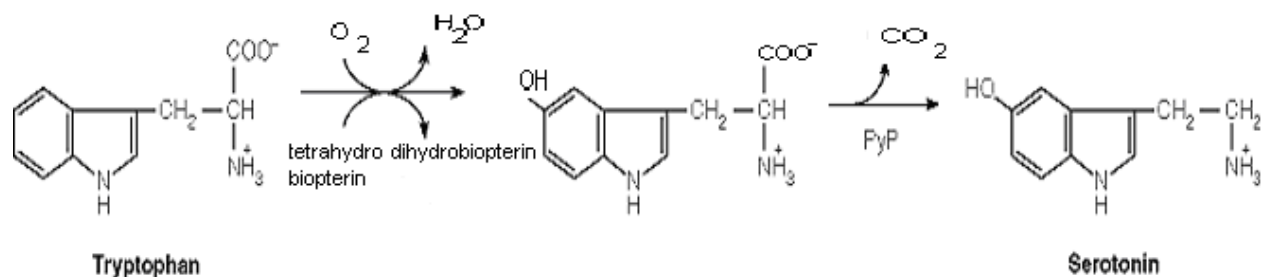

Fig 5.30: Biosynthesis of Serotonin

Catecholamines:

The term catecholamine comes from the aromatic dialcohol, catechole. Tyrosine gives rise to a family of catecholamines that include Dopamine, Norepinephrine and epinephrine. The levels of these catecholamines are related with changes in the blood pressure of animals.

Dopamine

The importance of Dopamine in neural transmission is emphasized by the number of major neurological disease that is associated with improper Dopamine regulation.

- Dopamine levels are abnormally low in a particular region of the brain of patients with Parkinson's disease
- Parkinson's disease commonly occurs in elderly, it can occur in younger individuals. It is a progressive disease caused by the death of dopamine-producing cells in the substantia nigra and locus ceruleus. This disease is associated with tremor of arm, occasional muscle cramping. The drug, which usually alleviates the disorder that contains L. dihydroxyphenylalanine and monoamine oxidase inhibitor.

Epinephrine

Epinephrine, also known as adrenaline is the principal hormone governing the fight or flight response to various stimuli. In addition it stimulates glycogenolysis (breakdown of glycogen), and a variety of physiological event, such as increasing depth and frequency of heartbeats.

Norepinephrine (nor-adrenaline)

It is a precursor of epinephrine. It causes greater constriction of the blood vessels of muscles, as a result of which the arterial pressure is raised higher than is caused by adrenalin. It acts as a neuro transmitter between sympathetic synthesis of catecholamines in nervous system and smooth muscles.

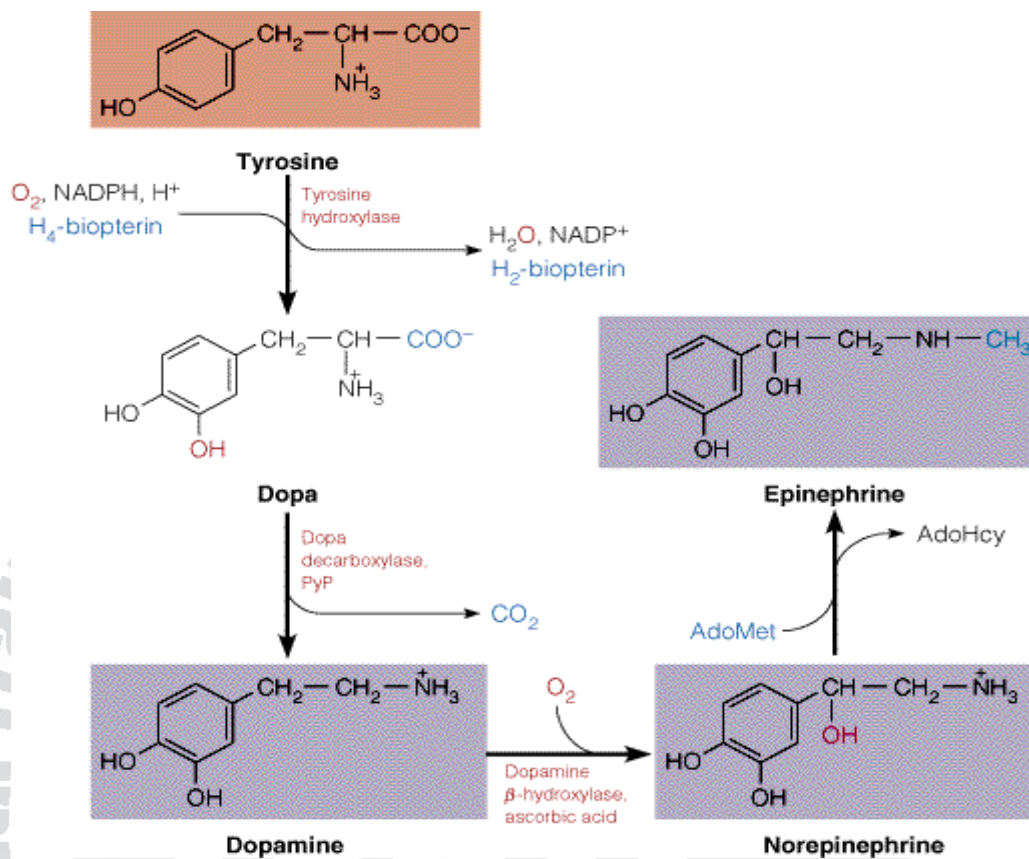

Fig 5.31 : Biosynthesis of Catecholamines

Histamine

Histamine is a decarboxylation product of histidine that is performed by a specific decarboxylase, or by the general L- amino acid decarboxylase. It is formed in the gut, injured tissues, and apparently in the normal tissue continually.

Histamine is released in large amounts as part of allergic response and it also stimulates acid recreation in the stomach being released by basophiles.

In the stomach, histamine promotes secretion of hydrochloric acid and pepsin as digestion aids. Histamine is a potent vasodilator, released at sites of trauma, inflammation, or allergic reaction. Reddening of inflamed tissues is a result of local enlargement of blood capillaries. Antihistamines block binding of histamine to its receptors.

It also acts as a neurotransmitter in brain, and perhaps, may be considered as a local hormone. The action of histamine is terminated by histaminase.

A drug cimetidine (tagamet) is a structural analogue of histamine, mainly used to alleviate hyperacid secretion by interfering on the mechanism action of histamine.

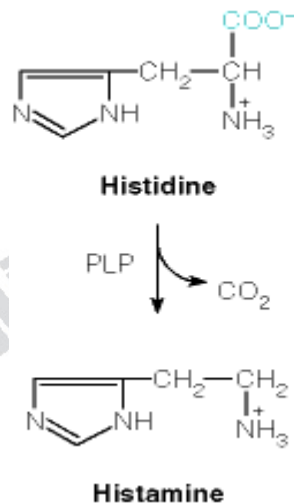

Fig 5.32 : Biosynthesis of Histamine:

Melanin:

Conversion of Tyrosine to Melanin requires Tyrosinase, a copper containing Enzyme. The two step reaction uses DOPA as a cofactor internal to the reaction and produces Dopaquinone, commonly called as Melanin.

During Melanogenesis following exposure to UV light, tyrosinase is post transcriptionally induced along with a tyrosine related protein.

Melanin is a dark pigment found on hair, eyes and skin. A deficiency of Tyrosinase enzyme leads to a disorder known as Albinism.

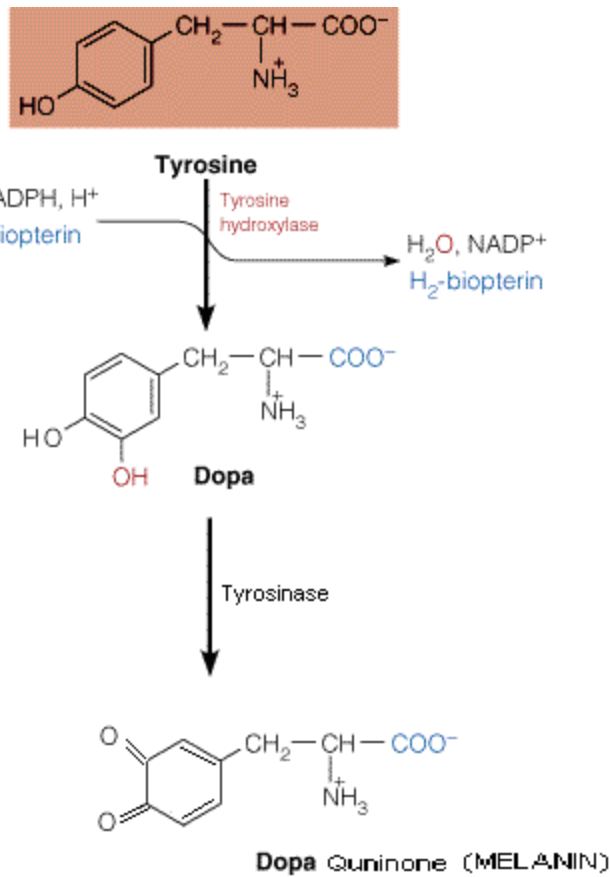

Fig 5.33 : Melanin Biosynthesis

Clinical problems

- I. Explain with reasons whether high protein diet plans serve to reduce weight especially in obese people.
- II. An otherwise healthy 64 year-old women noticed that she occasionally had a tremor in her left arm and occasional muscle cramping in her left leg. She was given a medication that contained L- dihydroxyphenylalanin and monoamine oxides .Comment on the pathological condition arose on the women.
- III. An apparently healthy 5-month old female's infant was brought to a pediatrician's office by her mother with a complaint of periodic bouts of vomiting and failure to gain weight. The mother also reported that the child would oscillate between periods of irritability and lethargy.

Laboratory results revealed as

- marked by increased plasma ammonia concentration (323 μ mol/L [550 μ g/dl])

Normal range = 15-88 μ mol/L {25-150 μ g/dl}

- Greater concentration of glutamine

- Low concentration of Insulin.

Orotate, a pyrimidine nucleotide precursor was noted to be excreted in the urine.

- IV. A full term infant born to a normal and healthy mother and father, was observed to have a marked lack of pigmentation: had blue eyes and many white patches on his hair. Comment on the pathological symptoms of the child and outline of this pigment forming pathway.
- V. Growing children and patients recovering from trauma, surgery and major burns require more high quality protein rich in essential amino acids in addition they excrete less nitrogen than they consume. Explain
- VI. Patients with gastric or duodenal ulcer, or both, often experience chronic Recurrence, in these cases, what treatment would you choose?
- VII. A 68 year old man's hands shake uncontrollably. He finds it difficult to start walking and, once he has managed to start, he cannot stop easily. He cannot control his gait, suffers from uncoordinated sight and speech. Explain with reason what might happened to the person, with the means to alleviate the condition. Outline the pathway that is related to the disorder that the old man is suffering from.
- Failure of growth

UNIT SIX

VITAMINS AND COENZYMES

Vitamins

Introduction:

Vitamins are all organic compounds which, as originally defined, cannot be synthesized in the human body and must be provided in the diet. They are essential for the normal processes of metabolism, including growth and maintenance of health. It is known that the body is able to produce part or even all of its requirements for some of the vitamins, Example: Vitamin D from cholesterol and niacin from Tryptophan.

The Water soluble Vitamins

Include the B- Vitamins and Vitamin C. They share few common properties besides their solubility characteristics. Since they are water soluble excess can be excreted through urine. Hyper-vitaminosis may not cause toxicity. Most of these vitamins act as coenzymes.

The B- Vitamins are essential and must be provided through diet: these include:

- Thiamine (Vit B₁)
- Riboflavin (Vit B₂)
- Niacin (Nicotinic acid (or Nicotinamide)
- Pantothenic acid (Vit B₅)
- Vitamin B₆ (Pyrodoxine, pyridoxal, & Pyridoxamine)
- Biotin
- Vitamin B₁₂ (Cobalamin)
- Folic Acid

Thiamine (vit B₁)

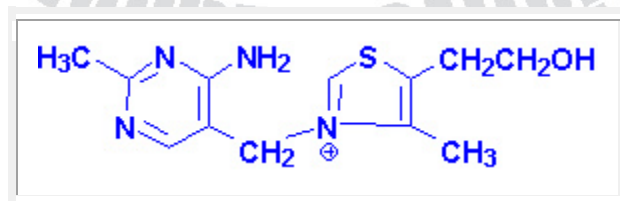

Thiamine is Vitamin B1. Addition of a pyrophosphate to **thiamine** (from ATP) converts it to thiamine pyrophosphate, a molecule that is the coenzyme for all decarboxylations of α -keto acids.

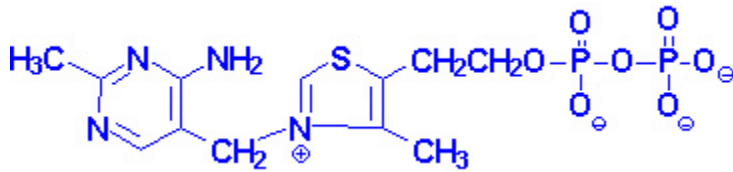

Thiamine pyrophosphate

Mechanism of action - **TPP** contains two heterocyclic rings, a substituted pyrimidine and a thiazole. The latter is the reactive moiety - specifically, the rather acidic carbon between the sulfur and the nitrogen. This carbon forms a carbanion, which in turn, can attack the carbonyl carbon of α -keto acids, such as **pyruvate**. This compound undergoes nonoxidative decarboxylation, with the thiazole ring acting as an electron sink, in forming a resonance-stabilized ene-amine. Protonation gives a species called active acetaldehyde, or hydroxyethyl-**TPP**.

Thus, in general terms, **TPP** functions in the generation of an activated aldehyde species, which may or may not undergo oxidation as it is transferred to an acceptor.

Some enzymes that use **TPP** include pyruvate decarboxylase, pyruvate dehydrogenase, branched chain α -keto acid dehydrogenase, α -keto glutarate dehydrogenase, transketolase.

Sources:

The good sources of Thiamine are: Seeds, Nuts, Wheat, Leguminous plants (rich source) & lean meat.

RDA: Minimum requirement 1.0mg for adults, infants and children 0.4-1.3mg

Requirement increases in conditions of Anoxia-shock, Hemorrhage, injury, illness, fever and hyperthyroidism. Also increased carbohydrate intake, pregnancy and lactation.

Deficiency: Causes Beri-beri and related deficiency syndromes.

Mainly caused by carbohydrate rich diets. In such individuals TPP dependent reactions are prevented, leading to accumulation of substrates like Pyruvate, Pentose sugars etc.

Symptoms: There are two types Dry beri-beri not associated with edema and wet beri-beri with edema, probably due to congestive cardiac failure and low plasma albumin. Symptoms include Peripheral Neuropathy, Exhaustion and Anorexia. The signs may progress to edema and Cardiovascular disorders, Neurological & muscular degeneration.

Wernicke Korsakoff syndrome which is frequently found in Alcoholics is associated with Thiamin deficiency.

Diagnostic parameters: Erythrocyte transketolase activity decreases.

Thiamine excretion in Urine and Blood thiamine concentration decreases.

Riboflavin (Vit B₂).

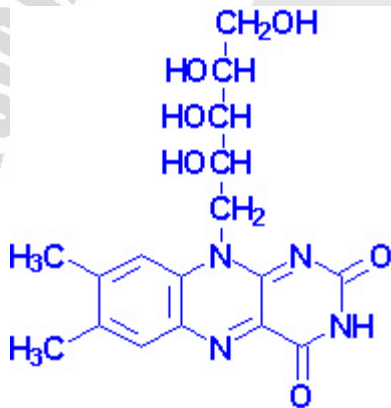

Riboflavin, also known as **vitamin B₂**, is a component of the flavin coenzymes, FAD and FMN. It is composed of an isoalloxazine ring system linked to ribitol. The ability of the ring system of **riboflavin** to exist as a semiquinone allows the flavin coenzymes to accept electrons either singly or in pairs. NAD⁺ and NADP⁺ can **only** accept electrons in pairs.

It is mainly used in the energy metabolism of Sugars and Lipids. The activation of FMN and FAD is an ATP-dependent.

Source: Meats, Nuts, Legumes, Milk, fish, egg etc.

RDA: 1.5-2.5mg for adults, infants 0.6mg, children 1.0-1.8mg

Deficiency: Lack of riboflavin in the diet causes a generally non fatal syndrome of inflammation of the corner of mouth (angular stomatitis), painful glossitis of tongue (Purple) and Scaly dermatitis.

A degree of photophobia may be due to its light sensitivity, because Riboflavin is colored, fluorescent and decompose in visible light but heat stable.

Erythrocyte enzyme activity measurements (Glutathione reductase) is used to determine Nutritional status of Riboflavin.

Niacin

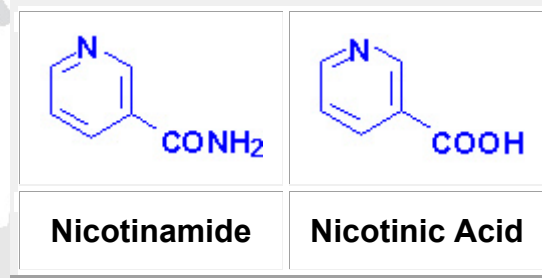

Niacin is not a vitamin in a strictest sense of the word, since it can be synthesized from Tryptophan. However, conversion of Tryptophan to Niacin is relatively inefficient (60 mg of Tryptophan is required to produce 1mg of Niacin) and occurs only after all the body requirements for Tryptophan is met. Thus most people require dietary sources of both Tryptophan and Niacin.

Niacin contains a substituted Pyridine ring and when gets activated forms NAD^+ and its phosphorylated derivative is NADP^+ . which are co enzymes of many dehydrogenases.

Source: Milk, Lean meat, Unrefined grains, cereals and from Metabolism of Tryptophan.

RDA: Adults 17-21mg, infants 6mg. The requirement increases with increased intake of calories, illness, severe injury, infection, burns, high corn (maize) diet, pregnancy and lactation.

Deficiency: Deficiency leads to Pellagra, a disease involving GIT and CNS.

The disease is characterized by intense irritation and inflammation of the mucous membranes of the mouth and other parts of the GIT, leading to gastro- intestinal hemorrhage, Dermatitis, Dementia & Diarrhea. (the “3-D’s” cardinal features). Skin lesions develop when exposed to sunlight, become red, thickened and become scaly. The patient develops gingivitis and stomatitis (Tongue gets swollen) General effects of deficiency are Failure of growth, loss of weight and anemia.

The case will be severe in Alcoholics.

Vit B₆ (Pyridoxine)

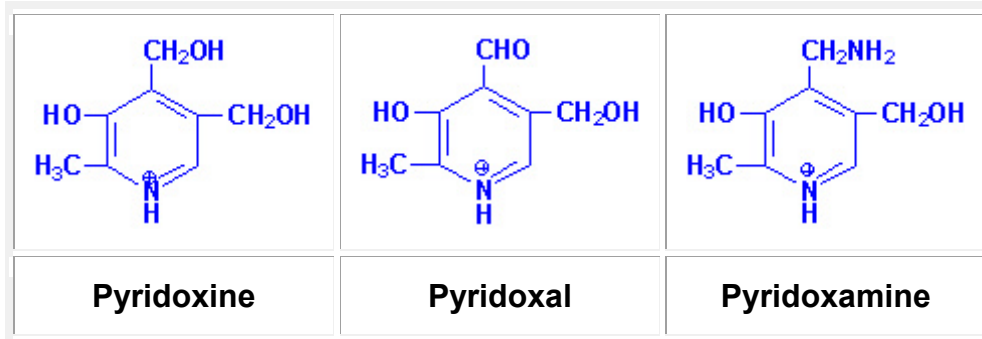

Exists in three forms: Pyridoxine, Pyridoxal & pyridoxamine and their corresponding phosphates.

Pyridoxal phosphate (PLP)

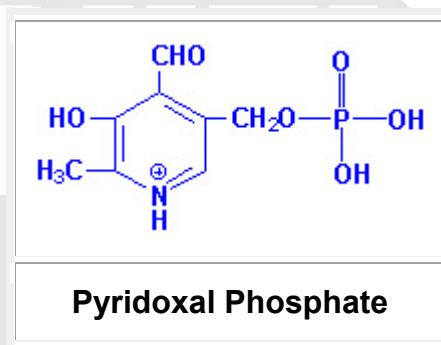

Pyridoxal phosphate participates in transaminations, decarboxylations, racemizations, and numerous modifications of amino acid side chains. All **pyridoxal phosphate**-requiring enzymes act via the formation of a Schiff base between the amino acid and coenzyme. A cation (a metal or a proton) is essential to bridge the phenolate ion of the coenzyme and the imino nitrogen of the amino acid. This bridging maintains the planarity of the structure, which is essential for catalysis. The most important catalytic feature of the coenzyme is the electrophilic nitrogen of the pyridine ring, which acts as an electron sink, drawing electrons away from the amino acid and stabilizing a carbanion intermediate. It is also used for the synthesis of Neurotransmitter, Serotonin and Nor-Adrenalin. Used as a component of Sphingolipids necessary for myelin formation and Heme synthesis as well. Hypochromic microcytic anemia since PLP is required

for Heme synthesis. Deficiency in infants cause convulsions due to inactive glutamate decarboxylase, GABA not formed there by impaired neurotransmission.

It is an essential component of Glycogen phosphorylase; it is covalently linked to a lysine residue and stabilizes the enzyme. The conversion of Tryptophan to NAD also requires this co-factor.

Sources: Wheat, corn, egg yolk, Liver and muscle meat

RDA: 1.4-2.2mg for Adults, children 0.3-0.4mg. Patients with anti-tubercular treatment needs more Vitamin B₆.

Deficiency: usually is not common, but may result due to intake of drugs like Isoniazid and contraceptives. Alcoholics also suffer from such deficiency. Isoniazid binds to pyridoxine and makes it unavailable as a vitamin, causing peripheral neuropathy. oral contraceptives stimulate the synthesis of the enzyme which require this vitamin, thus causing deficiency .

Biotin

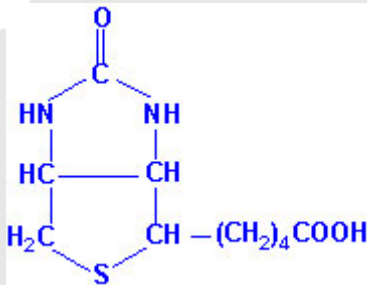

Biotin is a vitamin and a coenzyme commonly associated with enzymes performing carboxylation reactions. **Biotin** is typically linked covalently to carboxylase enzymes through the ϵ -amino nitrogen of lysine. Some of the enzymes that need Biotin for their activity include:

Acetyl-CoA carboxylase is the primary regulatory enzyme in fatty acid biosynthesis mediating the following reactions:

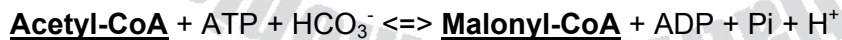

Pyruvate carboxylase is an enzyme of gluconeogenesis. It catalyzes formation of a carboxyl group on pyruvate (using CO_2) to make oxaloacetate.

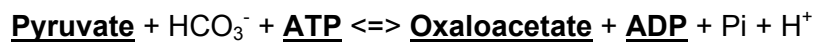

Source: Normally synthesized by intestinal bacteria.

Found in all foods particularly: Liver, egg, peanuts & milk

RDA: 100-200µg/day. Requirement increase in pregnancy and lactation. Patients on oral antibiotics for a long period of time require more of this vitamin.

Deficiency:

Rare, since it is found in almost all food stuffs. But large consumption of raw egg white may lead to deficiency of Biotin. Avidin, a glycoprotein in egg white binds tightly to biotin and makes it unavailable for the necessary carboxylation reactions.

The symptoms in this case are: Dermatitis, Glossitis, Muscle pain, depression, alopecia (Loss of hair), Loss of appetite and Nausea.

Vit B₁₂ (Cobalamin).

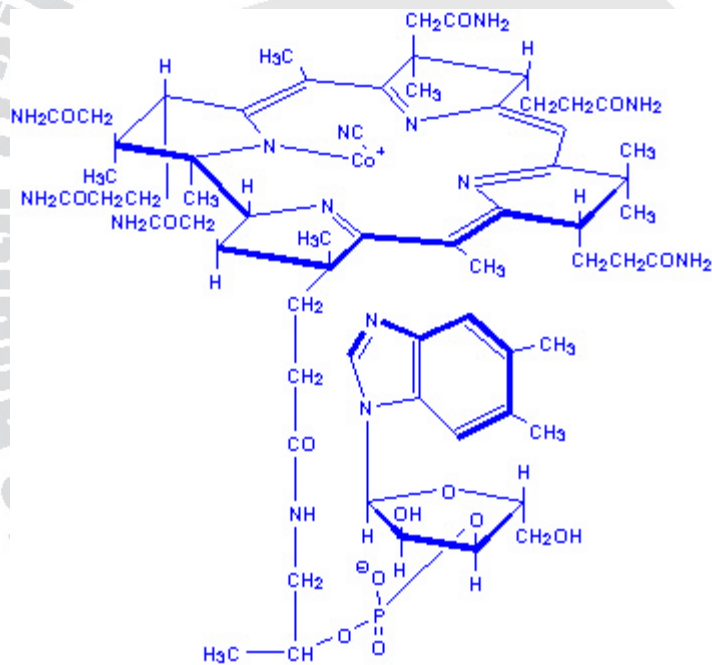

Figure: Structure of Cobalamin

The metal cobalt in **vitamin B12** is coordinated with a tetrapyrrole ring system, called a corrin ring, which is similar to the porphyrin ring of **heme** compounds. The cyanide attached to the cobalt in the structure is an artifact of the isolation and is replaced by water or a hydroxyl group in cells. The presence of cobalt and amide nitrogens gives **B12** compounds the name cobamides or cobalamins. Only two reactions occur to a significant extent in mammalian metabolism: the synthesis of **methionine** from **homocysteine**

B12- requiring reactions involve either (1) methyl group transfer or (2) adenosylcobalamin-dependent isomerizations. The isomerizations exchange a carbon-bound hydrogen with another carbon-bound functional group.

Pernicious anemia arises from a B12 deficiency. Gastric tissue secretes a glycoprotein called intrinsic factor, which complexes with ingested **B12** in the digestive tract and promotes its absorption through the small intestine into the blood stream. Pernicious anemia results from insufficient secretion of intrinsic factor. Outlines a probable explanation for why failure to absorb **B12** leads to the deficiency of red blood cells that define anemias.

1. When **B12** levels are low, flux through the methionine synthase reaction decreases but, because adequate dietary methionine is usually available, protein metabolism is not immediately disturbed.
2. Reduction of **5,10-methylenetetrahydrofolate** to **5-methyltetrahydrofolate** continues because this reaction is virtually irreversible.
3. Because methionine synthase is the only mammalian enzyme known to act on 5-methyltetrahydrofolate, the decreased intracellular activity of this enzyme causes 5-methyltetrahydrofolate to accumulate, at the expense of depleted pools of the other tetrahydrofolate coenzymes. Thus, even though total folate levels may seem ample, there is a functional folate deficiency, with insufficient levels of the formyl and methylene derivatives needed for synthesis of nucleic acid precursors.

The action of B12 and folic acid, are interrelated. Deficiency of both produce similar signs and symptoms and Anemias.

Source: Synthesized by Microorganisms

RDA: 3mg/day.

Deficiency: As discussed above

Folic Acid.

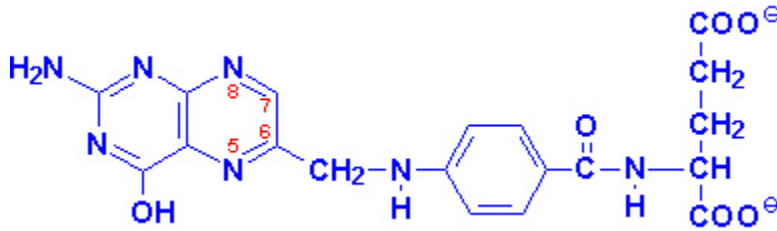

Figure: Structure of Folic Acid

The active form of folic acid is Tetra hydro folate (THF)

Coenzymes derived from the vitamin **folic acid** participate in the generation and utilization of single-carbon functional groups, methyl, methylene, and formyl. The vitamin itself was discovered in the 1930s, when it was found that people with a certain type of megaloblastic anemia could be cured by treatment with yeast or liver extracts. The condition is characterized, like all anemias, by reduced levels of erythrocytes. The cells that remain are characteristically large and immature, suggesting a role for the vitamin in cell proliferation and/or maturation.

Chemically, **folic acid** is formed from three distinct moieties: (1) a bicyclic, heterocyclic pteridine ring, **6-methylpterin** (**p-aminobenzoic acid**, **PABA**), which is itself required for the growth of many bacteria; and (3) **glutamic acid**. Naturally occurring **folates** may differ from this compound in the number of glutamate residues per molecule of vitamin, which ranges from three to eight or more. These residues are linked to one another, not by the familiar peptide bond but rather by a modified peptide bond involving the α -amino group and the γ -carboxyl group.

Source: The vitamin is abundant in leafy green vegetables such as spinach, so is named folic acid, from the same root as foliage, whole grain cereals and Liver.

RDA: 100 μ g/day (The RDA during Lactation & pregnancy are 500 - 800 μ g/day)

Deficiency: The causes of folate deficiency are inadequate intake, impaired absorption, increased demand during pregnancy, lactation and impaired Metabolism that leads to megaloblastic anemia. In this condition production of erythrocytes slows down, Macrocytic erythrocytes with fragile membrane are formed.

There may be also an inhibition in DNA synthesis due to decrease availability of Purines and dTMP. This leads to arrest cells in S-phase. Inadequate Folate Levels During the early stages of

Pregnancy Increases the risk of Neural tube defects (a type of birth defect) and spontaneous Abortions.

Folate deficiency is common in Alcoholics and in people who are on drugs like anti convulsants and oral contraceptives.

Pantothenic Acid (Vit B₅) Coenzyme A.

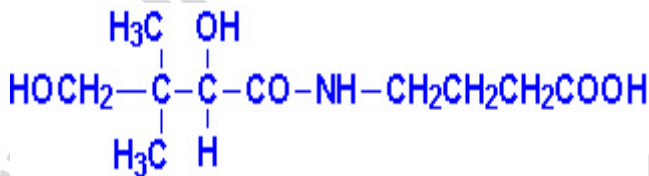

Figure: Structure of Pantothenic Acid

Pantothenic acid is a vitamin that forms an essential part of the acyl-carrier moiety, coenzyme A.

Coenzyme A (A for acyl) participates in the activation of acyl groups in general, including the acetyl group derived from **pyruvate**. The coenzyme is derived metabolically from **ATP**, the vitamin **pantothenic acid**, and **β-mercaptoethylamine**. A free thiol on the last moiety is the functionally significant part of the coenzyme molecule; the rest of the molecule provides enzyme binding sites. In acylated derivatives, such as **acetyl-coenzyme A**, the acyl group is linked to the thiol group to form an energy-rich thioester. The acylated forms of coenzyme A will be designated here as acyl-CoA, and the unacylated form as CoA-SH.

The energy-rich nature of thioesters, as compared with ordinary esters, is related primarily to resonance stabilization. Most esters can resonate between two forms. Stabilization involves Pi-electron overlap, giving partial double-bond character to the C-O link. In thioesters, the larger atomic size of S (as compared with O) reduces the Pi-electron overlap between C and S, so that the C-S structure does not contribute significantly to resonance stabilization. Thus, the thioester is destabilized relative to an ester, so that its ΔG of hydrolysis is increased.

The lack of double-bond character in the C-S bond of acyl-CoAs makes this bond weaker than the corresponding C-O bond in ordinary esters, in turn making the thioalkoxide ion (R-S⁻) a

good leaving group in nucleophilic displacement reactions. Thus, the acyl group is readily transferred to other metabolites, as occurs, in fact, in the first reaction of the citric acid cycle.

Some of the common metabolic reactions involving **Coenzyme A** are shown below.

1. **Pyruvate + NAD⁺ + CoA-SH \rightleftharpoons Acetyl-CoA + NADH + CO₂** (catalyzed by **Pyruvate Dehydrogenase**).

2. **Acyl-CoA + Carnitine \rightleftharpoons Acyl-Carnitine + CoA-SH** (catalyzed by **Carnitine Acyltransferase I**)

Sources: Eggs, Liver, Animal tissue, Whole grain cereals, Yeast and Legumes

RDA: 4-7mg/day

Deficiency: rare due to its wide distribution

The burning foot syndrome in prisoners which is associated with reduced capacity for acetylation is ascribed to pantothenic acid deficiency.

Vit C (Ascorbic Acid)



Figure: Structure of Ascorbic Acid

Vitamin C is a water-soluble vitamin. Collagen is unusual in its widespread modification of **proline** to **hydroxyproline** and **lysine** to **hydroxylysine**. Most of the hydrogen bonds between chains in the triple helix are from amide protons to carbonyl oxygens, but the OH groups of hydroxyproline also seem to participate in stabilizing the structure. Hydroxylysine residues in collagen serve to form attachment sites for polysaccharides.

The hydroxylation reactions in collagen involve **vitamin C**. A symptom of extreme **vitamin C** deficiency, called **scurvy**, is the weakening of collagen fibers caused by the failure to hydroxylate proline and lysine.

In general hydroxylation reactions require Vit C.

Example: Hydroxylation of cholesterol.

Functions:

- Collagen biosynthesis
- Degradation of Tyrosine
- Absorption of Iron
- Steroidogenesis
- Adrenaline synthesis
- Bile acid formation
- Degradation of tyrosine
- Bone mineral metabolism
- Potent anti oxidant

WBC's are rich in vit C and plays an important role in Immunity.

Source: Citrus fruits, Potato, tomato & green vegetables

RDA: 60mg/day

Deficiency: scurvy symptoms are spongy gums and bleeding of gums due to defective collagen synthesis.

Fat Soluble Vitamins

Ample reserves of fat soluble vitamins are stored in the tissues as they are not readily absorbed from the food. With the exception of Vit. K, they do not serve as coenzymes. Indeed Vit D act more like hormone.

Vitamin A

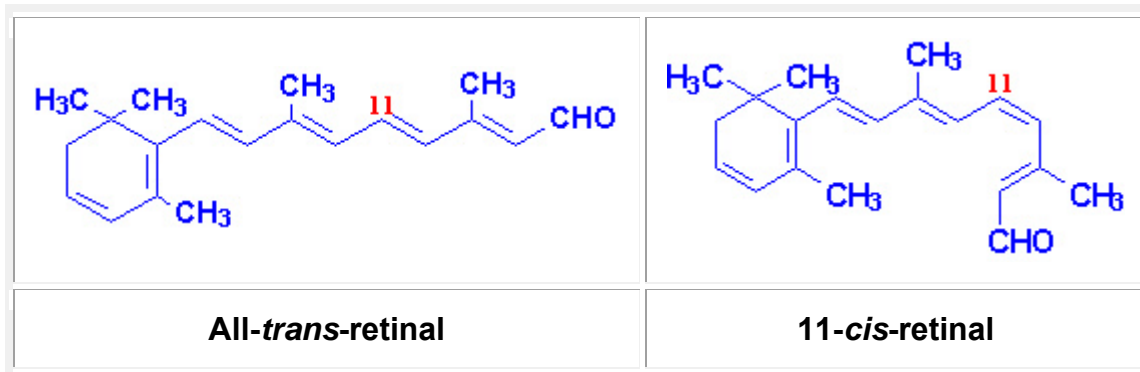

Figure.6.1 Vit A Structures

The vitamin is present in the diet as retinol or as β -carotene some of which is hydrolyzed in the intestine to form retinol. It is a generic term for a collection of three forms of Vitamins, retinol, retinal and retinoic acid (Retinoids) all of which are found from animal and plant sources.

Pre-Albumin and specific binding proteins on cell surface membranes are involved in the uptake of Vitamin A ester from the plasma into the tissues. Owing to the fat soluble nature, transport is effected by a specific proteins – serum retinol binding protein (SRBP), cytosolic retinol binding protein (CRBP) and Albumin as well as

A specific retinoic acid binding protein (RABP). The vitamin is stored in the liver, mainly as its ester. Some other derivatives of Vit A are stored in the Liver as retinol palmitate.

In natural sources VitA is present as esters of fatty acids. These as well as their precursors are readily absorbed from the intestine via the lymphocytes.

Pancreatic lipase liberates the free Vitamin from the ester during digestion, but it is re-esterified in the intestinal mucosa. Carotenone are converted to vitamin in the liver.

Source: A rich source is Liver, but leafy vegetables and some fruits provide the largest amount of β -carotene

Liver, egg yolk, butter and milk are good sources of β -carotene.

Functions

β -carotene has an antioxidant role and prevents the development of diseases in which the action of free radicals is implicated.

It plays a protective role against Cancer and cardiovascular disease.

As the normal proliferation of epithelial cell growth and differentiation depends on retinoids.

Retinal:

Vitamin A is necessary for vision mediated by the rod cells, so deficiency often presents as “**Night blindness**”, the first symptom of Vit.A deficiency.

The visual pigment, rhodopsin is found in the rod-cells of the retina and is formed by the binding of 11-cis retinal to the apoprotein opsin. When rhodopsin is exposed to light it gets decomposed (bleached), retinal dissociate and isomerized and reduced to all-trans retinol. This reaction is accompanied by conformational change and elicits a nerve impulse perceived by the brain as light.

The All-trans –retinol in the absence of light is converted back to 11-cis retinol by isomerase present in the cytoplasm of the rod cells. This recombines with scotopsin and rhodopsin to generate another cycle of action on exposure to light.

There is another route for the conversion of trans compound to cis compound in the dark, the aldehyde group of all-trans retinal is reduced to a primary alcoholic group reversibly by a dehydrogenase, aided by NADH+ H. The compound formed is OH-trans retinol. This is also acted by the isomerase to form 11-cis retinol which is reversibly oxidized to 11-cis retinal by dehydrogenase and NAD+ with the conversion of the alcoholic group to aldehyde group.

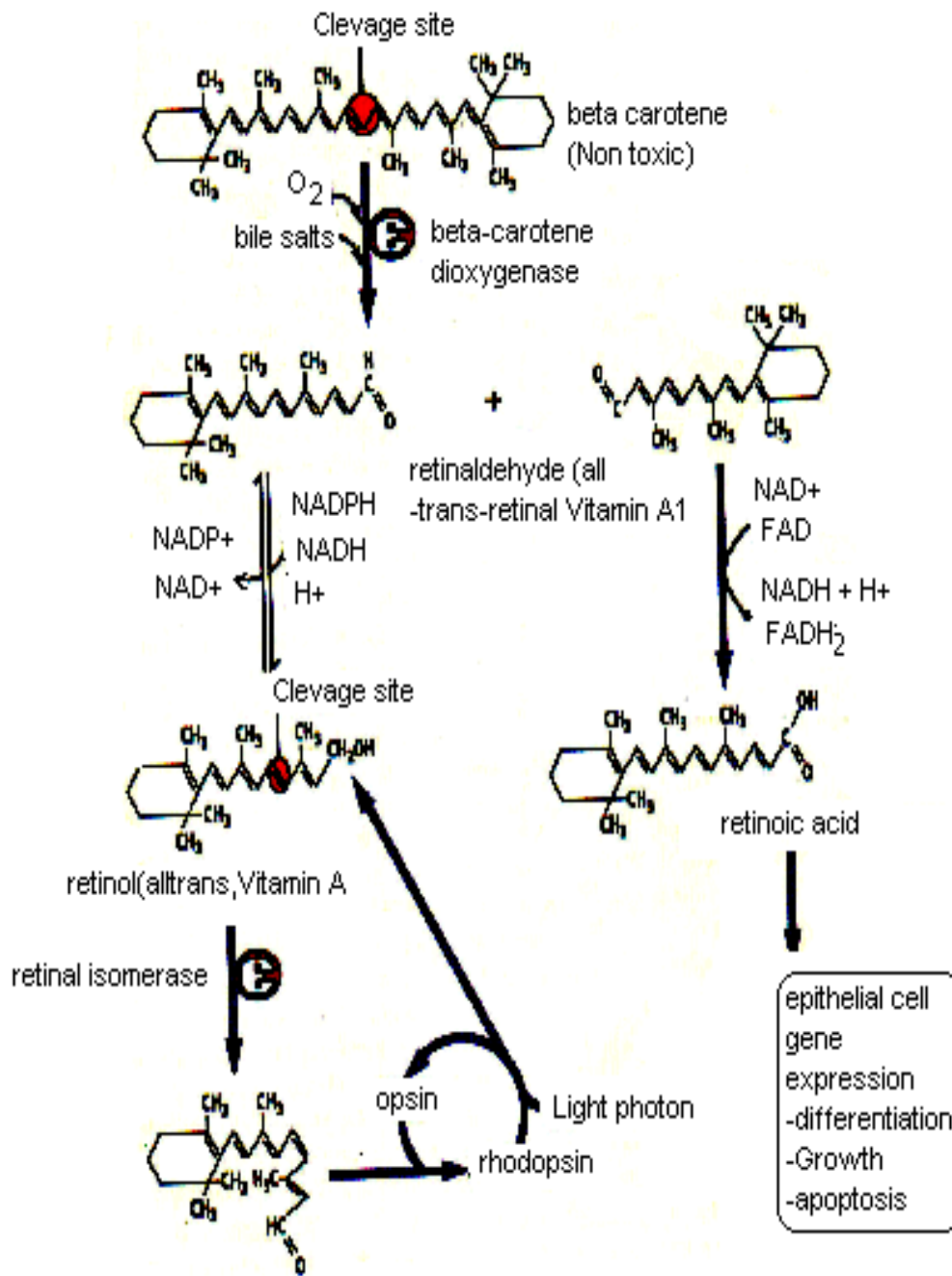

Fig.6.2 Vitamin A structure, function and Metabolism

Retinol: It gets phosphorylated and serves as an anchor for the growing chain of oligosaccharides. It prevents fetal resorption, promote spermatogenesis.

Retinoic acid: It is translocated to nucleus and control gene expression. It resembles steroid hormone because of this property. It promotes differentiation of epithelia. Acts as carrier of oligosaccharides for glycoprotein synthesis.

Vit A deficiency

Vit A affects growth and differentiation of epithelial cells leading to defective epithelialization, a condition affecting the cornea of the eye. It produces softening and opacity. Severe Vit A deficiency leads to progressive keratinization of the cornea and possibly permanent blindness. Another form, retinoic acid, induces differentiation of epithelial cells. Vit A deficiency predisposes to gastrointestinal and respiratory tract infections.

Plasma [Vitamin A] may be decreased in states of severe protein deficiency, due to lack of its carrier protein. Low plasma [Vitamin A] has been shown to be associated with an increased risk of developing cancer.

- Failure of bone formation (Thick, solid bones).
- Abnormal Keratin forms in the mucosal cells, cause keratomalecia in the eye.

Effect on Skin

The deficiency causes dryness and roughness of skin developing keratosis of hair follicles with concomitant deficiency of Vit-B complex.

Effect on Bone and teeth

Bone growth is markedly impaired. Osteoclastic activity is also hampered, causing defective bone formation.

Effect on general Metabolism

Zinc is necessary to maintain normal plasma concentration of Vit A. This vitamin is also necessary for the conversion of trioses to glucose perhaps indirectly through adrenal cortex that synthesizes hormones concerned with Gluconeogenesis.

Hypervitaminosis:

Excessive intake of vitamin A, in humans cause head ache, nausea, vomiting and dizziness. This might be related to increased spinal fluid pressure. Patient suffers from dry itchy skin, alopecia, cracking of lips etc. On withdrawal of vit, patient feels relief.

It is virtually impossible to develop vit. A toxicity by ingesting natural foods. When people consume supplements, there might be hypervitaminosis.

Vitamin D:

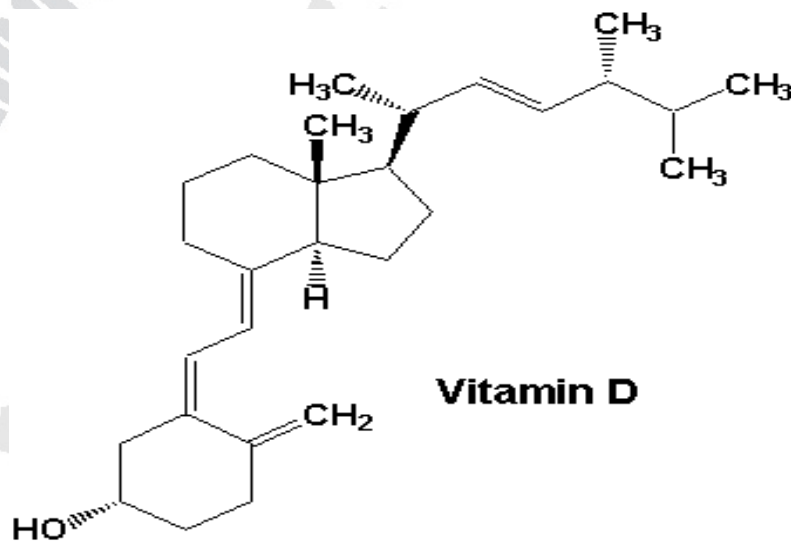

Fig.6.3 Structure of Vit D

Vitamin D is the only vitamin that is usually not required in the diet, for this reason it is rather classified as a hormone since under conditions of inadequate exposure to sunlight that dietary intake is required.

The sterol, 7-dehydrocholesterol is present below the deeper layer of epidermis, which is the precursor, produces under the influence of UV rays from sunlight. The first pro-vitamin D₃ (cholecalciferol) with rupture of the bond between C₉ and C₁₀. The product is directly related to the intensity of exposure to Uv. Rays and inversely to pigmentation of the skin. It is a photolytic process involving no enzyme and slows down with aging because of the decrease of 7-dehydrocholesterol.

Bound to specific D-binding protein, chloecalciferol moves via circulation directly to the liver.

Hydroxylation at C₂₁ takes place in the endoplasmic reticulum of hepatocytes in a non-regulating process. The 25 (OH)-chloecalciferol is a potent Vit.D₃ and is also produced in a smaller proportion in the kidney. Vit D₃ is also found in the diet where its absorption is associated with other fats, and is transported to the liver by chylomicrons

A significant proportion of 25 (OH)-D₃ is excreted in the bile and is reabsorbed in the small bowel, producing an enterohepatic circulation.

Disturbance in enterohepatic circulation can thus lead to deficiency of this vitamin.

The main site for further hydroxylation at the 1 position is in the renal tubules. Although bone and placenta can also carry out this reaction. Increase of serum calcium and phosphates autoregulate the synthesis. Hypocalcemia, Phosphatemia stimulates the release of PTH which enhances the synthesis of Vitamin D. On the other hand, high calcium, phosphate inhibit the synthesis.

Sources: Fish oils, egg yolk are naturally rich sources of Vit D.

Functions: Target organs are bone, Kidney and Intestine. Calcitriol promotes bone mineralization.

Intestine: This vitamin promotes absorption of calcium, phosphates. The mechanism of action resembles that of steroid hormone. It crosses cell membrane bind to cytoplasmic receptor to form a complex, which is translocated to the nucleus. Here it binds to chromatin, induces the synthesis of calcium binding protein. Thus calcium absorption is stimulated. Defect in cytoplasmic receptor may lead to Rickets.

Kidney: Reabsorption of calcium, phosphate are enhanced.

Bone: It promotes synthesis of osteocalcin which is needed for bone mineralization. It also promotes bone collagen synthesis.

Catabolism of Vit D:

Hydroxylation at C₂₆ takes place in Liver by oxidases. This compound has no Vitamin D activity.

Deficiency:

Usually deficiency of Vit D are due to insufficient exposure to sunlight, inadequate dietary intake, GI disorder, obstructive jaundice and Partial gastrectomy.

Rickets is characterized by the production of soft pliable bones due to defective mineralization secondary to calcium deficiency.

Vit D deficiency is also characterized by low concentration of calcium in blood in association with increased serum alkaline phosphatase.

Type I vit D dependent rickets

Is caused by an inherited defect in the conversion of 25(OH)-D₃ to calcitriol

Type II

Is a vitamin D-resistant rickets caused by absence of calcitriol receptor. In adults the deficiency produce Osteomalacia due to decreased absorption of calcium and phosphorous, maintains a low plasma level resulting in weak mineralization of bones.

Vit D toxicity

Excess Vit. D level enhances calcium absorption leading to hypercalcemia and metastatic calcium deposits. There is a tendency to develop kidney stones from the hypercalciuria, secondary to hypercalcemia.

Vitamin E

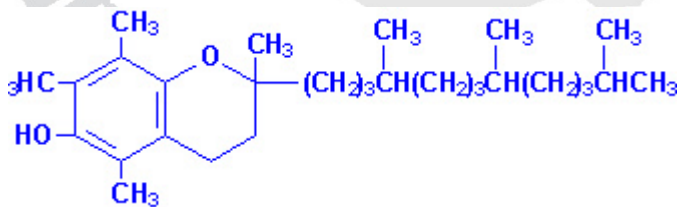

Fig.6.4 Structure of Vitamin E

Vit E is required in the human diet but deficiency is rare, Except in pregnancy and the new born, where it is associated with hemolytic anemia.

It exists in the diet as a mixture of eight closely related compounds called Tocopherols.

Source: The richest source is vegetable oils and nuts

Chemically Tocopherols are derivatives of an alcohol, tocol having a substituted Chromanone nucleus, with their poly isoprenoid side chain of variable length usually three carbons.

Functions

The main function of Vit E is as an antioxidant, in particular a membrane antioxidant associated with lipid membrane structure. It provides protection from the action of peroxides by converting them to a product that is conjugating with glucuronic acid and excreted in bile. This protective phenomenon is very much evident in the prevention of hemolysis of RBCs by H_2O_2 .

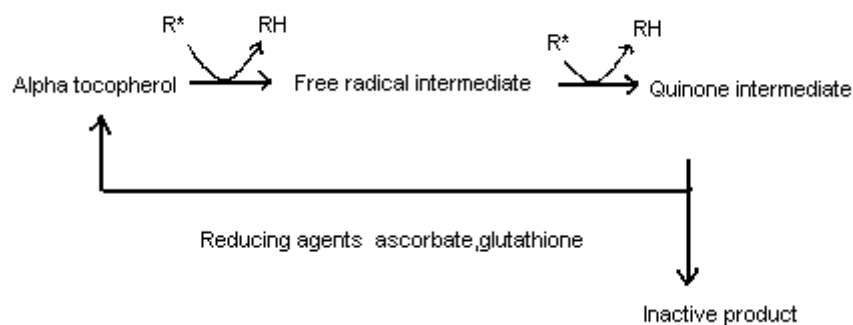

Fig 6.5: Antioxidant action of Vitamin E

R^* =free radical, RH= inactivated free radical

If peroxides are formed in excess, in the presence of vit E, selenium containing Glutathione peroxidase destroys them before any damage is caused to the membrane.

Also acts as scavenger of free radical damage to polyunsaturated fatty acids in cell membranes and help prevent oxidation of low density lipoprotein (LDL) Oxidized LDL may be more atherogenic than native LDL, and there is some evidence that Vit.E may protect against atheromatous coronary heart disease.

Source:

The richest source is vegetable oil, and nuts

Deficiency

Vit E deficiency is a rare but found in complication of prolonged and severe steatorrhea, and of prolonged parenteral nutrition.

Deficiency of Vit E causes anemia in children with cystic fibrosis of pancreas are found to be tocopherol deficient as a result of steatorrhea.

Neurological consequence has also been described. Generally deficiency is investigated by measuring plasma [Vitamin E].

Vitamin K

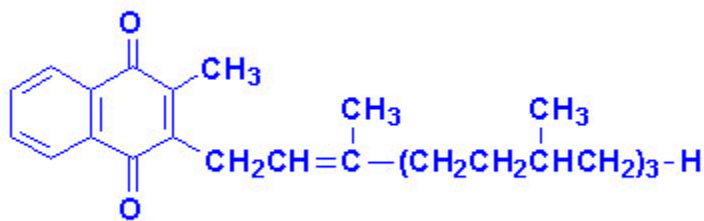

Fig 6.6 Structure of Vitamin K

It refers to a group of related compounds, varying the number of isoprenoid units in its side chain. There are three types, Menaquinone (K₂) present in animals, Phylloquinone (K₁) present in Plants. Menadione a synthetic water soluble vitamin is available for treatment.

Like vit E, the absorption of Vitamin k is dependent on appropriate fat absorption.

Functions

It is the only one acting as co-enzyme from the group of Fat soluble vitamins.

This vitamin is also synthesized by intestinal bacteria. It is required for post translational modifications of several proteins required in the coagulation cascade. For e.g. Factor II, VII, IX and X.

Activation is carried out by the carboxylation of specific glutamate residues on the prothrombin by Vit K dependent enzyme. The presence of a second carboxyl group on the glutamate (γ -

carboxy glutamate) side chain confers phospholipids binding properties on the Prothrombin in the presence of Ca^{2+} . Conversion of prothrombin to thrombin is important for clotting.

Deficiency

It is widely distributed in nature and produced by the intestinal micro flora. Virtually ensures that dietary deficiency does not occur in man. However, it is found in patients suffering from Liver diseases (obstructive jaundice), in new born infants and in patients with malabsorption. It is associated with bleeding disorders. The placenta is inefficient at passing maternal Vit K to the fetus and immediately after birth the circulation concentration drops, but recovers on absorption of foods. In addition the gut of the new born is sterile, so that the intestinal micro flora does not provide a source of vit K for several days after birth. This is the reason why adults who are on prolonged antibiotic treatment require supplementation of Vit.E.

Specific inhibitors of Vit. D dependent Carboxylation reactions are used in the treatment of thrombosis related diseases. These drugs of the dicoumarin groups for eg. Warfarin, which inhibit the action of Vit K - probably via the mechanisms involved in the regeneration of the active hydroquinone.

Tests to assess Vitamin K status include the prothrombin time-an important test in the investigation and management of jaundiced patients and of those on anticoagulant treatment.

UNIT SEVEN

MINERAL METABOLISM

Large number of elements are needed for the functioning of the body. Some elements are needed at high concentrations, required more than 100mg per day. They come under macroelements. Example. Sodium, Potassium, Calcium, Magnesium and Chloride.

Sodium and Potassium: They are important in cell, muscle physiology, transmission of messages and other biological processes.

Sodium is the principal cation of extra cellular fluid. It is commonly found in all types of foods. Recommended daily allowance (RDA) is 5-10 gms. It is excreted in the urine. The concentrations are maintained by Aldosterone.

Potassium is intracellular cation; daily requirement is 1 gm/day. Its excretion is through kidney, linked to sodium excretion.

Since both are widely distributed, deficiency of the two elements is rarely found.

Functions:

- Sodium maintains osmotic pressure of extra cellular fluid and ECF balance.
- It has a role , along with others, in the neuro muscular excitability
- Sodium is exchanged with Hydrogen in renal tubules to acidify urine.
- Sodium pump keeps sodium in far higher concentration outside the cell .This results high polarization, create resting membrane potential.
- Sodium and Potassium maintain the degree of hydration of plasma proteins, and there by viscosity of blood.
- Potassium is critically important for the functioning of cardiac muscle.

Hypernatremia: It occurs nearly always due to water deficiencies rather than Na^{2+} excess.

Increased sodium is found in ECF. It may be due to increased sodium in the body, decreased body water. It is usually seen in patients with dehydration, on steroid therapy or excess sodium intake.

Hyponatremia: It is common in patients who are in diuretics or excessive sweating, kidney disease, diarrhea and congestive heart failure.

Hyperkalemia is found in patients who are on excess intake orally or given intravenous drip. Other causes are decreased excretion by the kidney, diseases like Anuria, tissue damage or Diabetes Mellitus.

Hypokalemia: Low potassium is not due to dietary deficiency but due to conditions like vomiting, diarrhea. Habitual users of laxatives are prone to the condition.

Calcium and Phosphate: Major parts (90%) of them are found in the form of crystal lattice in the bone. Rest is found in the soft tissues, teeth and ECF. In plasma they have important role.

Sources: Milk, milk products, green leafy vegetables are rich in calcium.

Phosphate is widely distributed in nature.

Calcium: RDA 500mg for adults and 1200mg for children, 1500mg for post-menopausal women. People, who get enough sunlight, exercise regularly, on high protein diet, require 300-400mgs per day.

Absorption: It is influenced by

- Acidic pH solubilizes Calcium salts, promote absorption.
- High protein diet favors absorption
- Certain plant products, high fiber diet, oxalates interfere with absorption.
- Vitamin D promotes absorption.
- PTH, Calcitonin favors absorption while Glucocorticoids decrease intestinal transport.
- Normal blood concentration is critically maintained at 9-11 mg %.

Functions:

- Calcification of bones and teeth. Bone formation requires Calcium continuously.
- It is important for blood coagulation
- Neuromuscular transmission.
- Muscle contraction
- Acts as secondary messenger in hormone action.

Clinical conditions:

Hyper- calcemia; may be due to hyper parathyroidism, endocrine causes, renal failure and malignancies. Hypo- calcemia (below 8.5mg %) due to

- Inadequate dietary intake.
- Hypoalbuminemia
- Hypo parathyroidism

- Renal disease/ failure
- Vitamin D deficiency

Chronic deficiency leads to loss of bone mass (bone resorption) and osteoporosis, bone fractures

Phosphorus: Dietary sources are cheese, milk, nuts. Eggs and organ meats.

Absorption and regulation is similar to that of Calcium.

Functions:

- Constituent of bone and teeth
- Needed for the synthesis of energy rich molecules like ATP and Creatin phosphate.
- It forms Phosphate buffer in blood.
- Constituent of phospholipids, biomolecules and coenzymes (TPP).

Trace elements

Daily requirements of some elements is very very less .Such elements are included in trace elements.

Iron

In body it is found in Haemoglobin, Myoglobin, ferritin, hemosiderin, transferrin and enzymes like cytochromes etc.

RDA is 10-20mgs. Sources are meat, fish, eggs, cereals like wheat & Teff, green leafy vegetables. Milk is deficient in Iron.

Absorption is through intestinal mucosa.

Requires acidic pH of stomach. Ascorbic acid and Ceruloplasmin promotes absorption.

It combines with intracellular binding protein Apoferritin to ferritin. Almost 300 ferric ions can bind to one molecule of apoferritin..

For transport, free iron binds to Apo transferrin, in blood to form transferrin.It is the major transport form of iron. It also prevents toxicity of free iron.

Excessive binding of iron causes denaturation of ferritin molecule. It undergoes aggregation, to form hemosiderin. Mobilization of iron from hemosiderin is very slow. Thus there is accumulation of hemosiderin, the condition is called hemosiderosis.

Massive deposits of hemosiderin in tissues lead to hemochromatosis. If this takes place in liver, it causes cirrhosis. In pancreas, it damages β cells, result in Bronze diabetes. The skin of the patient has bronze coloration. Oxidative damage to cardiac muscle is a biggest concern.

Iron is stored in liver, spleen and bone marrow.

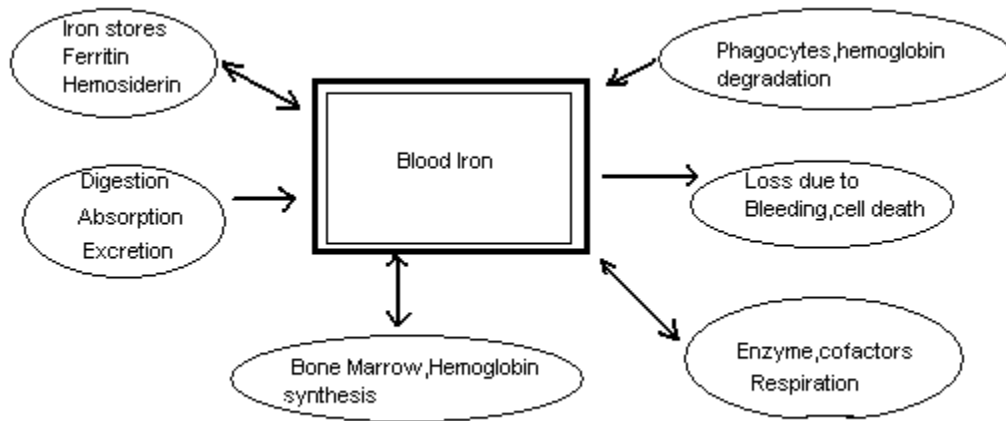

Fig 6.7. Homeostasis of Iron in blood

Causes of iron deficiency:

- Storage depletion
- Reduced dietary intake.
- Malnutrition
- Hemolysis
- Children who are on milk diet only are prone to iron deficiency.
- Chronic bleeding, irregular menstrual cycles
- Peptic ulcer, piles
- Hook worm infection
- Repeated malarial infections.

Deficiency leads to Iron deficiency anaemia or hypochromic microcytic anaemia.

It is associated with low hemoglobin and ferritin.

Copper

Humans contain around 100 mgs of copper. Liver, brain, kidney and heart are rich in copper. Free copper is 4%, 96 % is bound to Ceruloplasmin in body.

Sources: cereals, legumes, raisins, nuts etc

Functions:

- Cofactor of enzymes like cytochrome oxidase, dopamine decarboxylase, tyrosinase, Cyt.C oxidase and superoxide dismutase and monoamine oxidases are dependant on copper. Tyrosyl oxidase is important for collagen metabolism
- Ceruloplasmin (serum ferroxidase) catalyses Fe^{++} to Fe^{+++} , a pre requisite for the incorporation of iron into transferrin.

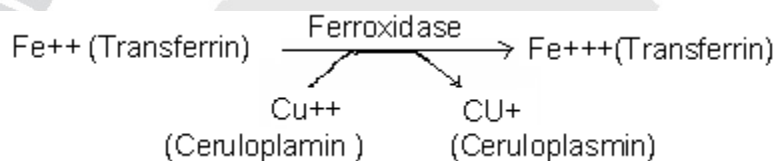

- Ceruloplasmin promotes iron absorption.

Copper deficiency:

- Causes anaemia. (Microcytic, normochromic anemia)
- Failure of melanin formation because tyrosine oxidase becomes inactive.

Menke's disease or Kinky hair syndrome:

It is fatal sex linked recessive disorder in which there is cerebral and cerebellar degeneration, connective tissue abnormalities and kinky hair.

- Both serum [Copper] and [Ceruloplasmin] is low.
- Absorption of copper from the intestine is grossly impaired, but treatment with parenteral copper has not proved successful.
- It is X- linked disorder. Patient has normal absorption of iron but transport across the serosal aspect of mucosal membrane is defective. Patient suffers from mental retardation.

Wilson's disease: It is an Autosomal, recessive disorder. There is a decrease in the biliary excretion of copper. Blood and tissue copper is high in these patients. It leads to retention of copper, followed by hepato-lenticular degeneration. However, Ceruloplasmin synthesis is incomplete in the liver. Patient suffers from progressive hepatic cirrhosis and finally liver failure.

There is dysfunction of lenticular region of brain

Defective tubular reabsorption in kidney leads to aminoacidurias.

Copper deposition in the eye, as golden brown or green ring around the cornea.

Patients are treated with Pencillamine, which binds to tissue copper and mobilizes it.

Magnesium:

It is an intracellular ion, essential for life.

Sources: Widely distributed in vegetables, chlorophyll, cereals, beans, potatoes, cheese and animal tissues.

Maximum concentration is found in bones, little in Extra-cellular fluid (ECF) and soft tissues.

2/3 in blood is in ionic form, rest is bound to protein.

It is absorbed from the small bowel.

It is excreted through feces, urine and sweat.

Functions:

- Role in enzyme action. It is a cofactor for peptidases, ribonucleases, glycolytic enzymes etc.
- Its action is similar to that of calcium in neuromuscular irritability.
- High levels depress nerve conduction, low levels may cause Tetany.
- Major part is found in bones. In teeth, it is present as dentin and enamel.
- Magnesium deficiency occurs rarely in man.

Fluorine

It is solely derived from water, tea, and fish

Daily intake should not be more than 3mg.

Excess is toxic, lethal dose is 2.5 Gms.

It is absorbed by diffusion from intestine.

Mostly it is found in the bones and teeth.

It is eliminated in the urine.

Functions:

- Fluorine is important for tooth development and prevention of Dental Caries.
- High consumption, leads to high concentration of Fluorine in enamel and dentine.
- It decreases calcium deposition.
- Teeth acquires mottling of enamel, teeth develop pits and discoloration.
- Bones contain traces of fluorine. Small quantities of it promotes bone development, increases retention of calcium and phosphate, prevent osteoporosis
- High level of fluoride in bone causes abnormal rise in calcium deposition, increases bone density

Fluorosis is due to toxicity of fluoride.

Excess can be due to high dietary intake, contaminated water or inhalation of fluorine.

- It damages mitochondria
- Inhibit enzymes which depend on Mg, like Succinic dehydrogenase.
- Protein synthesis decreases in muscle, heart, kidney, lungs, pancreas and spleen.
- Collagen synthesis is adversely affected.

Iodine

Sources: Vegetables, fruits obtained from sea shore, sea fish are rich in iodine. People who live on hills do not get iodine from diet. They are prone to suffer from deficiency.

It is absorbed from small intestines and transported as protein complex in plasma.

See the details of iodine metabolism, thyroid hormone synthesis from the chapter on hormones.

Zinc

Sources are liver, milk, fish, dairy products, cereals, legumes, pulses, oil seeds, yeast and spinach etc.

It is absorbed in duodenum and ileum. Absorption of Zinc from the intestine appear to be controlled in a manner similar to Iron. It is transported bound to a protein (α_2 -macroglobulin and transferrin)

It is excreted in urine and feces.

Diets rich in calcium, phosphates interfere with Zn absorption.

RDA is 15-20mgs for adult, 3-15mgs for infants and children

It is bound as complex of protein Metallothionein. The sulfur groups of the protein chelate zinc.

The body does not store Zinc to any appreciable extent in any organ, urinary excretion is fairly constant at 10 $\mu\text{mol/day}$.

Functions:

- Zinc is important for the activity of a number of enzymes like

Carbonic anhydrase

Alkaline phosphatase

Alcohol dehydrogenase

Porphobilinogen synthase

Leucine aminopeptidase

Carboxy peptidase

Aldolase in glycolysis

DNA, RNA polymerases as zinc has crucial role in DNA.

- Release of vitamin A from liver requires Zinc. Retene reductase (zinc enzyme) participates in the regeneration of rhodopsin (visual cycle).
- Insulin is secreted, stored as a complex of Zinc
- It is important for wound healing.

Deficiency of Zinc:

Patients requiring total parenteral nutrition, pregnancy, lactation, old age and alcoholics have been reported as being associated with increased incidence of Zinc deficiency.

It is usually associated with protein energy malnutrition (PEM)

It is caused by diuretics, chelating agents and anti-cancer drug treatment

- results in dwarfism and hypogonadism
- Delayed sexual development
- It decreases spermatogenesis in males and irregular menstrual cycles in females.
- It stimulates ribonuclease activity; thereby it affects the synthesis of mononucleotides and nucleic acids.
- Hepatosplenomegaly

- Severe Zinc deficiency can lead to a postular skin rash, loss of body hair, diarrhea and mood change.

Selenium

Selenium is rich in liver, kidney, finger nails. Usually plant products are good sources than animal based diet.

It is absorbed from duodenum, transported as selenomethionine. It forms a complex with plasma proteins for transport. In tissues, free selenium is released.

It is excreted in urine.

RDA 50-100 μg Adult

20-120 μg Children

Functions:

- Glutathione peroxidase is a selenium dependent enzyme. The enzyme has a role in oxidative damage by free radicals. The enzyme is critically important for the membrane stability of Red blood cells.
- Selenium has sparing action on vitamin E, by three ways.
 - It promotes digestion, absorption of lipids and vitamin E.
 - It is a part of glutathione peroxidase, prevents peroxidation of PUFA in the membranes. This in turn reduces the requirement of vitamin E.
 - It helps in the retention of vitamin E in the blood.
- It is a cofactor for an enzyme involved in the synthesis of thyroid hormone.

Deficiency of selenium:

- Liver cirrhosis
- Pancreatic degeneration
- Myopathy, infertility
- Failure of growth

Toxicity:

- Selenium toxicity is called Selenosis
- Toxic dose is 900micro gram/day
- It is present in metal polishes and anti-rust compounds

- The Toxicity symptoms are Hair loss, falling of nails, diarrhea, weight loss and gaslicky odour in breath (due to the presence of dimethyl selenide in expired air).

Halogenated aromatic hydrocarbons are useful in the treatment of Selenosis.



UNIT EIGHT

HORMONES

Objectives:

- To study the nature, types, general mechanism of action of hormones.
- To learn about the chemistry, synthesis, metabolic role of various hormones.
- To learn about the diseases associated with abnormal levels of hormones.

Introduction

Hormones are responsible for monitoring changes in the internal and external environment. They direct the body to make necessary adaptations to these environmental changes.

Hormones are also produced ectopically by malignant tumours. Tissue production (paracrine) of hormones is also possible

Hormones and Central nervous system interact to shape up development, physiology, behaviour and cognition. The actions and interactions of the endocrine and nervous system control the neurological activities as well as endocrine functions. The interaction is required for the cell to cell communication. A messenger secreted by neurons is neurotransmitter while the secretion of endocrine is called hormone.

Cellular functions are regulated by hormones, neurotransmitters and growth factors through their interaction with the receptors, located at the cell surface. Some hormones elicit hormonal cascade system. Part of chapter discusses receptors, signal transduction and second messenger pathways. Finally oncogenes and receptor functions is presented.

Both hyper and hypo-function of the endocrine glands produce distinct clinical symptoms. Clinical case histories are presented wherever needed. The basic information provides a solid foundation from which to view the existing and future developments in the rapidly moving discipline.

Definition

Hormones are chemical messengers secreted into blood by endocrine or ductless glands. However many hormones are secreted by organs which are not ductless glands. Hormone means to arouse or to excite.

Major endocrine glands are pituitary, hypothalamus, thyroid; adrenals, pancreas, ovaries and testes. Others are Thymus, Pineal gland and gastro intestinal hormones.

Hormones can be classified based on their structure, mechanism of action, based on their site of production etc.

Classification of hormones based on their structure.

1. Follicle stimulating hormone (FSH)	P	Adenohypophysis.
2. Leutinising hormone (LH)	P	“
3. Somatotrophin (GH)	P	“
4. Prolactin	P	“
5. Thyrotrophin (TSH)	P	“
6. Corticotrophin (ACTH)	PP	“
7. Vasopressin (ADH)	PP	Neurohypophysis.
8. Oxytocin	pp	“
9. Triiodothyronine (T3)	O	Thyroid.
10. Thyroxine (T4)	O	“
11. Calcitonin (CT)	PP	“
12. Parathyroid hormone (PTH)	PP	Parathyroid
13. 1, 25-Dihydroxy cholecalciferol	S	Kidneys.
14. Noradrenaline (Nadr)	O	Adrenal medulla.
15. Adrenalin (Adr)	O	
16. Aldosterone	S	Adrenal cortex
17. Cortisol	S	
18. 17- β -Estradiol	S	Gonads, Placenta
19. Progesterone	S	
20. Testosterone	S	Gonads.
21. Insulin	PP	Pancreatic Islets
22. Glucagon	PP	
23. Melatonin	O	Pineal Gland
24. Gastrin	PP	Stomach

Hormone	Action on pituitary
Thyrotropin releasing hormone, (TRH)	Acts on thyrotrope to release TSH
Gonadotropin releasing hormone,(GnRH)	Gonadotrope to release FSH, LH.
Growth hormone releasing hormone,(GRH)	Somatotrope to release GH
GH release inhibiting hormone/Somatostatin(GIH)	Somatotrope inhibits GH.
Corticotropin-releasing hormone, (CRH)	Corticotrope to release ACTH, α - lipotropin
Prolactin releasing factor(PRF)(dopamine)	Lactotrope to release PRL.
PRL release inhibiting factor	Lactotrope to inhibit release of PRL

PP=polypeptide, P=Protein, S = Steroid, O=Others

Table 7.1 Hormones (PP) of the Hypothalamus

Hormones reach target organs, exert their metabolic effects, also reach their site of production. Here, they inhibit the production of the hormone. This is called as feed back inhibition .Sometimes the concentration of the hormone is less, which stimulates the production of hormone by a process of feedback stimulation. (Fig 7.1) below

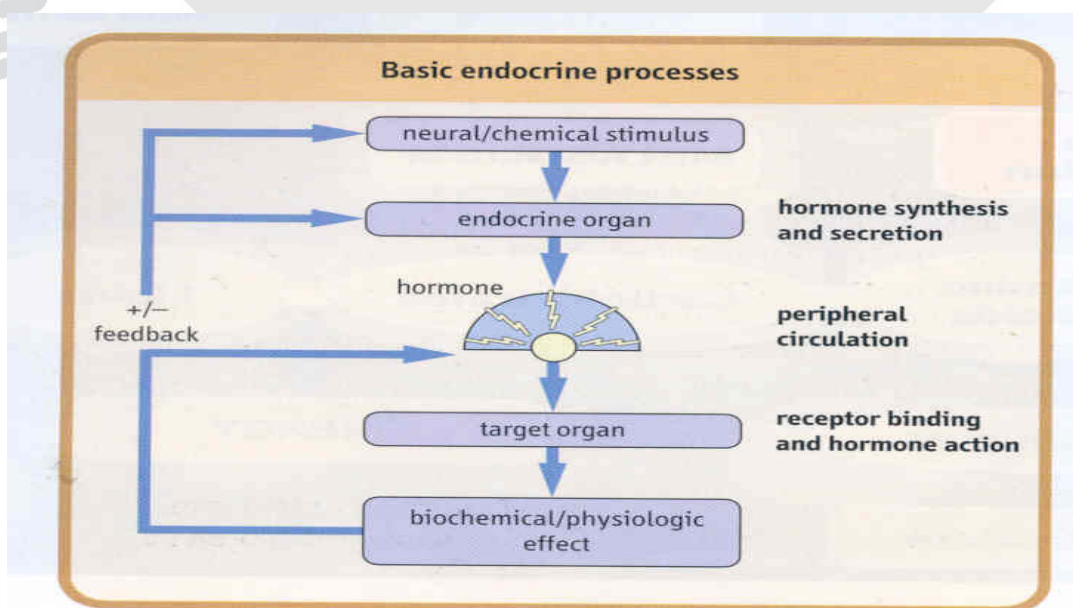

Fig.7.1.Basic endocrine processes.

Biosynthesis of Hormones

Biosynthetic mechanisms are many. Some protein hormones are synthesized as precursors, which are converted to active form by removal of certain peptide sequences.

E.g. Insulin is synthesized as pre-proinsulin (m.wt11500). Removal of some amino acids, peptides produce insulin (m.wt 5734).

Thyroxine, a single amino acid hormone. It is synthesized as a glycoprotein precursor called thyroglobulin, which has 115 amino acids.

Other hormones like glucocorticoids/ minerolacorticoids from Adrenal gland are synthesized and secreted in their final active form.

Pro-hormones: Some hormones are synthesized as biologically inactive or less active molecules called pro-hormones. Usually they are polypeptides/ proteins.

Eg. Pre-proinsulin → Proinsulin.

Storage

Hormones are stored in secretory granules within the cytoplasm of endocrine cells. eg. Thyroid hormones are stored in follicles filled with colloid particles. Catechoamines of Adrenal medulla are stored in secretory granules of cytoplasm.

- Storage always protects the molecule from untimely inactivation.
- Steroid hormones are not stored in significant quantities.
- In response to stimulus they are synthesized and released immediately.

Release:

- When the target cells require free hormones, they are released immediately.
- The deficit in the bound form is replaced by the secretion of the endocrine gland. Feed back inhibition/stimulation controls hormone release (Fig.7-1).
- Protein, polypeptide hormones are released by exocytosis or pinocytosis. It involves fusion of granules and cellular membrane, followed by secretion in to blood stream.
- Stimulus excites the endocrine cell.
- The specific enzymes in the storage vesicle activate the hormone before release.
- Disruption of the process by certain drugs interferes with exocytosis.
- The secretory process is linked to the release of neurotransmitters.

Transport:

- Some hormones are soluble and do not require transport proteins.
- Free hormone is the fraction available for binding to receptors and therefore represents the active form. Free Hormone concentration correlates best with the clinical status of either excess or deficit hormone.
- Steroid hormones are lipid soluble. They diffuse through cell membrane.
- Specific transport proteins are found in blood for carrying steroid hormones and thyroxine. Plasma globulins bind to thyroxine, cortisol and sex hormones. The binding is noncovalent type. Some hormones bind loosely to proteins like albumin for transport. Binding to plasma proteins protect them from inactivating systems.
- It also keep the hormones in readily available circulatory form to the target tissues.

Hormones and binding proteins

Hormone	Binding proteins.
Thyroxine (T3)	Thyroxine binding globulin (TBG), Thyroxine binding Pre-albumin (TBPA).
Aldosterone	Albumin
Estrogen	steroid hormone binding globulin (SHBG).
Testosterone	SHBG and Albumin.
Cortisol	Cortisol binding globulin (CBG).

Hormone action and Signal Transduction

Based on their mechanism of action, hormones are divided into two groups, steroid and peptide/protein hormones.

Mechanism of action of steroid hormones

- The group consists of sterol derived hormones which diffuse through cell membrane of target cells.
- The receptors for them are present in nucleus and cytoplasm.
- Hormone bind to receptor forms H-R complex which undergoes conformational changes (Fig.7-2).
- H-R complex is translocated to hormone response element (HRE) found on DNA.
- Subsequently mRNA is produced in large concentrations, which alters the synthesis of structural, enzymatic, carrier or receptor proteins. *Steroid hormones cause cellular effects through regulation of transcription.

- They also regulate post transcriptional processing of proteins.
- The transcription is accelerated producing more mRNA and proteins, enzymes and growth factors.
- Thus metabolic processes are affected.

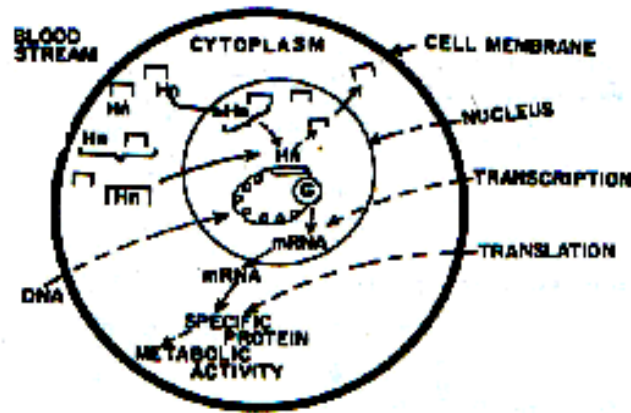



Fig.7.2.Mechanism of steroid hormone action

Hn: hormone, G:gene,  Carrier protein,  Receptor protein,
 HRE.  H-R Complex

Iodothyronine hormones:

- They are not steroid hormones
- Their action is similar to steroid hormones.
- They do not have cytoplasmic receptors.
- Certain high affinity receptors found in the nucleus.

Mechanism of action of Protein hormones:

- The group comprises the peptide/protein hormones.
- They can't enter target cells.
- They deliver message to the cell surface receptors.
- The receptors are integral glycoproteins with 3 functional domains.

- Extra cellular domain which binds to hormone
- Trans membrane domain penetrates lipid bilayer.
- Intracellular domain coupled with the effector system.

- * The hormone binds to surface receptors (SR) present on the plasma membrane of target cells.
- * The message is carried through cascade of protein-protein interactions.
- * Hormone is the first messenger. Then H-R complex sends signal across the membrane.
- * It elevates the concentration of intermediary molecules called second messengers.
- * These messengers act as signal conducting molecules and bring out the effects of a hormone. Second messengers are:-
 - * cAMP
 - Calcium
 - phosphatidyl inositol (PI)
 - diacyl glycerol (DAG).

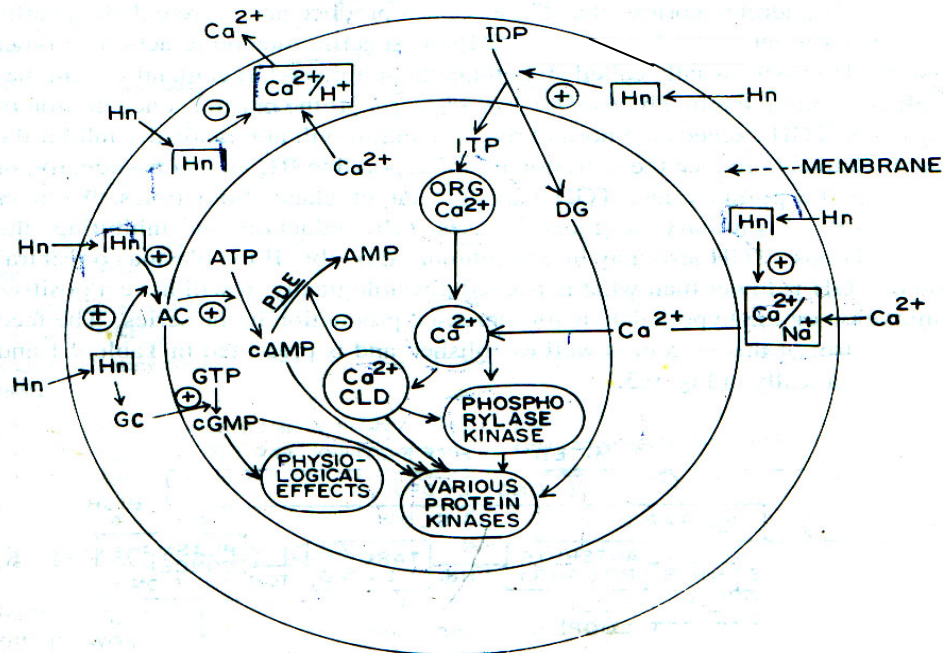

Fig.7.3. Mechanism of action of Protein Hormones:

Hn:Hormone, PDE: Phosphodiesterase:CLD:Calmodulin,AC:Adenylcyclase

IDP: Inositoldiphosphate, DG: Diacylglycerol, ITP: Inositoltriphosphate;

GC: Guanylate cyclase;  :receptor  H-R complex; +:Stimulation; - : Inhibition.

Binding of hormone to receptor leads to:

- Conformational change in the receptor and G-protein (α , β , γ subunits).
- It cleaves the trimeric form into activated α -GTP complex.
- G-protein is a peripheral protein; which diffuses along the inner surface of the plasma membrane to reach the effector protein.
- Through allosteric modification the message is conveyed to the effector protein.

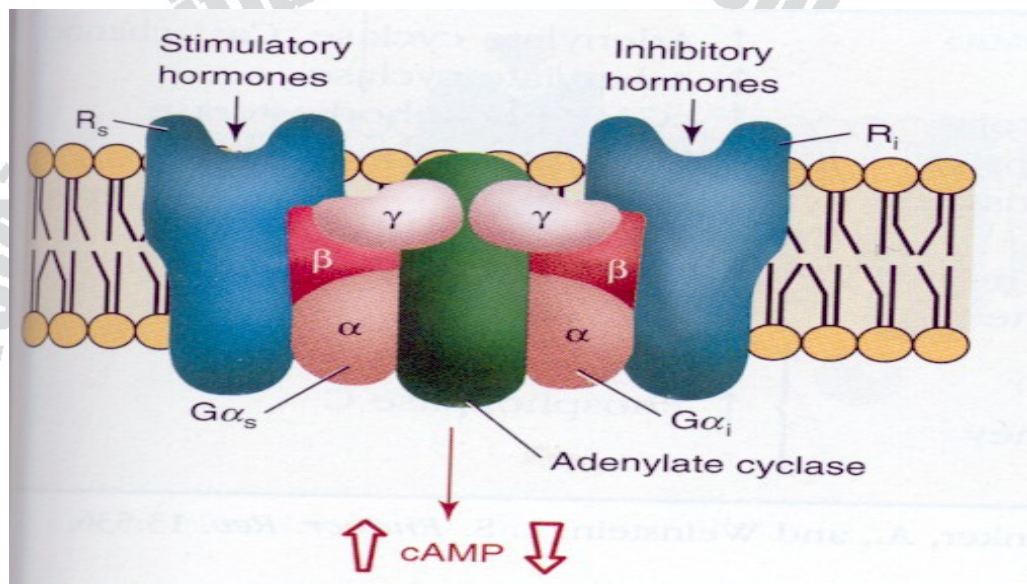

Fig.7.4.Receptor for protein hormone

RS= Hormone site for stimulation

RI= Hormone site of inhibition

- Effectors are intracellular enzymes like adenylate cyclase, phospholipase-C.
- On activation they produce second messengers like cAMP, phosphoinositides (Phosphatidyl Inositol) and diacylglycerol.
- cAMP is formed from ATP by adenyl cyclase action .
- In turn it activates protein kinase A which phosphorylates intracellular proteins.
- This leads to activation of key enzymes like glycogen synthetase, phosphorylase kinase, ultimately resulting in stimulation of glycolysis and inhibition of glycogenesis.
- Abnormalities in the hormone-Gprotein-adenyl cyclase axis may result in the impaired action of hormones. *On the other hand the inhibitory system comprises of receptors (R_i) and inhibitory regulatory complex (G_i).

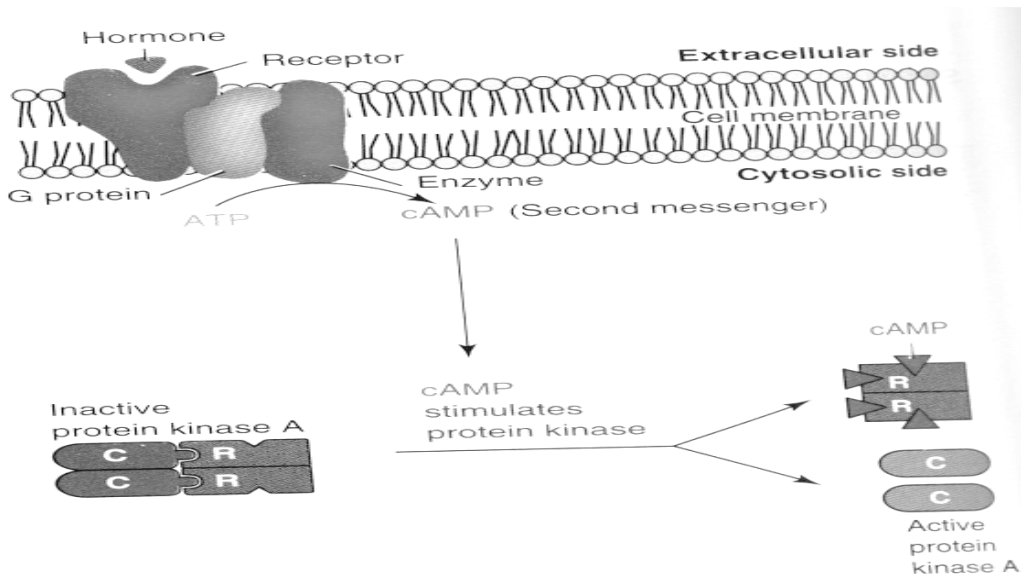

FIG.7.5. Regulation of adenylyl cyclase by α -sub units

c AMP binds to (R) of protein kinase A. Catalytic units (C) are released as active enzyme.

Receptors

Receptors are molecules which recognize specific hormone. Cell surface contains receptors for the peptide, protein, glycoprotein hormones. Lipophilic hormones like steroids, thyroxine are recognized by intracellular receptors, eg. Steroid receptor is in cytoplasm. It is a soluble oligomeric protein found in cytoplasm or nucleus. Thyroxine receptor is in nucleus (HRE). Lipid soluble hormones cross the cell membrane easily. Receptor binding to hormone involves electrostatic and hydrophobic interactions, and is usually reversible process. Binding influences effector molecule, cause several other molecular events.

Cytosolic receptors found for the following.

- Glucocorticoids.
- Mineralocorticoids
- Progestins.
- Estrogens.
- Calcitriol.

Nuclear receptors are identified for Thyroxine, Triiodothyronine.

Cell surface receptors with second messenger as c-AMP found for the following hormones.

ADH, HCG, LH, FSH, TSH, MSH, ACTH, CRH, Calcitonin, Glucagon,

Parathyroid hormone, somatostatin, angiotensin.

Regulation of receptors.

There are number of specific receptors in the target cells. Prolonged exposure to high concentration of hormone leads to decreased receptors, called as desensitization. There are two mechanisms for regulation.

Down regulation: There is internal distribution of receptors such that few receptors are available on the cell surface. This leads to decreased response in target tissue. More receptors reach cell membrane when the hormone concentration is low. Removal of receptor to the interior or cycling of membrane components alters the responsiveness to the hormone.eg. Insulin receptors can be shuttled between cytoplasm and cell membrane. In another type of down regulation, H-R complex, after reaching nucleus controls the synthesis of receptor molecule. Some times

Covalent modification of receptors by phosphorylation decreases binding to hormone, which diminishes signal transduction.

Up regulation: Some hormones like prolactin up regulate,(increase) their own receptors which ultimately increases the biological response and sensitivity in target tissues.

Receptors and diseases:

Abnormality in the receptors cause the following diseases.

Disease	Receptor	Defect
1. NIDM, Obesity.	Insulin.	Decreased receptors on target cells.
2. Myasthenia gravis.	Acetyl choline	Destruction by auto anti-bodies.
3. Asthama .	β adrenergic.	Ab blocks the site for receptor.
4. Acanthosis nigricans.	Insulin.	IgG blocks the H-R complex.
5. Graves disease.	TSH.	Ab produces desensitization
6. Vit.D resistant rickets.	Calcitriol .	Receptor deficiency.
7. Congenital nephrogenic Diabetes insipidus.	ADH.	Receptor defect.

Second messengers:

Second messengers: calcium, phosphatidyl inositols are identified for GnRH, TRH, Acetyl choline, Angiotensin-II, Vasopressin.

Insulin, GH, Prolactin, Oxytocin have unknown intracellular messengers.

Hormone itself is first messenger. The message is communicated to the cell via second messengers.

1. **Cyclic AMP as second messenger:** ATP is converted to cAMP by the effector protein, adenylyl cyclase. This enzyme is activated when hormone binds to receptors. The signal is transmitted through G protein called Gs. It is a trimer consisting of α , β and γ subunits. When H binds to receptor, there is GTP induced dissociation of the subunits, GTP binds to α -subunit.

α -GTP complex activates adenylyl cyclase; as a result cAMP is formed. This molecule mediates phosphorylation of intracellular proteins, by activating protein kinase A. As a result, there is increased glycogenolysis, inhibition of glycolysis occur. Protein kinase A is a tetramer having two regulatory units and two catalytic units (R_2C_2). In the absence of cAMP, R and C units are bound to each other. R unit can bind to 4 molecules of cAMP, undergoes conformational change. Then the two catalytic units are released in the active form (Fig.7-5) α -subunit of Gs has GTP hydrolyzing enzyme (GTPase) which converts α -GTP to α -GDP.

α -GDP is biologically inactive, can't stimulate adenylyl cyclase but reunites with the β , γ subunits to form a trimeric complex.

The inhibitory system consists of different receptors (R_i), and inhibition regulatory complex (G_i). It is a trimer consisting of α , β and γ subunits. When H binds to R_i , the complex is dissociated into α i-GTP + $\beta\gamma$. Adenylyl cyclase is inhibited by α , i-GTP, the concentration of cAMP decreases. Both Gs and G_i are targets of toxins.

Bacterial Toxins:

Vibrio cholerae produce enterotoxin which binds to ganglioside (Gm) from the intestinal mucosa. This causes ADP-ribosylation of α -subunit in Gs protein. Thus it retains the capacity to bind to GTP, and stimulate adenylyl cyclase. It loses its GTPase activity. So the α -subunits get trapped in the activated form permanently. Since it has lost its capacity to turn off, excessive c

AMP is generated. This causes profuse secretion of water and electrolytes, causing fatal diarrhea.

Pertussis toxin from *Bordetella pertussis* modifies α subunit of G_i , via ADP ribosylation. Consequently, G_i loses its capacity to inhibit adenylylase. The enzyme remains active permanently; produce large amounts of cAMP. Ultimate result of infection is Whooping cough.

2. Calcium, as second messenger:

Hormones exert their action via Ca, PI, or both (Fig.7-3). Intracellular Ca is increased by

- a) Entry of Ca from extra cellular region when stimulated.
- b) Inhibition of Ca pumps, which pumps out Ca ions in exchange for H ions.
- c) Release of Ca ions from intracellular resevoirs like mitochondria, endoplasmic reticulum.

3. **Phosphatidyl inositol 4, 5 bisphosphate.** Binding of hormone to receptor results in the cleavage of phosphatidyl inositol by phospholipase-c (PLC) to diacyl glycerol(DAG) and Inositol- 1, 4, 5, triphosphate (IP_3). Intracellular IP_3 releases Ca ions. A calcium binding protein, calmodulin binds Ca .The complex activates a number of intracellular enzymes.(Eg. Ca-calmodulin complex inhibits glycogenesis, stimulates glycogenolysis.)

Binding of Ca to calmodulin alters its conformation, which induces conformational change in the enzyme molecule.

4. **Diacyl glycerol (DAG)**, activates Ca-phospholipids dependent protein kinase which in turn phosphorylates several intracellular proteins. PKC has regulatory and catalytic domain. In the absence of DAG, Ca and phospholipids, there is interaction between regulatory and catalytic sites. This results in inactivation of the enzyme.

Maniac depression:

Patients who suffer from maniac depression are treated with Lithium. The disease is a result of high levels of hormone/ neurotransmitters, whose actions stimulate phosphatidyl inositol cycle. Lithium treatment interrupts the availability of PI_3 . The cells become less sensitive to hormonal and neurotransmitters stimuli.

INSULIN

Insulin is a protein hormone secreted by β -cells of Islets of Langerhans of pancreas.

Chemistry: It is composed of 2 polypeptide chains, A and B, containing total of 51 amino acids. A chain has 21 and B has 30 amino acids. The two chains are held together by disulfide linkages. If the disulfide bonds are broken the insulin molecule is inactivated.

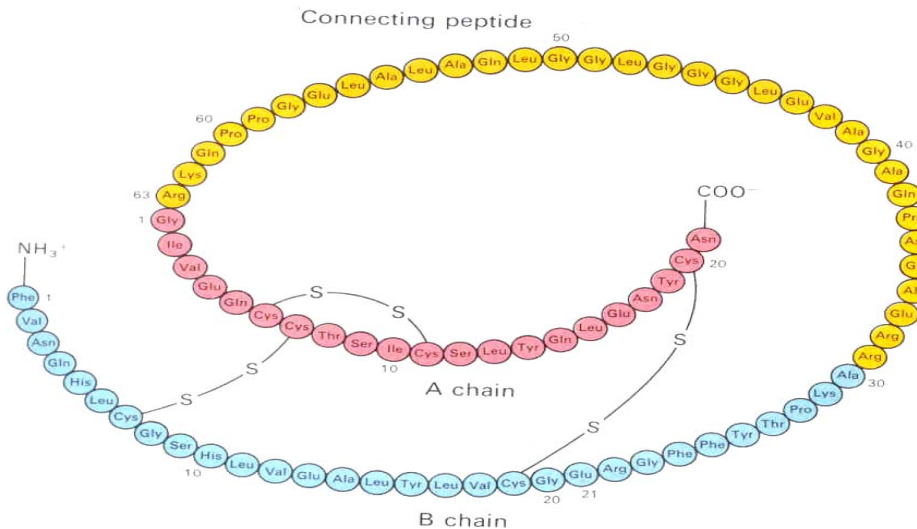

Fig.7.6. Structure of Insulin

C peptide=31-65, A chain=66-86, B chain=1-30

Porcine Insulin is similar to human insulin except Threonine is substituted by Alanine at 30 position of B chain. If alanine is removed then porcine insulin becomes less antigenic in humans.

Biosynthesis of Insulin

Pre-pro insulin (109 amino acids) is synthesized in the endoplasmic reticulum of B Cells of islet of Langerhans. It is acted up on signal peptidase, gets converted to proinsulin (86AA). It is transported to Golgi where it is hydrolyzed to insulin (51AA) by trypsin like protease and carboxy peptidase B. The process liberates inactive C-peptide of 31a.a and 4 other amino acids from the C-terminal. C-peptide determination in urine is related to the insulin out put from pancreas. It is used to differentiate endogenous to exogenous source of insulin.

Condensing vacuoles are pinched off from Golgi cisternae with equal quantities of insulin and C-peptide. Insulin is secreted via exocytosis. Insulin is biologically active, pro insulin is inactive.

Catabolism:

Plasma half life of insulin is 3 to 5 minutes. It is catabolised in liver, kidney and placenta.

- a. Liver, kidney contains protease which is specific for insulin degradation.
- b. Insulinase or Glutathione-insulin trans hydrogenase is located in liver, kidney, muscles and placenta. It causes reductive cleavage of S-S bonds.
- c. After the reductive cleavage, the A&B chains are hydrolyzed by proteolysis. Mechanism of insulin action

When insulin binds to specific receptor, several events take place.

- A. There is conformational change of the receptor.
 - B. The receptors crosslink and form micro aggregates.
 - C. The receptor complex is internalized.
 - D. One or more signals are generated; however the role of second messenger is uncertain.
1. Role of c AMP: Insulin promotes the hydrolysis of c AMP by phosphodiesterase. The result is decreased concentration of c AMP in the cells. The c AMP dependent protein kinase can't phosphorylate specific enzymes.
 2. Role of c GMP: Insulin receptor complex may activate guanylate cyclase, which forms c GMP. This acts as second messenger to activate c GMP dependent protein kinases.

These enzymes may phosphorylate some of the cytoplasmic proteins/ enzymes.

For details see mechanism of action of protein hormones.

Regulation of Insulin Receptors

High levels of insulin in blood decrease the insulin receptors on the target membrane. Here insulin-receptor complex is internalized, there by causing less sensitivity of target tissue. See down regulation.

Regulation of Insulin secretion:

Secretion of insulin is closely coordinated with the release by pancreatic α - cells. Insulin along with glucagon maintains glucose levels.

- a. Insulin secretion is increased by increase in glucose. B-cells of pancreas have sensors to glucose. High levels of glucose stimulate insulin secretion and decrease glucagon release.
- b. High levels of amino acids in the plasma induce the secretion of insulin.
- c. Gastrointestinal hormones like secretin and others are released in response to intake of food. They induce anticipatory secretion of insulin, before the rise of glucose in the portal vein. Therefore when glucose is given orally it induces more insulin secretion than when given intravenously.
- d. Glucose stimulates secretion of insulin and inhibits the release of glucagon.
- e. Synthesis, release of insulin is decreased when there is scarcity of dietary fuels.

Metabolic Role of Insulin

Carbohydrate metabolism: Insulin produces lowering of blood glucose and increases glycogen stores. This is achieved at several metabolic stages. *There is increased uptake of glucose, galactose by various tissues like muscles, adipose, mammary glands etc .It is due to increased translocation of glucose transporters from Golgi to plasma membrane.

- * Insulin induces the synthesis of glucokinase which phosphorylates and decreases the intracellular glucose in liver.
- * Insulin enhances glycolysis by inducing the synthesis of phosphofructokinase and pyruvate kinase.
- * Pyruvate dehydrogenase complex is activated via dephosphorylation of enzyme molecules which lead to increased production of acetyl- CoA from pyruvate.
- * Insulin stimulates protein phosphatase-1 which dephosphorylates and activates key enzyme glycogen synthase. This leads to increased synthesis of glycogen.
- * Insulin reduces gluconeogenesis by repressing at gene level, PEP (Phosphoenol pyruvate) carboxykinase, and it inhibits F-1, 6 bisphosphatase via F- 2, 6 bis phosphatase inhibition.

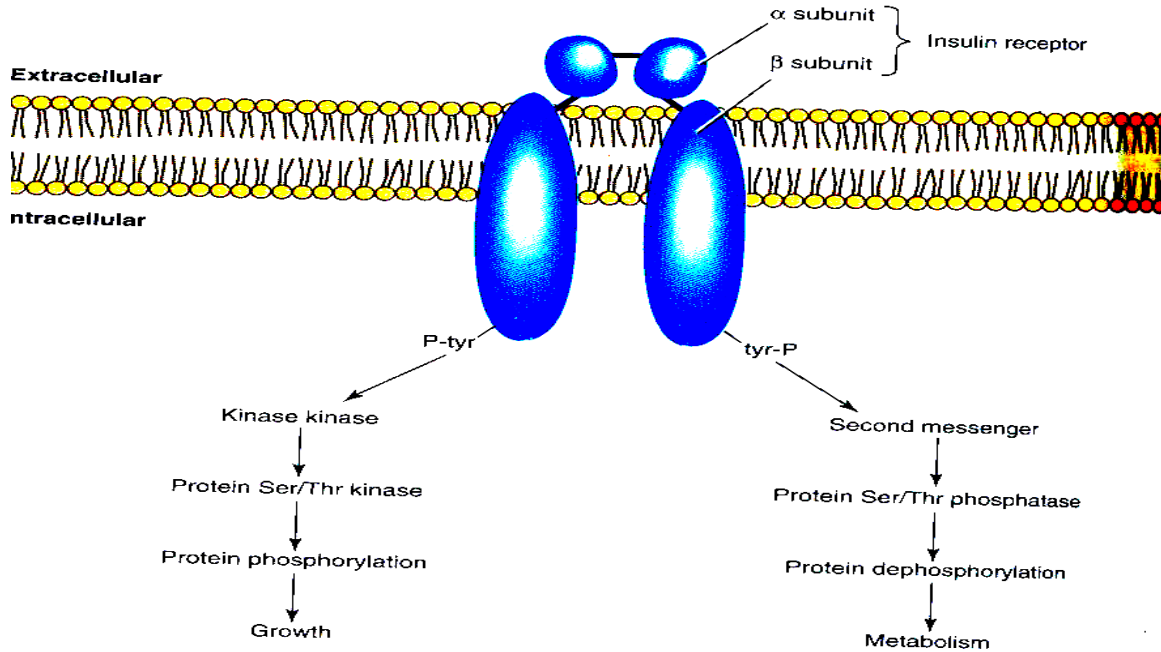

Fig.7.7. Paradoxical action of insulin

- * Insulin stimulates protein phosphatase-1 which dephosphorylates and activates key enzyme glycogen synthase. This leads to increased synthesis of glycogen.
- * Insulin reduces gluconeogenesis by repressing at gene level, PEP carboxykinase, and it inhibits F-1, 6 bisphosphatase via F-2, 6bis phosphatase inhibition.
- * Insulin decreases glycogenolysis by dephosphorylating glycogen phosphorylase (inactivate) and also repressing glucose - 6phosphatase.
- * It stimulates HMPshunt by inducing the enzymes glucose-6 phosphate dehydrogenase, 6-phosphogluconate dehydrogenase.

Lipid metabolism: Insulin causes lowering of free fatty acids level in blood and increases the stores of triacylglycerol.

- It decreases lipolysis by inactivating triacylglycerol lipase by dephosphorylation.
- It increases fatty synthesis by making available acetyl - CoA, and acetyl - CoA carboxylase.
- Triacylglycerol synthesis in the adipose tissue is increased by providing more of α -glycerophosphate from glycolysis. It also induces the synthesis of lipoprotein lipase

which releases more fatty acids from the circulating lipoproteins. This provides more acyl- CoA for TG synthesis.

Protein Metabolism:

Insulin promotes protein synthesis by:

- Increased uptake of amino acids through increased synthesis of amino acid transporters in the membrane
- Insulin effects gene transcription by increased levels of amino acids, regulates m-RNA synthesis and also translation.
- It increases the enzyme ornithine carboxylase thereby increases polyamine synthesis which is required for r-RNA synthesis.
- Insulin modulates ribosomal activity via phosphorylation of 6s-ribosome of 40s ribosome.

Growth & cell replication:

Insulin stimulates growth in vivo, It activates fibroblast growth factor (FGF), platelet derived growth factor (PDGF) and epidermal growth factor (EGF). net effect is cell proliferation and growth is seen in liver, mammary, adrenal tissue.

Diabetes mellitus

β -cells of islets of Langerhans fail to secrete adequate amounts of insulin or producing absolute or relatively low amounts of insulin. This causes hyperglycemia and glycosuria. The condition may be inherited as autosomal recessive trait.

It is a chronic disease of impaired carbohydrate metabolism. It is caused due to diminished effectiveness or deficiency of insulin. Secondary changes in the protein, lipid, water and electrolytes metabolism may also occur.

Diabetes mellitus (DM) is found usually after the age of 40 yrs. There are 22 clinical types of the disease.

- a. Primary (idiopathic). Though exact cause is not known, but an insufficient level of insulin is found in the patient. This forms a major group.
- b. Secondary constitutes a minor group where it can be secondary to other diseases.

Primary is of two clinical types:

Types of Diabetes:

Juvenile onset diabetes

(Insulin dependent DM)

Type-I, DDM.

1. Less common
2. Starts around 15 yrs of age
3. Onset sudden and rapid
4. Usually patients are thin, less body weight.
5. Progress is rapid, leads to ketosis.
6. Deficient in insulin. Initially patients Produce more insulin than normal Soon the β -cells gets exhausted, and atrophied and produce no insulin.
7. Plasma insulin is almost absent,
8. Insulin therapy is necessary.

Maturity onset diabetes.

Non Insulin Dependent DM

Type-II, NIDDM.

- More common.
- Starts after 40 yrs of age.
- Slow and progressive.
- Associated with obesity
- Ketosis is rare.
- B-cells respond normally however there is Relative deficiency of insulin- due to insulin antagonism.
- Plasma insulin levels may be- raised or normal
- Oral hypoglycemic agents and Dietary control is useful to the patients.

Insulin antagonism is found in maturity onset diabetes, the secretion of hormone is normal or more. The antagonism could be due to antibodies to insulin or the insulin molecule may be abnormal, less active or altered. It may also be due to insulin receptor deficiency; there can be lack of cellular response to insulin.

Secondary diabetes Mellitus is due to other diseases like pancreatitis, malignancy of pancreas, hemochromatosis. All the three conditions leading to diabetes called as pancreatic diabetes. Elevated levels of antagonistic hormones also can cause secondary diabetes.

Eg. Hypothyroidism, Cushing syndrome, hyper pituitarism, and increased glucagon activity.

Presentation of diabetes:

- A. Glycosuria. Without signs and symptoms, glucose may be detected in the urine of the patient.
- B. Patient may also present classical symptoms like polyuria, polydipsia, and polyphasia, accompanied by loss of weight.

(Polyuria: Large amounts of glucose may be excreted diuresis, causing excretion of large quantities of urine. Polydipsia: Loss of fluid lead to excessive thirst. Polyphagia: Intake of food is more and craving for sweets is common.) Tissues get enough supply of glucose but can't utilize. This leads to weakness.

- C. Some women may present symptoms during pregnancy (stress).
- D. Patient derives energy from the break down of free fatty acids. Increased cholesterol synthesis in these patients may lead to atherosclerosis.
- E. Patient suffers from increased break down of tissue proteins, which accounts for loss of weight.
- F. Increased breakdown of fatty acids lead to ketosis, Diabetic Keto acidosis and hyperventilation. If not treated, patient will slip in to coma and die.

Chronic complications of diabetes:

- Uncontrolled diabetic patients develop cataract. It is related to hyper glycaemia. There is glycosylation of lense proteins or Glucose gets metabolized to sorbitol in the lense. The associated osmotic changes ultimately result in fibrosis and cataract formation.
- Diabetic damage of kidney is called diabetic nephropathy. It manifests initially as proteinuria, subsequently renal failure.
- Neurological complications like itching, neurodermatitis is common.

Hyper-insulinism

It means increased insulin production. Usually it is due to adenoma of islets of Langerhans. Occasionally they become malignant and metastasize all over the body. There is tremendous production of insulin. Since hypoglycemia is a serious possibility in these patients, they are protected by giving orally more than 1000gms of glucose/day.

Glucagon

It is produced by α -cells of islets of Langerhans of pancreas. It is also called as hyperglycemic glycogenolytic factor (HGF). It acts as a hormone and is required to mobilize metabolic substrates from the storage depots.

Chemistry: It is a polypeptide with 29 aminoacids. There are 15 different amino acids in the molecule. Histidine at N-terminal, Threonine at C-terminal end.

Synthesis: It is synthesized as pro-glucagon in α -cells. Carboxy peptidase B, trypsin like peptidase in the lysosomes of α -cells, hydrolyze it to produce active glucagon and some inactive peptides.

Role of glucagon:

- * Carbohydrate metabolism:
- * It increases glucose by Glycogenolysis in liver. It has no effect on muscle due to the absence of receptor. It induces synthesis of glucose-6 phosphatase.
- * It increases gluconeogenesis in liver by inducing the synthesis of key enzymes. Enzymes like PEP carboxy kinase, pyruvate carboxylase, F-1, 6-bisphosphatase are synthesized to promote gluconeogenesis.
- * The hormone promotes protein break down in liver to supply glucogenic amino acids.

Lipid metabolism: It promotes lipolysis of Triacyl glycerol in liver.

- * Promotes β - oxidation of Fatty acids in adipose tissue.
- * It decreases fatty acid synthesis by inactivating acetyl - CoA carboxylase.

Protein metabolism:

- * It depresses protein synthesis.
- * It promotes breakdown of proteins in liver.

Effect on mineral metabolism:

- It increases potassium, and calcitonin release which in turn causes calcium lowering effect.

Clinical aspects.

- * Glucagon is used in the treatment of insulin induced hypoglycemia.
- * Long acting Zn-glucagon is used in inoperable tumors of pancreas.
- * It is used in acute pancreatitis for, it inhibits excessive secretion of pancreas.

Thyroxine

Follicular cells of thyroid produce T₄ (thyroxine) and T₃ (triiodothyronine). Para follicular cells of thyroid produce calcitonin. T₃, T₄ are iodinated amino acids of tyrosine, and are synthesized from thyroglobulin and iodine.

Thyroglobulin is a dimeric glycoprotein with two protein chains. There are 115 tyrosine residues in each molecule. A large part (70%) of iodine in thyroglobulin exists as inactive monoiodotyrosine, diiodotyrosine and rest is in the form of T₃, T₄. If iodine content is normal, the ratio of T₃ to T₄ is 7:1. In case of iodine deficiency, the ratio decreases. T₃, T₄ are stored in the thyroglobulin. The peptide bonds are broken before they are released into capillaries.

Synthesis of Thyroglobulin:

- * The acinar cells of thyroid synthesize and store thyroglobulin as colloid in follicles.
- * They also collect (iodine trap) and transport iodine for the synthesis of hormone.
- * They help in the secretion of T₃, T₄ into circulation.
- * Thyroglobulins are packed into vesicles and pinched off from Golgi cisternae.
- * These vesicles fuse with plasma membrane release their contents into the colloid of thyroid follicles.

Dietary iodine comes from vegetables, fruits, grown on sea shore. Sea fish is very rich in iodine. Total iodine in the body is 50 mgs and only 10-15mgs is in the thyroid. Daily requirement is 100-200µg. In the kidneys 97% of filtered iodine is reabsorbed.

Thyroid concentrates iodine from circulation and transports to colloid. The required transporter pump is located on the plasma membrane which works along with sodium pump. The activity of the pump is stimulated by TSH. The iodine pool in acinar cells exists as exchangeable iodide in blood and unused iodine as iodotyrosine.

Oxidation of iodine is carried out by thyroperoxidase. The enzyme binds iodide to thyroglobulin at specific sites on the molecule. The iodine is added to the 3rd position of aromatic ring in tyrosine. It forms monoiodotyrosine (MIT) then it is iodinated at 5th position to form diiodotyrosine (DIT).

When 2 molecules of DIT undergo oxidative condensation in the presence of thyroperoxidases, T_4 is synthesized. The liberated iodine from thyroglobulin is reutilized. De-iodination converts T_4 to T_3 in other organs than thyroid.

TSH stimulates the synthesis of thyroglobulin and thyroxine.

T_3 , T_4 :

- * 80 % of T_4 is converted to T_3 .
- * T_3 loosely bound to the serum proteins.
- * T_3 is more active than T_4 .
- * T_3 has rapid onset of action.
- * It is more rapidly degraded in the body.
- * T_3 binds to thyroxine receptors in target tissues with higher affinity than T_4 .
- * Only free T_3 , T_4 are the metabolically active hormones in plasma.

T_3 appears to be the major thyroid hormone metabolically.

Mechanism of action of thyroid hormone:

Targets are liver, kidneys, adipose, cardiac, neurons, and lymphocytes.etc.

Nucleus has receptors for the T_3 and T_4 , when the hormone binds to them.

- * It increases the gene transcription, and produce more proteins and enzymes.
- * The hormone promotes protein synthesis.

Metabolic role:

- * It favors protein anabolism and stimulates growth in children.
- * The hormone increases glucose utilization and cholesterol , phospholipid synthesis.
- * Thyroxine produces more heat by increasing O_2 consumption. Thus basal metabolic rate (BMR) is increased.
- * Conversion of carotene to Vit.A requires thyroxine. Thus in hypothyroidism, there is accumulation carotene in blood which is responsible for the yellowish tint of the skin.

Hyperthyroidism: There is excess of T_3 , T_4 due to enlarged thyroid, toxic goiter, thyrotoxicosis. In most cases, it could be due to Graves disease, which results from the over production of thyroid stimulating immunoglobulin (TSI). Antibodies are developed against thyroid due to autoimmunity.

Here the size of the gland is 2-3 times more than normal. Each follicular cell secretes thyroxine by several fold.

Symptoms:

- Patient has protrusion of eye balls; in a condition called exophthalmoses. Eyeballs undergo edematous swelling.
- Patient suffers from rapid heart rate, increased BMR, loss of weight, and has marked nervous excitability, increased sensitivity to heat.
- Excessive sweating is common.
- Hyper glycemia, glucosuria and reduced glucose tolerance due to increased absorption of carbohydrate from intestine. Hyperthyroidism is treated with radioactive isotope like I^{131} or anti thyroid drugs improve the condition of the patient.

Anti thyroid drugs inhibit thyroid function by:

1. Interfering 'iodide trapping'
2. Inhibiting iodination and coupling during synthesis of hormone.
3. Inhibiting hormone release.
4. Inhibiting conversion of T_4 to T_3 in target tissues.

Hypothyroidism: Occurs due to insufficient free T_3 or T_4 , mainly because of thyroid failure. It could be due to diseases of pituitary, hypothalamus or autoimmunity.

- Patient has decreased BMR.
- Body temperature below normal.
- Heart rate is decreased, sluggish behaviour.
- In children it causes cretinism and in adults it causes myxedema.

Cretinism, is due to failure of growth and mental retardation. Cretinic child has congenital defects like short stature and stunted growth. It can be due to congenital absence of thyroid gland or from lack of iodine in the diet.

Goitre: It means enlarged thyroid gland. When there is iodine deficiency in the diet, patient develops endemic goitre. Iodine deficiency prevents the production of T_3 , T_4 but does not stop production of thyroglobulin. So TSH is released in large quantities, which in turn stimulates secretion of thyroglobulin in to colloid of follicular cells. So the gland enlarges 20 times to that of normal.

Symptoms:

- Sleeping for long hours .
- Muscular sluggishness.
- Increased body weight, mental sluggishness, husky voice, scaly skin.
- The patient develops nonpitting, edema all over body, in a condition called Myxedema. There is increased level of hyaluronic acid and chondroitin sulfate bound to protein, which forms excessive tissue gel in the interstitial spaces.
- Symptoms of this condition are progressive mental retardation, slowing of body processes, weight gain, thinning of hair and swelling of tongue. Endemic goitre is treated with supplementation of diet with iodized salt. Simple goitre (deficiency of Iodine) may be treated with exogenous thyroid hormones.

Catecholamines

Synthesis: Epinephrine is synthesized, stored in adrenal medulla while nor- epinephrine is synthesized in sympathetic nervous system. They act as neurotransmitters. A small concentration is synthesized, stored in adrenal medulla. These two hormones are synthesized in Pheochromomcytes or neuroglial cells, from tyrosine. See the details of synthesis from amino acid chapter.

Both the hormones are stored as chromofin granules in adrenal medulla. In nerve tissue only nor- epinephrine is produced.

Since catecholamines can't cross blood -brain barrier, brain synthesizes its own nor epinephrine.

Mechanism of action:

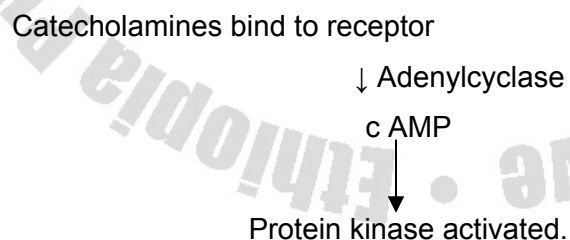

Protein kinase phosphorylates enzymes/proteins and either activate or inactivate them.

Metabolic role:

- In liver epinephrine stimulates glycogenolysis via c AMP, & increases Calcium levels.
- Norepinephrine has no effect on blood glucose, lactic acid levels. Glycogenolysis is increased in muscle by epinephrine.
- The same increases cardiac output, & glycogenesis in heart muscle. * Both the hormones promote lipolysis via c AMP.
- Epinephrine has inhibitory effect on insulin release.
- Both hormones promote metabolic rate through cutaneous vasoconstriction, which decreases heat loss and increases body temperature and muscular activity.

Pheochromocytoma:

It is caused by Chromofin tissue tumors in the adrenal medulla. In this condition both the hormones are increased.

Symptoms are:

- Paroxysmal hypertension.
- Elevated BMR.
- Hyperglycemia.
- Elevated free fatty acids in plasma.

Degradation: Catecholamines are degraded by Monoamine oxidases. The corresponding aldehyde products are oxidized to acids and excreted in the urine as vanillyl mandelic acid (VMA), metanephrine and normetanephrine.

Urinary metabolites of epinephrine and nor-epinephrine are estimated for the confirmation of diagnosis.

Case histories

Case I

Ten years old with bulging eye balls went for a medical checkup. He complained of swelling in the neck for the last three months. His eyes became prominent but the vision was normal. He also complained of weight loss and increase hunger. He is nervous, emotionally labile, very thin, and have frequent bowel movements. He suffered from excessive sweating, cardiac rhythms showed disturbances.

On examination, his eye balls were bulged, blinking was infrequent. Heart rate was rapid at 140/min, pulse irregular. Thyroid was enlarged by three times to that of normal.

Lab Investigations	Result	Reference Range
SerumT ₃	260µg/100ml	70-180 µg/100ml
SerumT ₄	18.1 µg/100ml	5.5-12 µg/100ml
Serum TSH	15.1U/L	5.7U/L
Serum cholesterol	161mg/dl	150-250mg/dl
Plasma Glucose	78mg/dl	<100mg/dl

Pituitary was found normal.

Q. What is the likely diagnosis?

Ans. It is a classical picture of Thyrotoxicosis. It is conformed by very high levels of T₄ .However there is elevated levels of TSH in spite of high thyroxin. The reason could be excessive TSH secretion by pituitary tumor. MRI investigations excluded this possibility. It could be due to loss of feed back sensitivity of pituitary to Thyroid hormones. Thus failure of feed-back inhibition of anterior pituitary by thyroid hormone is the pathological basis of the patient's condition.

Exercises

Q1. Why, an obese diabetic gets benefited by weight reduction?

Ans. Obesity and insulin receptors: Fat people have more of adipocytes. They contain fewer insulin receptors, thus respond poorly to insulin. Obese patients will respond well to restricted diet. Reduction to ideal body weight is the most important aim of nutritional therapy. Weight reduction lead to increased number of receptors per cell.

Q2. Following a normal overnight fast and a cup of black coffee, a diabetic woman feels slightly nauseous and decides to skip breakfast. As per schedule, she decided to lake her insulin shot what is the result of her action?

Ans. Patient of IDDM, improves by insulin treatment. It controls hyper glycemia and glucosuria. Insulin should be given only when blood glucose level can be maintained by dietary or stored glycogen. When blood glucose is low, if insulin is given, severe hypoglycemia might result, further it can lead to insulin shock. Hypoglycemia of 20mg% or less than that deprives brain from glucose. Patient will suffer from convulsions. In the present case, patient has not taken breakfast, insulin shot might result in hypoglycemia.

Ingestion of sugar will prevent serious consequences. If insulin shock occurs, then administration of intravenous glucose will save the patient.

UNIT NINE

MOLECULAR GENETICS

INTRODUCTION

This subject teaches us that the genetic information is stored in DNA or RNA (RNA viruses). And it teaches us the central dogma; that is the flow of genetic information from DNA to DNA from DNA to RNA, and then to protein.

NUCLEIC ACIDS

Nucleic acids are present in nucleus and Mitochondria

They are found in two basic structural forms, deoxyribonucleic acid (DNA) and ribonucleic acid (RNA).

THE STRUCTURE OF DNA

Deoxyribonucleic acid (DNA) is polymers of deoxyribonucleotides attached to each other by phosphodiester linkages. Each deoxyribonucleotide is composed of deoxyribonucleoside & inorganic phosphate group. Each deoxyribonucleoside is composed of nitrogen bases and a sugar deoxyribose. The nitrogenous bases are purines and pyrimidines.

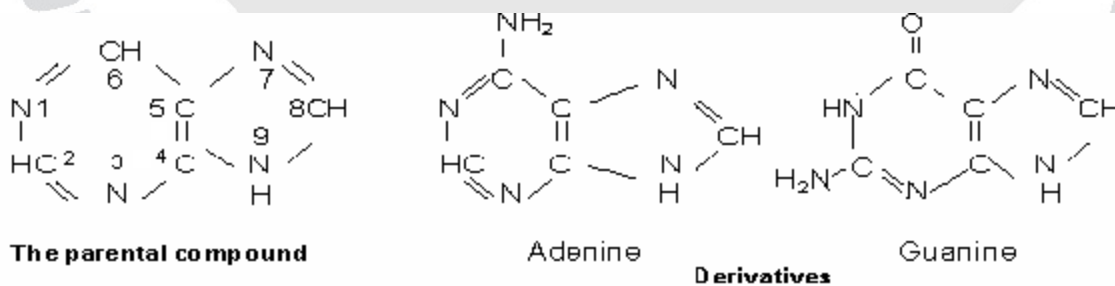

Fig 8.1 Purine bases

The two purine bases are adenine and guanine. They are derived from their parental compound.

The three pyrimidine bases are cytosine, thymine and uracil. It is important to know that thymine is found in DNA and uracil is found in RNA but the other above mentioned bases are found in both DNA and RNA.

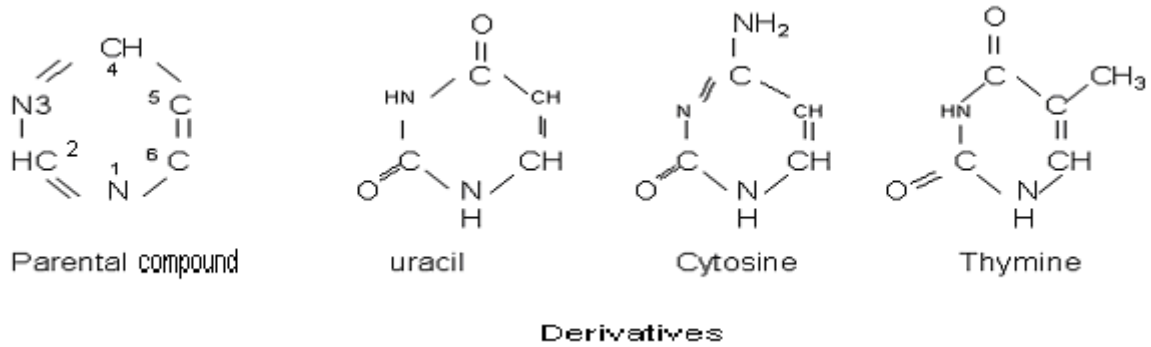

Fig 8.2 Pyrimidine bases

The linkage in purine nucleotide is between 1 of sugar ribose and 9 of purine bases.

The linkage in pyrimidine nucleotide is between 1 of sugar ribose and 1 of pyrimidine bases.

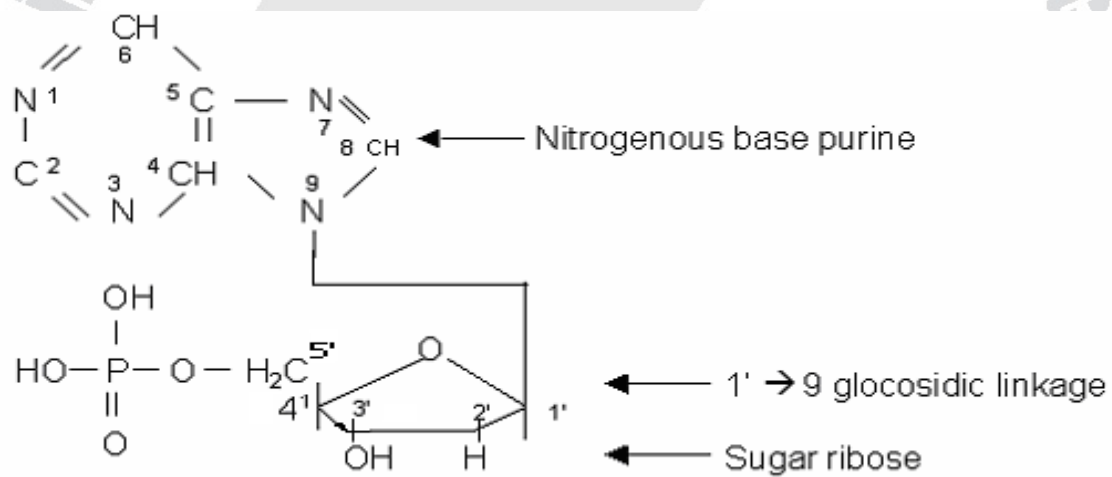

Fig 8.3 Purine deoxyribonucleotide

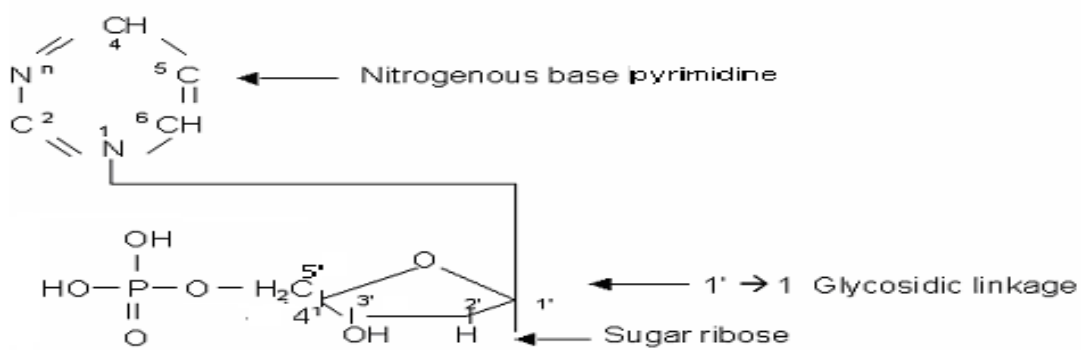

Fig 8.4 Pyrimidine deoxyribonucleotide

N.B. Nitrogenous bases + Pentose = Nucleosides

Nucleoside + Pi = Nucleotides. These are important biomolecules, central to maintenance & propagation of life.

1. ATP, GTP, CTP, UTP, NAD, FAD and CoA are important ribonucleotides which act as coenzymes.
2. Deoxyribonucleotides are required for DNA replication and repair. Ribonucleotides are required for RNA.
3. They are used in biosynthetic reactions like UDP-glucose, in glycogen synthesis and UDP-galactose in lactose synthesis.
4. ATP acts as currency of free energy for all cellular activities like muscle contraction, biosynthesis of molecules and transfer reactions.
5. Some nucleotides act as intracellular messenger's .eg, c AMP, c GMP are involved in peptide hormone action
6. GTP is used in protein synthesis.
7. S-adenosyl methionine participates in transmethylation reactions.

F. Primary Structure of DNA

The deoxyribonucleotides are linked together by phosphodiester bonds between the 3' – hydroxyl of the sugar of one nucleotide through a phosphate molecule to the 5' – hydroxyl on the sugar of another nucleotide. The sugar – phosphate linkages form the backbone of the polymer to which the variable bases are attached. The nucleotide polymer has a free phosphate group attached to 5' – position of sugar and a free 3' – hydroxyl group. The sequence of the polymer is written in the 5' to 3' direction with abbreviations to different bases e.g. GCAT bases as shown in the Fig.8.5

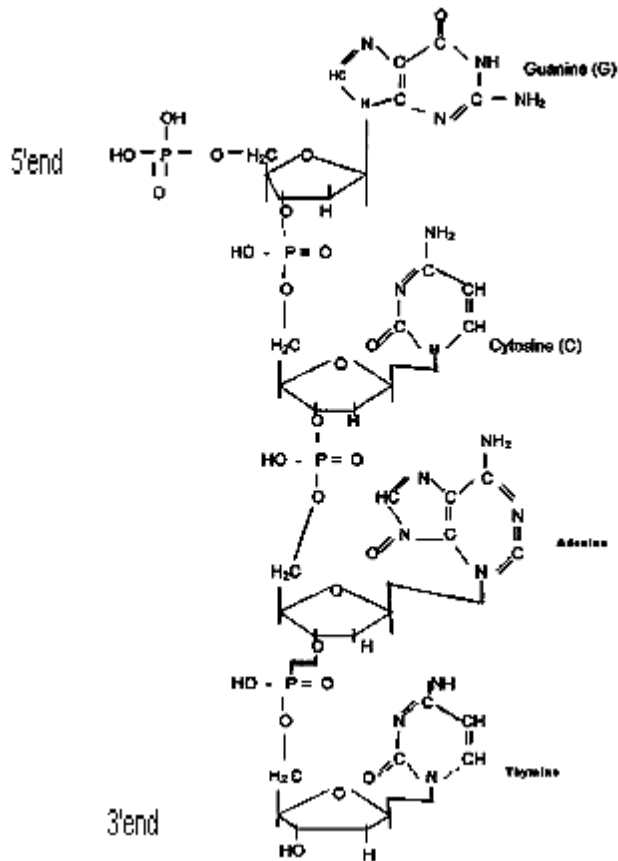

Fig 8.5 primary structure of DNA

Secondary Structure of DNA

The secondary structure of DNA is performed when the two strands of DNA are paired together as it is illustrated in the figure below. In the secondary structure of DNA, the two strands are anti-parallel. That means, the 5' ---- 3' of one strand is in opposite direction to the other strand. The bases are stacked in the inside of the two strands. The bases of one strand pairs with the bases of the other strand of the same plane such that adenine always pairs with thymine with two bonds. Guanine always pairs with cytosine with three bonds. The negatively charged phosphate group and the sugar units expose themselves to the outside of the chain. The two strands of DNA coil around a single axis forming right handed double helix.

Watson - Crick have proposed a double helical model of DNA, having the following important characteristic features.

1. Two helical polynucleotide chains are coiled around a common axis. The chains run in opposite directions, (anti parallel)
2. The two antiparallel polynucleotide chains are not identical, but they are complimentary.
3. The purine, pyrimidine bases are on the inside of the helix, the phosphate and deoxyribose groups are on the outside. The planes of the sugars are at right angles to that of the bases.
4. The diameter of the helix is 20 \AA , adjacent bases are separated by 3.4 \AA
5. The helical structure repeats after 10 residues on each chain.
6. The two chains are held together by hydrogen bonds between pairs of bases. Adenine is always paired with thymine, Guanine always paired with cytosine. A to T is bonded by two hydrogen bonds ($A \equiv T$), Guanine is bonded to cytosine by three hydrogen bonds ($G \equiv T$).
7. The double helix is stabilized by interaction between stacked bases of the same strand.
8. Watson - Crick Model of DNA is also referred as B-DNA, which is the most stable one under physiological conditions.

The mitochondrial DNA is circular and there can be formation of Z-DNA and C-DNA which can be performed during either replication or transcription.

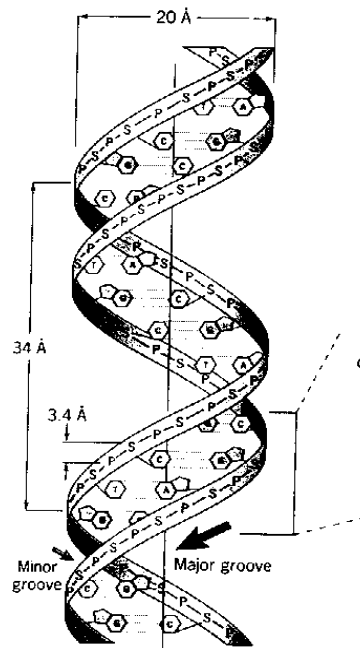

Fig 8.6 secondary structure of DNA

The Structure of RNA

The building unit of RNA is ribonucleotide. Ribonucleotide differs from deoxyribonucleotide in that ribonucleotide contains “O” in the carbon 2’ sugar ribose.

Uracil is found in RNA while Thymine is found in DNA.

The nuclear DNA is in secondary structure, but RNA is the primary structure. Only t-RNA after post transcriptional process can be changed to tertiary structure.

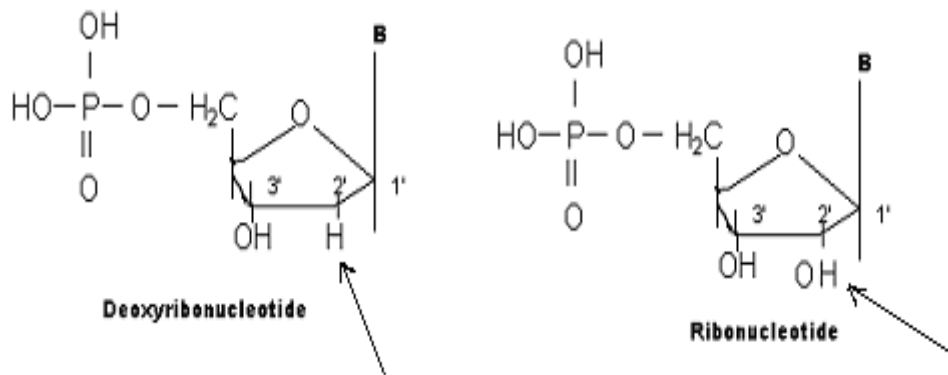

Fig 8.7 structure of Ribose and Deoxy-ribose in nucleotides

Differences between RNA and DNA

Both have adenine, guanine and cytosine. Both have nucleotides linked by phosphodiester bond, in 3’-5’direction. Both have important role in protein synthesis.

	DNA	RNA
1. Uracil	absent	Present
2. Sugar	Deoxyribose	Ribose
3. Site	Nucleus, mitochondria but never in cytosol	Nucleus, ribosome, cytosol, Nucleolus, mitochondria
4. Strands	Two helical strands	Single strand
5. Types	Major forms are A,B &Z hn RNA,& sn RNA.	t-RNA ,m-RNA, r- RNA, hn RNA, sn RNA .
6. Carries genetic information	-	Only m-RNA carries genetic information

7. DNA can synthesize RNA by transcription		Usually RNA can't form DNA, except by reverse transcriptase.
8. Number of Bases	equal	Not equal
9. Thymine	Present	Absent

The three RNAs that have important role in protein synthesis are:

1. Messenger RNA (mRNA)
2. Transfer RNA (tRNA)
3. Ribosomal RNA (rRNA)

Messenger RNA (mRNA)

mRNA in all eukaryotic cells contain cap at the 5' end of the chain. Cap characterizes 7-methylated guanosine tri phosphate. These mRNAs contain poly-A at 3'- end of the chain. Poly-A characterizes about 200 successive adenylate residues. It is illustrated on the given diagram. Poly-A also serves to protect the mRNA from exonuclease attack.

Serves for the transport of the mRNA from nucleus to cytosol. Cap is for the protection of DNA from exonuclease attack.

It is also used for the recognition during protein synthesis

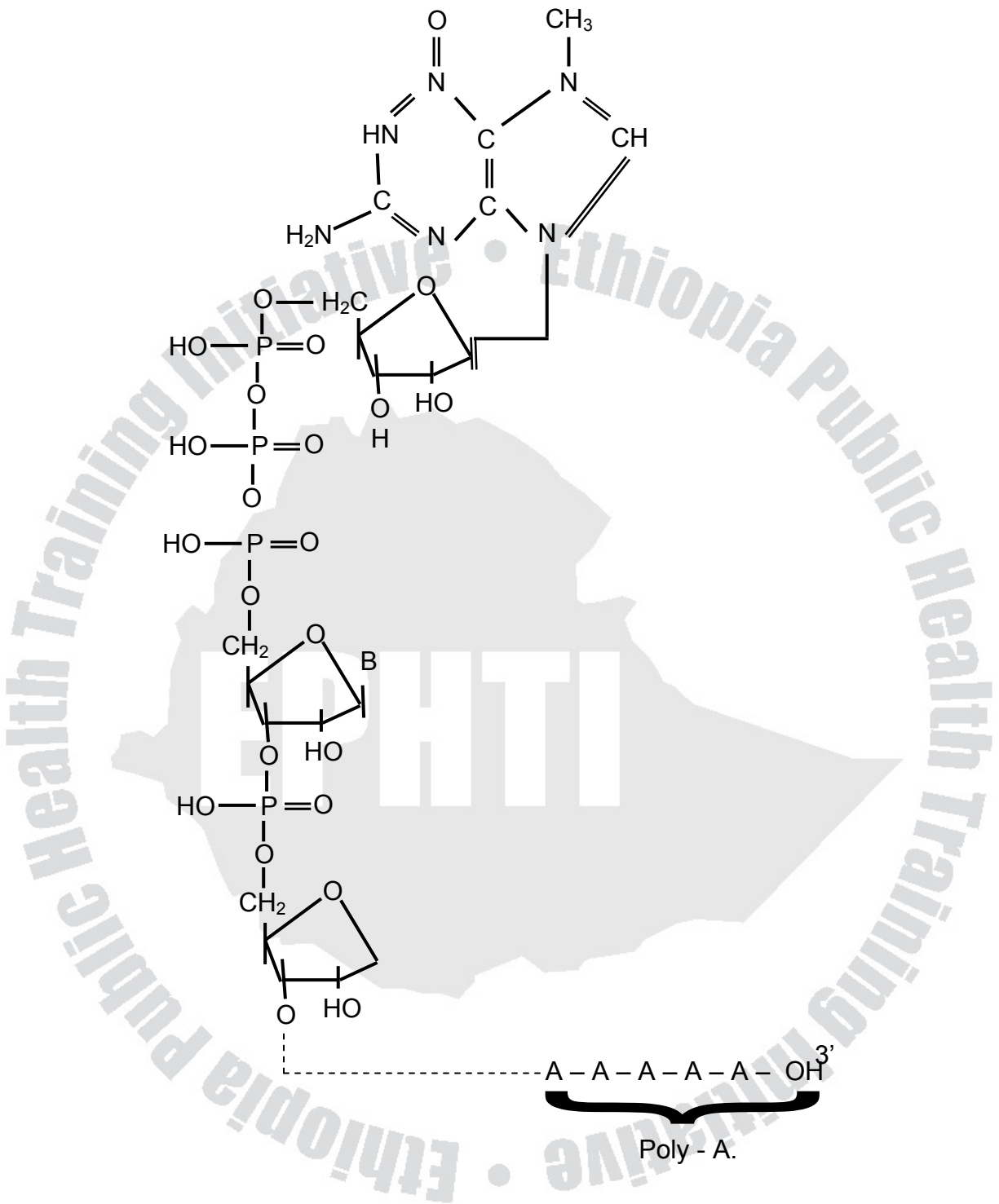

Fig.8.8 Messenger RNA (mRNA)

Transfer RNA (tRNA)

All tRNA have 4 arms.

1. Amino acid arm: the one that carries amino acid
2. DHU arm: the one that binds with active center of the enzyme aminoacyl tRNA synthetase.
3. T ψ C arm: the one that binds to ribosome during protein synthesis.
4. Anticodon arm: which pairs with the codon of mRNA during protein synthesis.

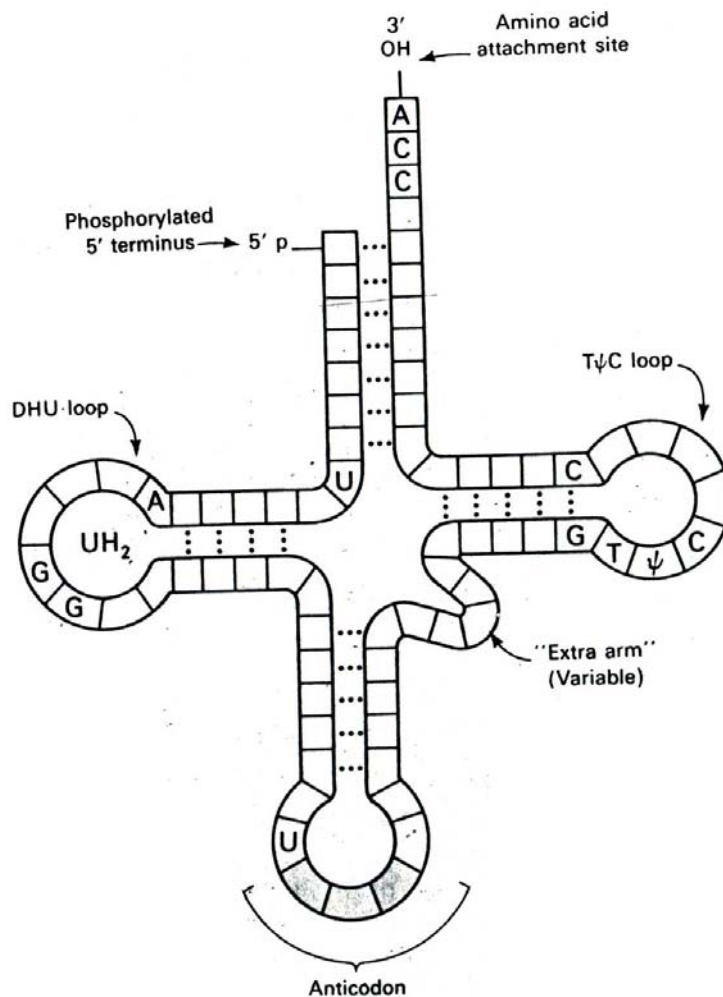

Fig 8.9 Transfer RNA (tRNA)

Ribosomal RNA (rRNA)

rRNA is highly methylated as compared to the other RNAs. rRNA participates in the structure of ribosome. rRNA, ribosomal proteins and Mg^{++} constitute ribosome. The ribosome is made of two subunits big and small.

Ribosomes are ribonucleotide-protein particles, serve as work benches for protein synthesis. About 2/3 of the mass is RNA and rest is protein. In prokaryotes, they float freely in cytoplasm or attach to plasma membrane. Each ribosome consists of a large subunit and a small subunit. They are held together by non-covalent interactions.

Ribosomes are not only found in cytosol but also in mitochondria.

According to their sedimentation rates, the subunits are referred as 30S, & 50S, together they form 70S unit. 30S has 21 proteins and 16S r-RNA. 50S has 31 proteins and 23S, 5S r-RNA.

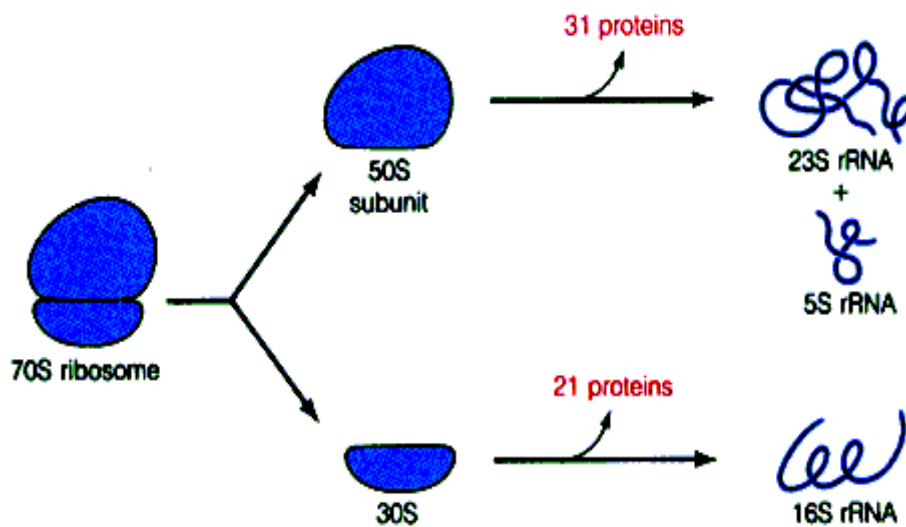

Fig 8.10 components of 70s prokaryotic ribosome

rRNAs are identified

1. In prokaryotic cells as 23s, 16s, and 5s
2. In eukaryotic cells as 28s, 18s, 7s and 5s.

S is for Svedberg unit.

Catabolism of Nucleic acids

Pancreatic enzymes called nucleases hydrolyze both DNA and RNA to nucleotides in the intestinal tract. Nucleic acid is also hydrolyzed by lysosomal enzymes inside tissues. Here in the intestine, the nucleotide is also hydrolyzed to nucleoside and phosphoric acid. The nucleoside is absorbed into blood and transported to peripheral tissues. Excess nitrogen bases are further degraded. Finally adenine and guanine are converted to uric acid in our body which is excreted through urine. Since uric acid has a precipitation character, excess uric acid in kidney causes kidney stone and in joints causes gout.

The degradation of pyrimidine bases are converted to:

1. Cytosine and uracil to ammonia, carbon dioxide and beta-alanine
2. Thymine to NH_3 , CO_2 , H_2O and α -methyl β alanine.

DNA REPLICATION

Synthesis of DNA is called replication. DNA replication starts at the early stage of cell division. It is the way in which the genetic information can pass from parental cell to daughter cell. As stated before, the double helical structure of DNA depends on the base complementarity. Also this complementarity represents the fundamental basis for the formation of new DNA strands from the parent DNA strand in a semi conservative manner. In this process, two daughter DNA's are produced, each has one parent strand (conserved) and newly synthesized strand.

Steps of Replication

Origin of DNA - Replication starts at particular DNA sequence called origin. Origin is rich in T-A-T sequence. In prokaryotic cells origin is at one site. In eukaryotic cells origin is at many sites.

To start DNA replication origin is recognized by special protein called DNA a. Gyrase is a protein which recognizes DNA - origin with the help of DNA b protein. The main function of gyrase is to put the negative super twist on double helix of DNA. But the two strands of DNA can be separated by special protein Helicase. Helicase melts the hydrogen bond of the two strands of DNA. To prevent the recoiling back to the double helix single strand binding protein (SSB) plays the role. SSB binds to the single stranded DNA and thus protects the single strand from rejoining.

Primer synthesis: After the two strands of DNA are separated at origin, short complementary RNA to the single strand parental DNA is synthesized. This RNA is called a primer. In prokaryotic cell the primer length is about 10 - ribonucleotides, but in Eukaryotic cell it is about 30. This primer is synthesized by the enzyme called primase. The primer grows in the 5' → 3' direction which is anti-parallel to the parental DNA. Primer is needed to provide 3'- OH group for building of new DNA by DNA polymerase.

Nascent DNA Synthesis:-

After the primer is synthesized the primase become inactive. There is step by step addition of Deoxyribonucleotide at 3' – OH end of the primer continues. The enzyme is called DNA polymerase. For this reaction the 4 - Deoxyribonucleotides must be available in active form. That is dATP, dGTP, dCTP and dTTP Mg^{2+} is also strictly required. The new DNA is called nascent DNA. It is complementary to the parental DNA called Template. The base sequences of template determines the base sequences of nascent DNA. Nascent DNA grows in the 5'→ 3' direction which is anti-parallel to the template strand. The nascent synthesis of DNA takes place at both strands of the template or parental DNA.

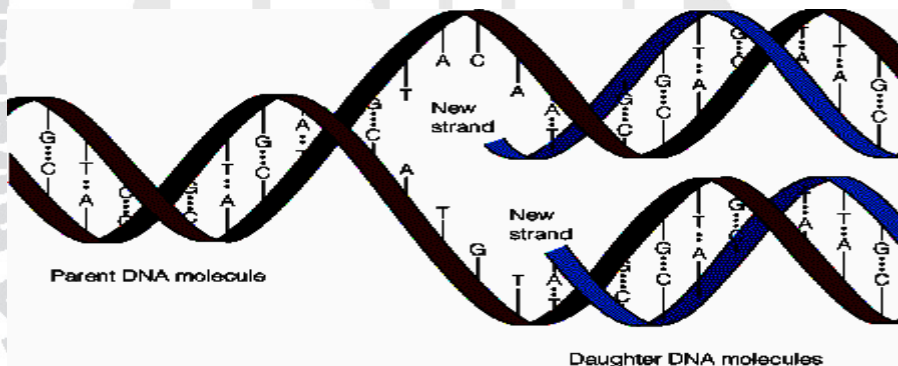

Fig. 8.11 A model for DNA replication

Excision of Primer: In prokaryotic cell the primer is excised by exonuclease activity of DNA polymerase. After the primer is excised, the gap is filled.

Nick Sealing: When ever there is nick in DNA that is lack of phosphodiester linkage, there occurs a phosphodiester linkage formation by special enzyme called DNA Ligase. Ligase seals the nick at the expense of one ATP.

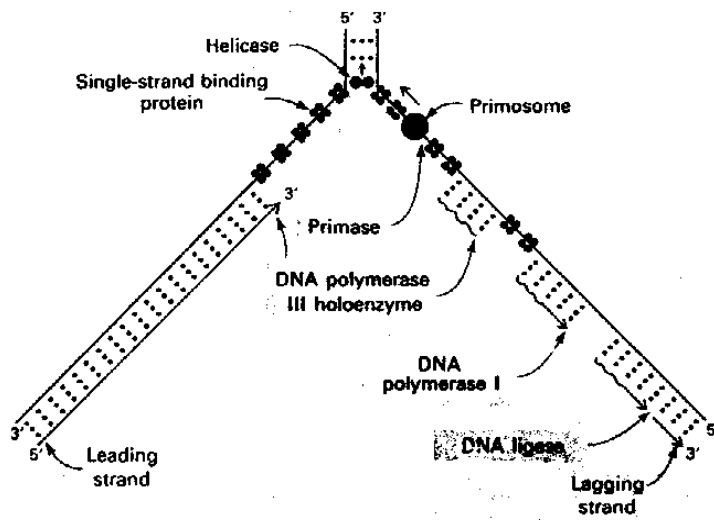

Fig 8.12 Replication fork of DNA

DNA repair

DNA is the only macromolecule that can be repaired, which is important in biological systems. Unless there is a DNA repair there may occur a mutation in DNA.

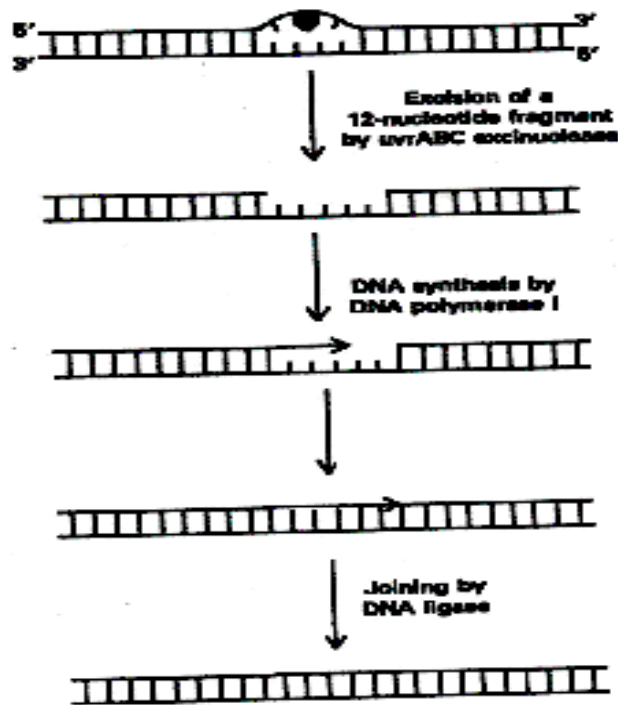

Fig 8.13 DNA repair mechanism

Certain lesions cause distortions in the helical structure of DNA. It is repaired by ABC excinuclease. It has 3 subunits, coded by Urv A, Urv B, Urv C genes. The type of lesions the system repairs include adducts 6.4-photoproducts and pyrimidines dimers.

The enzyme binds to lesion, makes two nicks on the damaged strand, cleaves at 7th and fourth phosphodiester bond. The segment is excised and gap is filled by DNA poly-1 and DNA ligase. Thymine dimers are also repaired the same way.

Urv A protein recognizes lesion, unwinds DNA, causes conformational changes in Urv B. When Urv B binds to the site of lesion, nicks on the 3' side of the lesion. Urv A leaves the site. Now Urv C binds, which makes another nick on 5' side. Then oligonucleotide chain is removed and the gap is filled.

Xeroderma pigmentosum

It is an autosomal recessive condition. It is caused by failure of DNA repair. The pyrimidine dimers due to exposure to UV rays, are not removed. Patient lacks the UV-endonuclease. Symptoms include high sensitivities to UV rays. There are blisters on the skin, hyperpigmentation and finally atrophy of the affected skin. Patient dies of complications like squamous cell carcinoma, skin tumors. Protective ointments like sun blockers from UV rays are beneficial.

RNA Synthesis

Transcription is the process of RNA Synthesis directed by a DNA template. It occurs in three phases:-

1. Initiation
2. Elongation
3. Termination

1. Initiation

Initiation includes promoter. Promoter is a specific sequence in DNA template which is responsible for directing RNA polymerase to initiate transcription at particular point. The left side of that particular point is called upstream. The promoter is found at this upstream. The promoter exceeds about 200 base pairs.

Here is found TATA box which is close to the initiation or starting point. It is within -10 base pairs. About -35 base pairs away is found the consensus base sequences. In between the consensus and TATA box the base sequences are highly variable and it is this sequence that

Post - transcriptional process

Nascent RNA undergoes chemical modifications before it participates in translation. They are called post-transcriptional modifications. In prokaryotes, m RNA requires little modification but t-RNA, r-RNA are synthesized as large precursors, do require modifications.

The post-transcriptional changes of rRNA is base modification mainly methylation and the cleavage of larger precursor by some ribonucleases.

The post-transcriptional changes of tRNA includes the cleavage of larger precursor by endonucleases, addition of CCA sequence of 3' - end of the cleaved tRNA, base modification, i.e. addition of H-atoms in DHU (dihydrouracil) arm, methylation and formation of pseudouridylic acid in the T ψ C arm.

The post - transcriptional changes of mRNA includes addition of cap at 5'-end of the chain. This occurs by addition of 7 - methyl Guanine to the 5' end and may be associated by further methylation of the adjacent sugar moiety of the next nucleotides. This capping is important for the proper translation and stability. The post-transcriptional process of mRNA at 3' end is polyadenylation or formation of poly A tails. It is template independent process that occurs after capping but before splicing. It is catalyzed by poly A polymerase enzyme. The change also includes the splicing process. The precursor molecule of mRNA (heterogenous nuclear RNA; hnRNA) is formed of extra sequences.

Some of the sequences are functional called as Exons. The remaining are intervening sequences which are non-functional called Introns.

The removal of interons to form a completely functional mRNA is catalyzed by large ribonucleoprotein complex called spliceosome. It is made of 5 snurps small nuclear RNA (SnRNA) which are important for selecting the perfect alignment. Splicing involves removal of introns and joining of exons, so that mRNA becomes functional.

The above mentioned post transcriptional processing of mRNA is a character of eukaryotes. The prokaryotic mRNA is functional without any further processing.

Translation or protein synthesis

The genetic information which flows from DNA to mRNA will be translated to the universal language called protein. During transcription the base sequence of DNA determines the base sequence of mRNA. Under translation the base sequence of mRNA determines the amino acid sequences in protein.

Translation has 4 – stages:

1. Activation
2. Initiation
3. Elongation
4. Termination

1. Activation stage of translation:

Under this stage amino acid is esterified with its corresponding tRNA

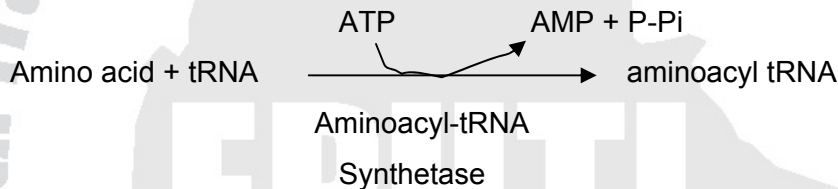

This reaction is a general formula. But we have to know that each of the 20 standard amino acids have their own corresponding tRNA.

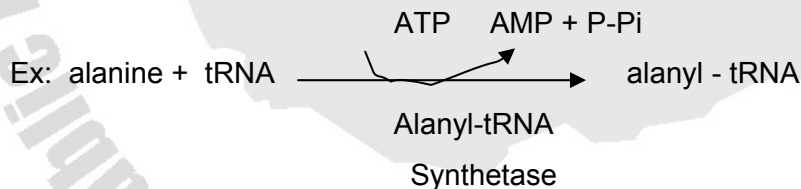

2. Initiation of translation

In prokaryotic cells the 70s ribosome is dissociated into 50s and 30s subunits by IF₃ (Initiation Factor 3), and the IF₃ remains attached to 30s subunit. The 30s subunit with IF₃ binds to the shinedalgarno (AGGAGG) sequence of the 5' - end chain of prokaryotic mRNA. Then moves forwards to the 3' - end until it reaches the initiation codon AUG. In prokaryotic cell initiation codon accept only formyl methionine. Another complex of molecules IF₂, IF₁, GTP, Formyl - methionyl - tRNA binds to AUG and the 30S subunit of ribosome. At this moment the IF₃ will be dissociated from the complex. The bases of anticodon of the tRNA pair with the codon AUG of the mRNA.

After that the 50S subunit of ribosome binds to the whole complex molecules, At this time GTP will be hydrolyzed to GDP + Pi to provide energy. IF₂ and IF₁ will be dissociated from the complex. N - formyl methionyl - tRNA remains in the P- site of the ribosome. This completes the initiation complex. The ribosome has 2 - sites A-site and P-site. (A-site is amino acid site and p-site is peptidyl site). The A-site of ribosome is empty, which is ready to accept aminoacyl tRNA.

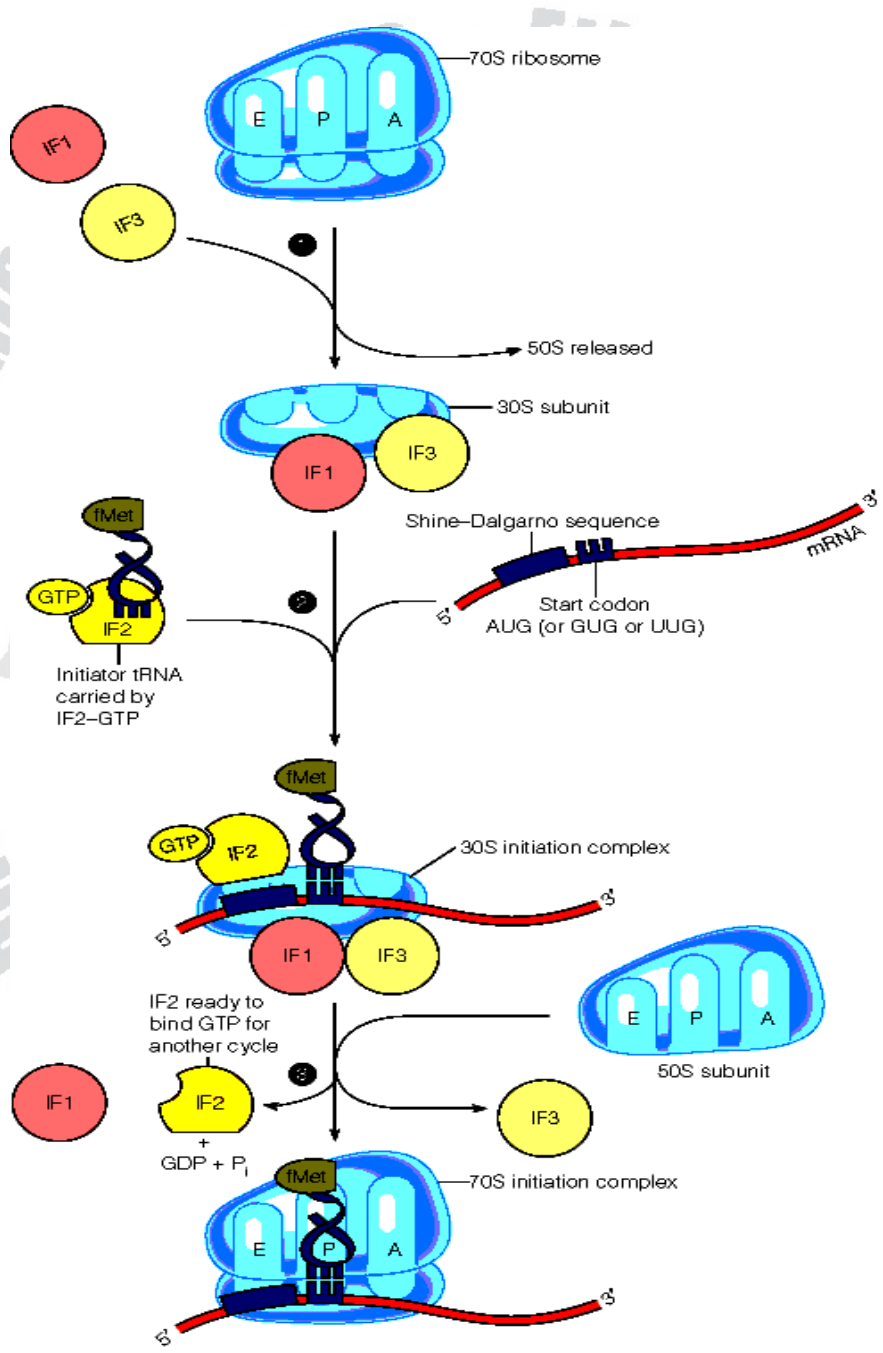

Fig 8.16. Initiation of Translation

3. Elongation of protein chain

Under this stage the activated aminoacyl - tRNA enters the A - site with the help of elongation factor (EF-TU) at the expense of one GTP. The process requires 70S initiation complex, aminoacyl t RNA, complimentary to the next codon (A site) on m RNA.

Three soluble proteins or elongation factors, EF-Tu, EF-Ts, EF-G.

Elongation cycle takes place in 3 steps:

- a. Aminoacyl t RNA is delivered to A site, by EF-Tu, a molecule of GTP is hydrolyzed. EF-Tu ensures, correct codon –anticodon base pairing. GDP remains attached to EF-Tu. Now EF-Ts binds to EF-Tu-GDP complex. Another GTP binds to EF-Tu and releases GDP. Thus EF-Tu-GTP is ready to start another cycle of elongation.
- b. Formation of peptide bond: Both A and P sites on ribosome are occupied. N-formyl methionine from P site is transferred to amino group of aminoacyl t RNA at A site, to form dipeptidyl t RNA. The reaction is catalyzed by peptidyltransferase, located on 23S rRNA of 50 S subunit. At this stage there is an uncharged t RNA at P site and dipeptidyl t RNA at A site.
- c. Translocation: Ribosome moves along m RNA by three bases. Codon-anticodon pairing remains uninterrupted during translocation. The step requires GTP binding, elongation factor (EF-G). Dipeptidyl t RNA is present at A site, t RNA from P site is released. Since ribosome has moved by 3 bases, A site is relocated at P site. A newly created A site is waiting for the next aminoacyl t RNA. This way elongation cycle is repeated until termination codon reaches to A site.

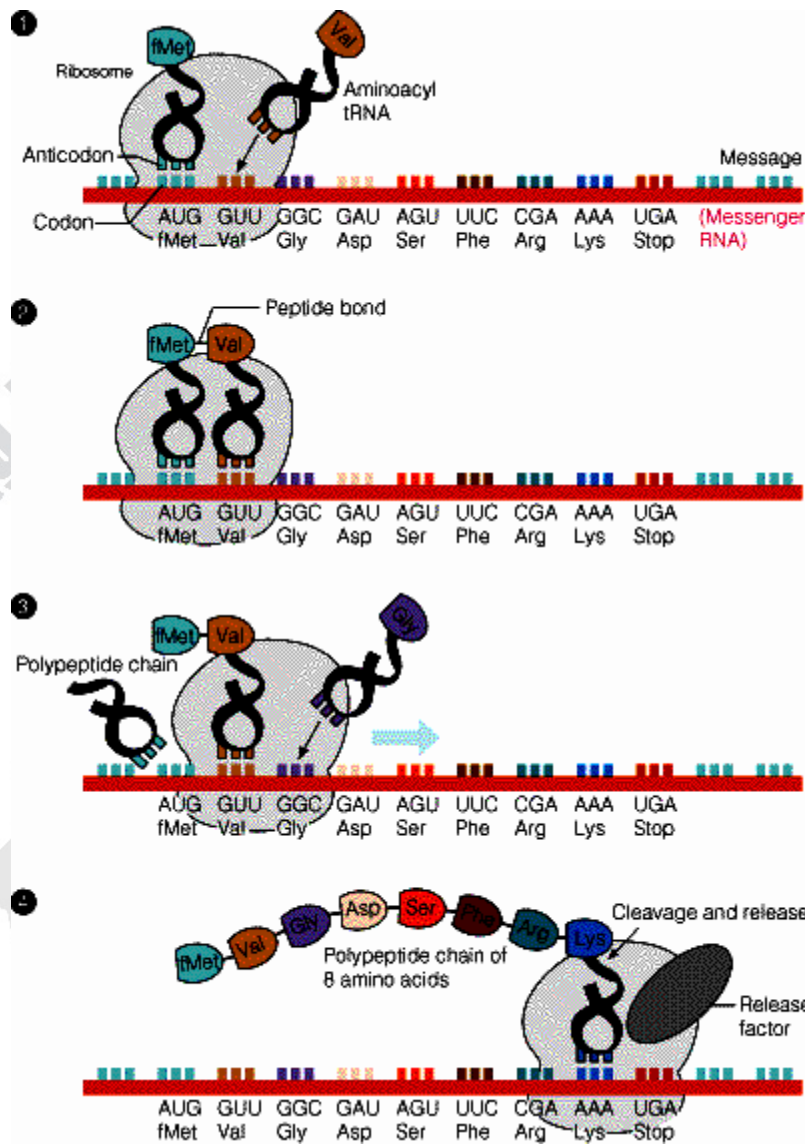

Fig 8.17. Elongation of protein chain

4. Termination stage

The movement of the ribosome consequently reaches to the termination site of mRNA. The termination site contains UAG, or UAA, or UGA. These codons are called stop codons. No tRNA has anticodons that pairs with the stop codons. In addition to that the release factors (RF) bind to stop codons and hydrolyzes the aminoacyl esters liberating the peptide chain or protein, the mRNA and the ribosome. (It is illustrated in the following Figure8.18).

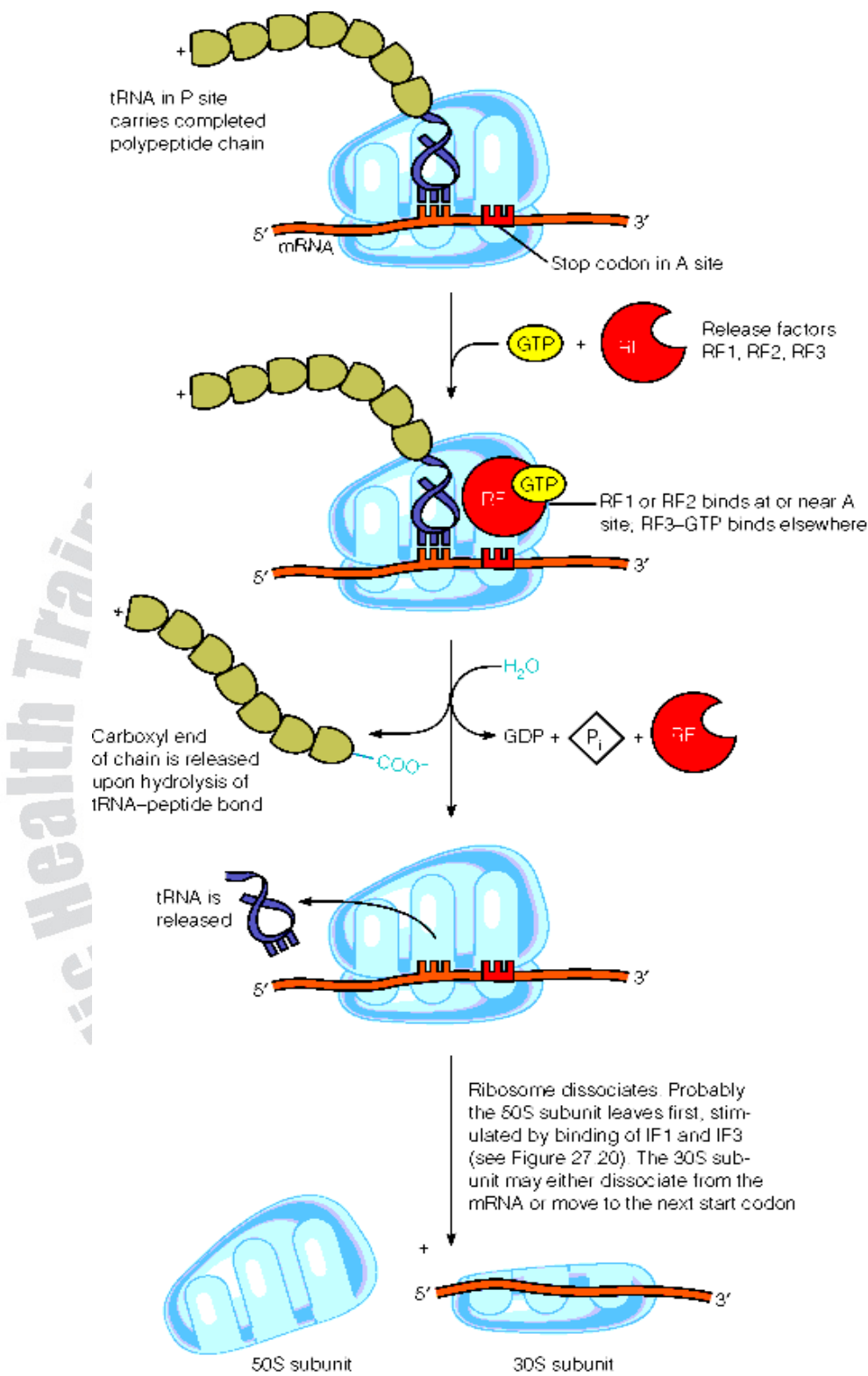

Fig:8.18 Termination of protein synthesis

Inhibitors of Protein synthesis

Streptomycin binds to 30 S ribosomal subunit, inhibits the formation of initiation complex.

Tetracycline binds to 30 S, inhibits the binding of aminoacyl t RNA to the A site.

Chloroamphenicol binds to 50 S subunit and inhibit peptidyl transferase. Similarly erythromycin inhibits translocation

Diphtheria toxin: Coryn bacterium diphtheria produce lethal protein toxin .It binds to EF-2 in eukaryotes, prevents translocation.

Puromycin has structural resemblance to tyrosinyl aminoacyl t RNA .It forms peptide bond and terminates protein chain.

Most antibiotics that act on ribosomes are not bactericidal..

Regulation of protein synthesis

In bacteria the regulatory gene I is expressed to produce catabolites activator protein (CAP).

CAP with cAMP binds to the promotor of glycolytic enzymes gene. This binding facilitates the transcription of structural gene RNA polymerase. The expression of the structural gene produces the glycolytic enzymes. This enzymes carry out the glycolytic reaction in bacteria, but at times of excess energy and if glycolysis is not required one of the glycolytic intermediate molecules inactivate Adenylate cyclase and activates phosphodiesterase by this cAMP in which it gets diminished. CAP without cAMP is inactive, therefore no expression on structural gene.

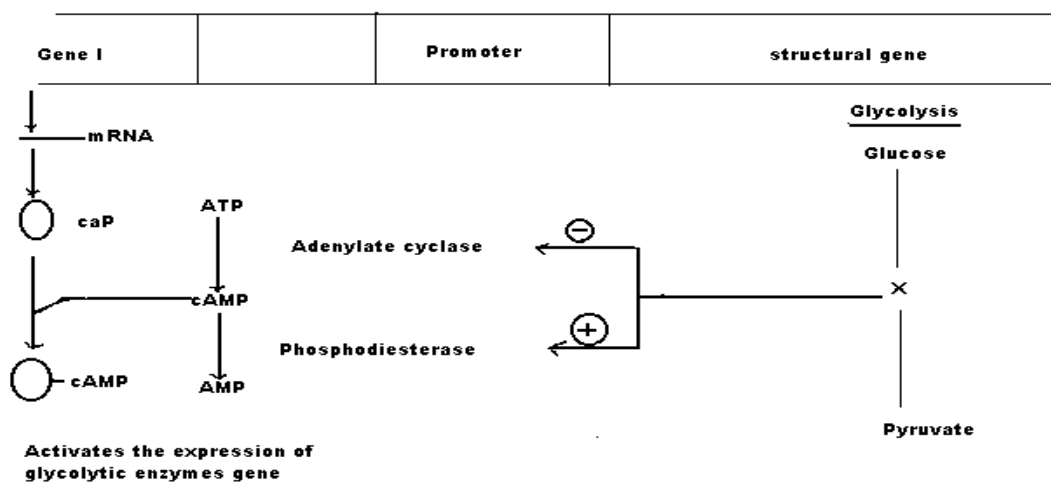

Fig 8.19 regulation of protein synthesis

The Genetic Code

Genetic information is coded in form of base sequences. A sequence of 3 bases in m-RNA codes for a single amino acid. Code is a triplet.

- A. Genetic code is degenerate /redundant. A given amino acid may be coded by more than one codon. Eg. Isoleucine coded by AUU, AUC, AUA. For 20 amino acids there are 61 codons.
- B. Genetic code is universal. A specific codon codes for the same amino acid in any species. Exception is AUG which codes for methionine in eukaryotes, and N-formyl methionine in prokaryotes. In case of mitochondrial DNA, UGA codes for tryptophane, rather than act as stop codon.
- C. It is non-overlapping. Successive codons occur one after other. They do not share any common nucleotide.
- D. It is comma less. There is no punctuation in genetic code and there are no empty spaces in between two codons.
- E. It is collinear. The sequence of amino acids in the polypeptide chain, from the amino terminus to carboxyl end corresponds to the base sequence of a gene (from 5' to 3' end).
- F. There are three stop codons, UAA, UAG, UGA to stop protein synthesis. They do not code for any amino acids, they act as releasing factors.
- G. AUG is the initiation codon.

B a s e 2

Base 1	U	C	A	G	Base 3
U	Phe Phe Leu leu	Ser Ser Ser ser	Tyr Tyr Stop stop	Cyst Cyst Stop trp	U C A G
C	Leu Leu Leu Leu	Pro Pro Pro Pro	His His Gln Gln	Arg Arg Arg Arg	U C A G
A	Ile Ile Ile Met	Thr Thr Thr Thr	Asn Asn Lys lys	Ser Ser Arg Arg	U C A G
G	Val Val Val Val	Ala Ala Ala Ala	Asp Asp Glu Glu	Gly Gly Gly Gly	U C A G

Table 8.1 The genetic code

Post translational processes

After protein is synthesized it must be modified so that it fits its biological role.

Some of the modifications are:

- The reaction of peptidyl deformylase removes the N-formyl methionyl or methionyl part from the NH₂-end of a protein chain
- Disulphide bond formation to fold the protein
- Formation of prosthetic group, so that the protein carries out its biological function.

SUMMARY

The genetic information is stored in DNA. At the early stage of cell division DNA is replicated, means it forms its copy or replica. Because each daughter cells must carry the all genetic information what their parents contain.

When DNA is replicated we see the flow of genetic information from DNA to DNA. When RNA is synthesized we see the flow of genetic information from DNA to RNA. When protein is synthesized we see the translation of genetic information into the universal language called protein.

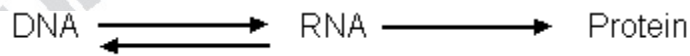

This is the central dogma.

The base sequence of parental DNA determines the base sequences of new born daughter DNA, during DNA replication. The base sequences of DNA determines the base sequences of RNA by means of transcription. The base sequences or the codon sequence of mRNA determines the amino acid sequences in protein during translation. The tRNA reads what is written in mRNA and translates it into the universal language called protein.

GLOSSARY

α -helix A coiled secondary structure of a polypeptide chain formed by hydrogen bonding between amino acids separated by four residues

Actin An abundant 43-Kd protein that polymerizes to form cytoskeleton filaments

Activation energy The energy required to raise a molecule to its transition state to undergo a chemical reaction.

Active site The region of an enzyme that binds substrates and catalyzes an enzymatic reaction.

Active transport The transport of molecules in an energetically unfavorable direction across a membrane coupled to the hydrolysis of ATP or other source of energy.

Adenine A purine that base pairs with either thymine or uracil.

Adenoma A benign tumor arising from glandular epithelium.

Adenyl cyclase An enzyme that catalyzes the formation of cyclic AMP from ATP.

Allosteric regulation The regulation of enzymes by small molecules that bind to a site distinct from the active site, changing the conformation and catalytic activity of the enzyme.

Alternative splicing The generation of different mRNAs by varying the pattern of pre-mRNA splicing,

Amino acid Monomeric building blocks of proteins, consisting of a carbon atom bound to a carboxyl group, an amino group, a hydrogen atom and a distinctive side chain.

Amino acyl-tRNA synthetase An enzyme that joins a specific amino acid to a tRNA molecule carrying the correct anticodon sequence.

Amphipathic A molecule that has both hydrophobic and hydrophilic regions

Antibody A protein produced by B-lymphocytes that binds to a foreign molecules

Antigen A molecule against which the antibody is directed.

ATP (adenosine 5'-triphosphate) an adenine-containing nucleoside triphosphate that serves as a currency of free energy in the cell.

ATP Synthase A membrane spanning protein complex that couples the energetically favourable transport of protons across a membrane to the synthesis of ATP.

β -sheet A sheet like secondary structure of a polypeptide chain ,formed by hydrogen bonding between amino acids located in different regions of the polypeptide

Base excision repair A mechanism of DNA repair in which single damaged bases are removed from a DNA molecule.

Benign tumor A tumor that remains confined to its site of origin.

cAMP phosphodiesterase An enzyme that degrades cyclic AMP.

cAMP-dependent protein kinase see protein kinase A

Carbohydrate A molecule with the formula $(\text{CH}_2\text{O})_n$. Carbohydrates include both simple sugars and polysaccharides.

Carcinogen A cancer-inducing agent

Carcinoma A cancer of epithelial cells

Cardiolipin A phospholipids containing four hydrocarbon chains

Carrier proteins proteins that selectively bind and transport small molecules across a membrane

Catalase An enzyme that decomposes hydrogen peroxide

Cellulose The principal structural component of the plant cell wall ,a linear polymer of glucose residues linked by β -(1,4)glycosidic bonds

Cellulase An enzyme which degrades cellulose

cGMP phosphodiesterase An enzyme that degrades cGMP.

Chemiosmotic coupling The generation of ATP from energy stored in a proton gradient across a membrane.

Chitin a polymer of N-acetylglucosamine residue that is the principal component of fungal cell walls and exoskeleton of insects.

Cholesterol A sterol consisting of four hydrocarbon rings .cholesterol is a major constituent of animal cell plasma membranes and the precursor of steroid hormones

Chromosomes The carrier of genes, consisting of long DNA molecules and associated proteins.

Codon The basic unit of genetic code; one of the 64 nucleotide triplets that code for an amino acid or stop sequence.

CoenzymeA (CoA) A coenzyme that function as a carrier of acyl groups in metabolic reactions.

Coenzyme Q. A small lipid –soluble molecule that carries electrons between protein complexes in the mitochondrial electron transport chain.

Coenzymes. Low molecular-weight organic molecules that work together with enzymes to catalyze biological reactions

Collagen The major structural protein of the extracellular matrix.

Corticosteroids are steroids produced by the adrenal gland.

Cyclic AMP (cAMP) Adenosine monophosphate in which the phosphate group is covalently bound to both the 3' and 5' carbon atoms, forming a cyclic structure; an important second messenger in the response of cells to a variety of hormones.

Cytochrome oxidase A protein complex in the electron transport chain that accepts electrons from cytochrome c and transfer them to O₂.

Deoxyribonucleic acid (DNA) The genetic material of the cell.

Diacyl glycerol (DAG) A secondary messenger formed from the hydrolysis of PIP₂ that activates protein kinaseC

DNA glycosylase A DNA repair enzyme that cleaves the bond between purine or pyrimidine linked to deoxyribose of DNA

DNA ligase An enzyme that seals the breaks in the DNA strands

DNA polymerase An enzyme catalyzes the synthesis of DNA from deoxy ribonucleotides

Eicosanoids A class of lipids including prostglandins, prostacyclins, thromboxanes and leukotrienes that act in autocrine and paracrine signaling

Electron transport chain A series of carriers through which electrons are transported from a higher to lower energy state.

Endocytosis The uptake of extra cellular material in vesicles formed from the plasma membrane

Endoplasmic reticulum (ER) An excessive network of membrane-enclosed tubules and sacs involved in protein sorting and processing as well as in lipid synthesis

Enhancer transcriptional regulatory sequence that can be located at a site distant from the promoter

Enzymes Proteins or RNAs that catalyze biological reactions

Epidermal cells Cells forming a protective layer on the surface of plants and animals

Epithelial cells Cells forming sheets that cover the surface of the body and line internal organs

Exon A segment of a gene that contains a coding sequence

Exonuclease An enzyme that hydrolyzes DNA molecule at either 5' or 3' direction

Fats See triacyl glycerol

Fatty acids Long hydrocarbon chains usually linked to a carboxylic group

Feed back inhibition A type of Allosteric regulation in which the product of a metabolic pathway inhibits the activity of an enzyme involved in its synthesis

Flavin adenine dinucleotide (FAD) A co enzyme that functions as an electron carrier in oxidation/reduction reactions

G-proteins A family of cell signaling proteins regulated by guanine nucleotide binding.

Genetic code The correspondence between nucleotide triplet and amino acids in proteins

Gibbs free energy (G) The thermodynamic function that combines the effects of enthalpy and entropy to predict the energetically favorable direction of a chemical reaction

Gluconeogenesis The synthesis of glucose from non carbohydrate substrates

Glycerophospholipids Phospholipids consisting of one or two fatty acids bound to a glycerol molecule

Glycogen A polymer of glucose residues that is the principal storage form of carbohydrates in animals

Glycolipid A lipid consisting of carbohydrates

Glycolysis The aerobic breakdown of glucose

Glycoprotein A protein linked to oligosaccharides

Glycosaminoglycans (GAG) A gel forming polysaccharide of the extra cellular matrix

Glycosidic bond A bond formed between sugar residues

Glycosylation The addition of carbohydrate to proteins

Golgi apparatus A cytoplasmic organelle involved in the processing and sorting of proteins and lipids

Guanine a purine that base pairs cytosine

Heat shock proteins A highly conserved group of chaperone proteins expressed in cells exposed to stress.

Helicase an enzyme that catalyzes the unwinding of DNA

High energy bonds Chemical bond that release a large amount of free energy when they are hydrolyzed

Hormones Signaling molecules produced by endocrine glands and tissues

Hydrophilic soluble in water

Hydrophobic not soluble in water

Inositol 1, 4, 5 –tri phosphate (IP₃) A second messenger that signals the release of calcium ions from the endoplasmic reticulum.

Integral membrane proteins proteins embedded within the lipid bilayer of cell membranes

Intracellular signal transduction A chain of reactions that permits chemical signals from the cell surface to their intracellular targets

Intron The non-coding sequence that interrupts exons in a gene

Ion pump A protein that couples ATP hydrolysis to the transport of ions across a membrane

Keratin a type of intermediate protein of epithelial cells

Krebs cycle; see citric acid cycle

Lagging strand The strand of DNA synthesized opposite to the direction of movement of the replication fork by formation of Okazaki fragments

Leading strand The strand of DNA synthesized continuously in the direction of movement of the replication fork

Lipids Hydrophobic molecules, soluble in organic solvents, that function as energy storage molecules, signaling molecules and the major components of cell membranes

Lysosome A cytoplasmic organelle containing enzymes that break down biological polymers

5' methyl guanosine cap A structure consisting of GTP and methylated sugars that is added to the 5' end of eukaryotic mRNA

Mitochondria Cytoplasmic organelle responsible for synthesis of ATP in eukaryotic cells by oxidative Phosphorylation

Monosaccharides simple sugars that cannot be further hydrolyzed

Mutation A genetic alteration

Na⁺ - K⁺ pump An ion pump that transport Na⁺ out of the cell and K⁺ in to the cell.

Nicotinamide-Adenine dinucleotide (NAD⁺) a coenzyme that functions as an electron carrier in oxidation/reduction reactions

Nucleoside A purine or pyrimidine base linked to a sugar(Ribose or deoxy ribose)

Nucleotide A phosphorylated nucleoside

Nucleus The most prominent organelle of eukaryotic cells, contains the genetic material

Oligosaccharide A short polymer of only a few sugars

Oxidative Phosphorylation The synthesis of ATP from ADP coupled to the energetically favorable transfer of electrons to molecular oxygen as the final acceptor in an electron transport chain.

Peptide bond The bond joining amino acids in a polypeptide

Phagocytosis The uptake of large particles such as bacteria by a cell.

Phospholipids The principal components of cell membranes, consisting of two hydrocarbon chains (fatty acids) joined to glycerol and phosphate

Phosphorylation The addition of phosphate group to a molecule

Pinocytosis The uptake of fluids and molecules into a cell by small vesicles

Plasma membrane A phospholipids bi-layer with proteins that surrounds the cell

Polypeptide A polymer of amino acids

Primary structure The sequence of amino acids in a polypeptide chain

Prokaryotic cells Cells lacking a nuclear envelope, ctoplasmic organelle, and a cytoskeleton for example bacteria

Prosthetic groups Small molecules bound to proteins

Protein kinase An enzyme that phosphorylates proteins by transferring a phosphate group from ATP.

Protein phosphatase An enzyme that reverses the action of protein kinases by removing phosphate groups.

Proteins Polypeptides with a unique amino acid sequence

Proteoglycan A protein linked to glycosaminoglycans

Proteolysis Degradation of polypeptide chains

Quaternary structure The interaction between polypeptide chains in proteins consisting of more than one polypeptide

Receptor mediated endocytosis The selective uptake of macromolecules that bind to cell surface receptors.

Replication fork The region of DNA synthesis where the parental strands separates and two new daughter strands elongate

Rhodopsin A G protein- coupled photoreceptor in retinal rod cells that activate transducin in response to light absorption

Ribonucleic acid A polymer of ribonucleotides

rRNA The RNA component of Ribosomes

Ribosomes Particles composed of RNA and protein that are required for protein synthesis

Second messenger A compound whose metabolism is modified as a result of a hormone - receptor interaction, It functions as a signal transducer by regulating intra cellular processes

Secondary structure The regular arrangement of amino acids within localized regions of a polypeptide chain. See α helix and β -sheets

Sphingomyelin A phospholipids consisting of sphingosine, fatty acid bound to a polar head group

Starch A polymer of glucose residues, principal storage form of carbohydrates in plants

Steroid hormones A group of hydrophobic hormones that are derived from cholesterol

Substrate A molecule acted up on by an enzyme

Tertiary structure The three dimensional folding of a polypeptide chain that gives the protein its functional form

Thymine A pyrimidine found in DNA that pairs with adenine

Thyroxine A hormone synthesized from tyrosine in the thyroid gland

Transfer RNA (tRNA) Molecule that functions as adaptor between amino acids and mRNA during protein synthesis

Translation The synthesis of polypeptide chain from mRNA

Triacyl glycerol Three fatty acids linked to a glycerol molecule by ester linkage

Uracil A pyrimidine found in RNA that base pairs with adenine

REFERENCES

1. **Stryer L.** 1995. Biochemistry. 4th ed. W.H. Freeman and company.
2. **Robert K., Murray R. K., Granner D. K., Mayes P. A., Rodwell, V. W.** 1993. Harpers Biochemistry. 23rd ed. Prentice-Hall International Inc.
3. **Lehninger A. L.** 1975. Biochemistry. 2nd ed. Worth publishers Inc.
4. **Colby D. S.** 1985. Biochemistry: A synopsis. Middle east edition
5. **Schlegel H. G.** 1986. General microbiology. 6th ed. Cambridge University Press.
6. **Champe P. C. Harvey R. A.** 1994. Lippincott's Illustrated Review: Biochemistry. 2nd ed. J. B. Lippincott company.
7. **Apps D. K., Cohn B. B. and Steel C. M.** 1992. Biochemistry. A concise text for medical students. 5th ed. ELBS with Baillie're Tindall.
8. **Baynes.Dominiczak,** Medical Biochemistry: 1999.
9. **Thomas M.Devlin,** Textbook of Biochemistry, fourth edition: 1997.
10. **Wood.Wilson:** Biochemistry a problem based approach, third edition: 1998.
11. **Nath R.K,** A textbook of Medical Biochemistry: 1996.
12. **David L.Nelson, Michael M.Cox,** Priciple of Biochemistry, third edition: 2000.
13. **Guyton and Hall,** Textbook of Medical Physiology, ninth edition: 1996.