

MODULE

# *Common Skin Diseases*

Diploma Program  
For the Ethiopian Health Center Team



**Ethiopia Public Health  
Training Initiative**

Zewdu Bezie, Bishaw Deboch, Dereje Ayele, Desta Workeneh, Muluneh Haile,  
Gebru Mulugeta, Getachew Belay, Adane Sewhunegn, Ahmed Mohammed

Jimma University

In collaboration with the Ethiopia Public Health Training Initiative, The Carter Center,  
the Ethiopia Ministry of Health, and the Ethiopia Ministry of Education

2005



Funded under USAID Cooperative Agreement No. 663-A-00-00-0358-00.

Produced in collaboration with the Ethiopia Public Health Training Initiative, The Carter Center, the Ethiopia Ministry of Health, and the Ethiopia Ministry of Education.

### **Important Guidelines for Printing and Photocopying**

Limited permission is granted free of charge to print or photocopy all pages of this publication for educational, not-for-profit use by health care workers, students or faculty. All copies must retain all author credits and copyright notices included in the original document. Under no circumstances is it permissible to sell or distribute on a commercial basis, or to claim authorship of, copies of material reproduced from this publication.

**©2005 by Zewdu Bezie, Bishaw Deboch, Dereje Ayele, Desta Workeneh, Muluneh Haile, Gebru Mulugeta, Getachew Belay, Adane Sewhunegn, Ahmed Mohammed**

All rights reserved. Except as expressly provided above, no part of this publication may be reproduced or transmitted in any form or by any means, electronic or mechanical, including photocopying, recording, or by any information storage and retrieval system, without written permission of the author or authors.

*This material is intended for educational use only by practicing health care workers or students and faculty in a health care field.*

## ACKNOWLEDGEMENT

The preparation of this module has passed through series of meetings, discussions revisions and group works.

We, the authors would like to express our deep appreciation to The Carter Centre, Atlanta, Georgia for funding the activities all the way through.

And we extend our heart felt thanks to our reviewer Dr.Kifle W / Micheal who has contributed for the success of this work.

We would also like to extend our gratitude to w/t Tsegereda Fiseha for typing the manuscript.

## PREFACE

Teaching –learning is a challenge under all circumstances. It is even more challenging in developing countries like Ethiopia where textbooks are scarce, learning materials few, teachers overwhelmed and conditions unfavorable. Moreover, many of the learning materials such as textbooks are often bulky and at times not suitable to the conditions existing in the home country.

This module is prepared specifically for the health centre team, which must learn to work effectively together. The health centre team is basically involved in primary care at the grass-root level. Most of the activities concentrate on health promotion, identification and treatment of common illnesses, and disease prevention and control.

This module addresses common skin diseases, which are a major public health problem in Ethiopia. It consists of a core module and five satellite modules. The Core Module is prepared for health officers, public health nurses, environmental health, medical laboratory technology students and Health extension Workers. We believe that the essentials of common skin infections should be known by all categories. Therefore the satellite modules are prepared to strengthen the professional training of each category. On top of that they supplement what is included in the Core module.

It should be pointed out that this module is not supposed to replace textbooks. This module does show clearly that it is essential to consider the teacher, the students, the learning materials and the circumstances together. It is hoped that the reading of this module will stimulate teachers to produce teaching materials that are problem-based and learner centered.

# TABLE OF CONTENTS

<b>Contents</b>	<b>Page</b>
Acknowledgement .....	i
Preface .....	ii
Table of contents .....	iii
List of figures .....	iv
<b>UNIT ONE</b> .....	<b>1</b>
1.1 Introduction .....	1
1.2 Directions for using the Module .....	2
1.3 Purpose and use of the Module .....	2
<b>UNIT TWO</b>	
Core Module .....	3
<b>UNIT THREE</b>	
Satellite Module for Health Officers .....	10
<b>UNIT FOUR</b>	
Satellite Module for Nurses .....	59
<b>UNIT FIVE</b>	
Satellite Module for Laboratory Personnel .....	105
<b>UNIT SIX</b>	
Satellite Module for Environmental Health .....	121
<b>UNIT SEVEN</b>	
Satellite Module for Health Extension Workers .....	136
<b>UNIT EIGHT</b>	
Annexes .....	164
8.1 Diagnostic guide .....	164
8.2 Answer Keys .....	185
8.3 Bibliography .....	188
8.4 About Authors .....	190

## List of Figures

1. Figure .1 Pathogenesis of Herpes simplex Virus .....	27
2. Figure 2. Normal Pelosebacous unit .....	43
3. Figure 3. Fungal hypae .....	117
4. Figure 4. Candidia Albucans Yeast .....	117
5. Figure 5. Leishmania amstigotes in Giemsa stained Skin snip .....	120

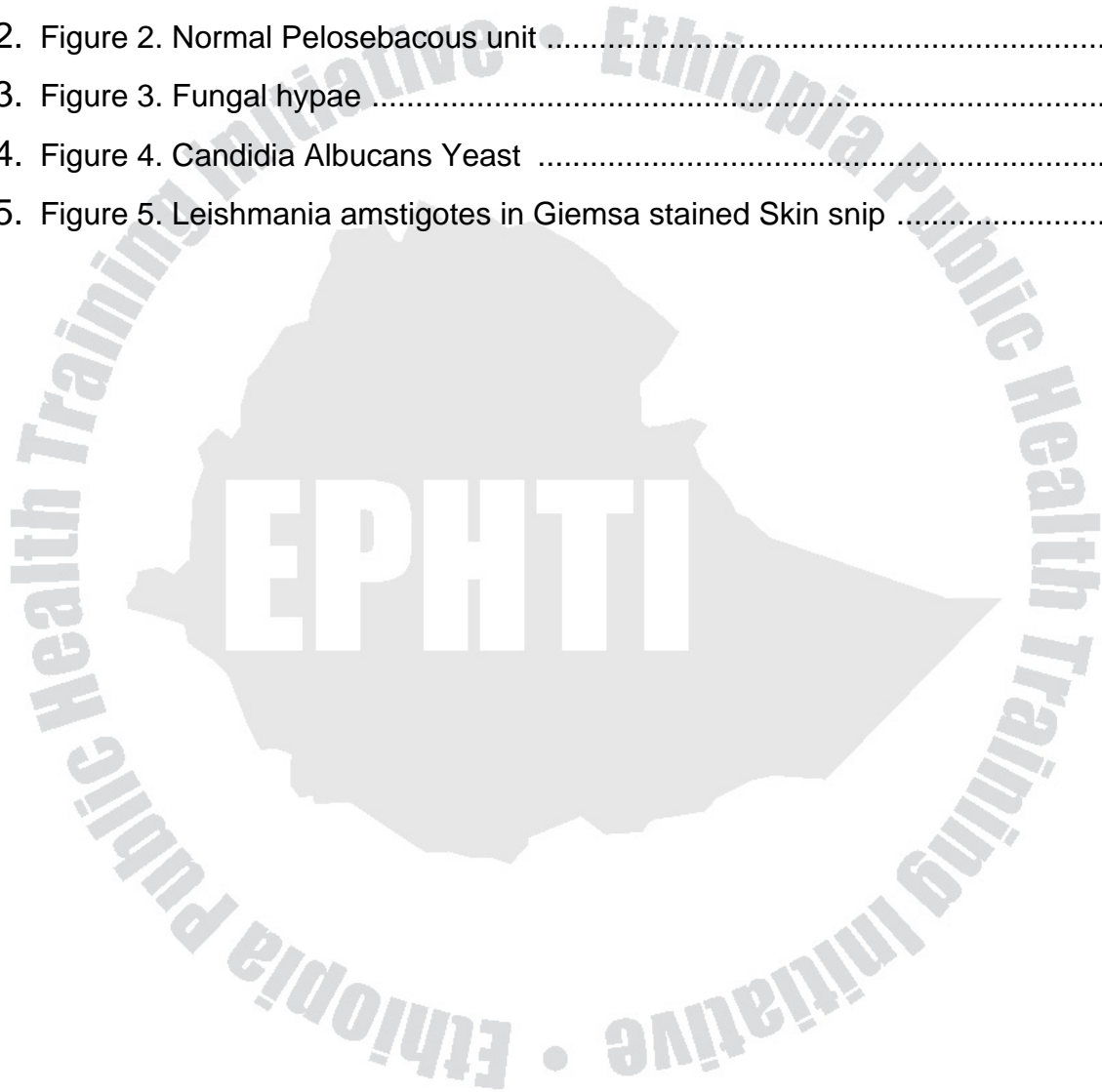

# UNIT ONE

## INTRODUCTION

### 1.1 Introduction

The importance of skin disease is usually overlooked. However; dermatological conditions and sexually transmitted infections (STIs) are highly prevalent in Africa including our country and some of the conditions are on the rise. The HIV/AIDS pandemic, changing life style of the societies, increasing use of industrial chemicals, global warming and more are incriminated as the contributing factors for the rise in the prevalence of some skin diseases. Some 90% of patients with HIV/AIDS will have one or more dermatological manifestations at early stage of the disease. In some centers, 28% of medical and 25% of pediatrics cases have dermatological problems. On the other hand, little changes have been made to tackle the problems.

Although most of the dermatological conditions do not result in death, they lead to misery and incapacitations. The quality of life in this group of patients is compromised in different ways. Apart from the morbidity which is usually chronic, patients face a lot of agony from social stigma and low self esteem due to deformities and disabilities of various degrees. For one or more of the reasons they become unproductive and live in poverty of a deeper degree.

Despite the extent of the problem, dermatology service delivery in our country has remained poor. Some of the reasons are poverty, lack of trained staff and lack of knowledge.

The intent of this module is to highlight the Health Officers, Nurses, Medical Laboratory Technicians and Environmental Health Technicians with the diagnosis, management, control, and prevention of common dermatological conditions in our setting.

## **1.2 Direction for using this Module**

To be well equipped with the necessary knowledge and competent care for a patient with skin infections by using this module; follow these directions first:

- Try to study and answer all the questions in the pre-test that is for all categories in the core module, and the specific questions to your category in the respective satellite module
- After the pretest go through the core module
- Each category of the health center team should read their respective satellite module
- Answer all the questions in the pretest and compare your results using the keys after finishing the core and satellite modules.
- Study and discuss the specific learning objectives, activities and roles of each category of the health center team.

## **1.3 Purpose and use of this Module**

Lack of appropriate and relevant teaching materials are some of the problems that hinder training of effective, competent task oriented professionals who are well versed with the knowledge, attitudes and skills that would enable them to solve the problems of the community. Preparation of such teaching materials is an important milestone in an effort towards achieving these long-term goals.

Therefore, this module is prepared to facilitate the process of equipping trainees with adequate knowledge and skills through interactive teaching mainly focused on the most common skin diseases.

The module can be used in the basic training of health center teams in the training institutions and training of health center teams who are already working in the community, health workers and care givers. However, it is not intended to replace standard textbooks or reference materials.



## UNIT TWO

### CORE MODULE

#### 2.1 Pre test for all category

1. Which one of the following is not a function of the skin?
  - a) *an immunologic organ*
  - b) *protection and thermoregulation*
  - c) *storage of and fats and synthesis vitamin D*
  - d) *sensation, display and identity*
  - e) *none*
2. All of the following are primary skin lesions except
  - a) *papule*
  - b) *Vesicle*
  - c) *macule*
  - d) *pustule*
  - e) *ulcer*
3. Bullous impetigo is most commonly seen in:
  - a) *Adults*
  - b) *Adolescents*
  - c) *Neonates and Infants*
  - d) *Pre school children*
  - e) *Elderly*
4. An acute, deep-seated, red, hot, tender nodule or abscess that evolves from a staphylococcal folliculitis is
  - a) *Ichthyma*
  - b) *Cellulitis*
  - c) *Furuncle*
  - d) *Erysipelas*
  - e) *Necrotizing fasciitis*

5. The factors associated with increased colonization rate of *Candida* include/s
- a) *Usage of broad spectrum antibiotics for long periods*
  - b) *Diabetes mellitus*
  - c) *Depressed cell mediated immunity*
  - d) *Pregnancy*
  - e) *All of the above*
6. One of the following could contribute for the reactivation of herpes simplex infection except:-
- a) *UV rays*
  - b) *Trauma to the skin site*
  - c) *Local / Systemic immuno - suppression*
  - d) *Fever*
  - e) *None of the above.*
7. Which of the following is /are predisposing factors for bacterial skin infection?
- a) *Scabies , superficial fungal infection and molluscum contagiosum*
  - b) *Sunlight exposure*
  - c) *Lymphatic and/ or venous insufficiencies*
  - d) *Traumas to the skin*
  - e) *Eczemas*
8. Chose the wrong statement about T. capitis
- a) *It shares a common age group with acne Vulgaris*
  - b) *Griseofulvin is the treatment of choice*
  - c) *White scaly patches on the scalp with hair loss is the most common mode of presentation*
  - d) *Kerion and favus are rare variants of T. capitis*
  - e) *Topical treatments decreases transition but not enough to treat T.capitis*
9. Which one of the following is not true concerning warts?
- a) *They are caused by human papilloma viruses*
  - b) *Warts are commonly seen in adults*
  - c) *Most warts disappear by themselves*
  - d) *Venereal warts are sexually transmitted*
  - e) *Warts may contribute to carcinogenesis*

10. Regarding atopic eczema which one of the following statements is incorrect?
- a) *It has genetic and environmental contributing factors for its development.*
  - b) *The diagnosis is made using a set of criteria*
  - c) *Mostly it manifests during early childhood.*
  - d) *It is highly related to bronchial asthma, hay fever and allergic rhinitis*
  - e) *Frequent bathing with soaps is advisable as part of its management*

## **2.2 Significance and brief description of common skin diseases**

Skin diseases occur all over the world at significant levels. They have been identified as a public health problem in developing countries. They are common through-out Africa and are dominated by bacterial and superficial fungal infections. The eczemas are ubiquitous. In some areas discoid lupus erythematosus is common and lichen planus is seen far more frequently than in temperate countries. Then there are the more chronic infections: Leprosy, Leishmaniasis, scabies and onchocerciasis– which affect the skin so distinctively; the whole range of ulcers of the skin; and the serious effects on the skin of protein malnutrition.

Skin diseases affect all segments of the population with out ethnic variability but are more prevalent among children and in low socioeconomic groups, essentially due to poor hygienic practices. Different studies also suggest that skin infections are more prevalent in extreme climatic conditions. Most skin infections transmit through contact with infected individuals or articles.

Skin diseases are among the leading causes of hospital visits in Ethiopia. An analysis performed from June1995-July1997 to describe the pattern of skin infection at the dermatologic referral clinic of Black Lion Teaching Hospital (BLH) showed that allergic and infectious causes account for three quarters of skin problems. Another study carried out in 1996 to determine the prevalence of skin diseases among school children in rural Ethiopia, showed that 80.4% of school children assessed were found to have one or more skin diseases.

## 2.3 Learning Objective

At the end of reading this module the learner will be able to

1. Identify common skin diseases
2. Define each skin
3. Explain the etiologic agents and clinical manifestations of each disease
4. List the various diagnostic measures, in the diagnosis of common skin diseases
5. Manage cases presenting with skin diseases
6. Describe the epidemiology, control, and prevention of common skin diseases

## 2.4. Structures and functions of the skin

The skin is the largest organ in our body. It comprises about 15% of the body weight. It is composed of three layers: epidermis, dermis, and subcutaneous tissue (fat). The epidermis, the outer most layer is directly contiguous with the environment. It is formed by an ordered arrangement of cells called keratinocytes, the basic function of which is to synthesize keratin, a filamentous protein that serves a protective function.

The dermis is the middle layer, composed of collagen, tough and resilient part of the skin lies on the subcutaneous tissue which is principally composed of lobules of fat cells.

All skin is made up of these three layers. Although there is a considerable regional variation in their relative thickness: the epidermis is thickest on the palms and soles and very thin on the eyelids. The dermis is thickest on the back. The amount of fat is generous on the abdomen and buttock compared with the nose and sternum.

### Cells of the epidermis

**Keratinocyte** - produces keratin which forms the outer most skin layer covered by thin lipids to give the skin protective capacity from water and heat loss, penetration of microbial agents, and other trauma by physical mechanisms.

**Melanocytes** -they are the melanin (pigment) producing cell of the epidermis. Melanin prevents the skin from. The number of melanocytes in the epidermis is the same, regardless of the person's race or skin color; it is the number , shape and size of melanosomes (melanin containing granules) and the type of melanin that determine difference in skin color.

**Langerhans' cells** - these are cells with dendrite processes specialized in antigen processing and presentation (building immunity to infection). They are found in the epidermis but they constantly move as a result, they transport antigens to the regional lymph nodes and present them to naïve T lymphocytes in the regional lymph nodes and consequently the naive T lymphocytes become recruited to the specific antigen and the resultant immunologic response occurs. ("They take the offenders to the police station for investigation and appropriate response "). E.g. when a child receives BCG vaccination and develops a scar. In this way, the skin is very crucial part of the immune system because of the large surface area that it spans. Countless varieties of external antigens can be sensed by the immune system via the Langerhans' cells in the epidermis.

## 2.5 Physiological Functions of the Skin

**1. Display:** the skin as a display enables us to assume our own identity and to recognize among our selves and with out the skin emotional expressions wouldn't be possible.

**2. Protection:** it protects the body from many environmentally unfavorable factors; such as, thermal, chemical, ultra violet radiation and different disease-causing microorganisms. It also protects from unnecessary entry and egress of fluids into and from the body.

**3. Thermoregulation:** because it bears receptors to detect temperature, it conveys sensory input to the CNS so that the thermoregulatory centre can respond appropriately. The skin is a peripheral thermoregulatory organ through sweating, vasodilation, and shivering.

**4. Immunologic:** the skin is an end-organ for many immunologically mediated disorders as well as a tool for immunologic research. Because it bears immunologic

cells (lymphocytes, langerhans' cells, and mast cells) it has an active role in immunologic field of action. The skin can be viewed as a peripheral arm of the immune system involved in normal homeostasis and host defense.

**5. Synthetic function:** the skin synthesizes vitamin D, different hormones, melanin, and other substances.

## 2.6 Diagnosis

The diagnosis of skin disease is made by using the same general principle of clinical diagnosis. It begins by taking history, physical examination, and laboratory investigations when needed.

A proper skin examination should be performed in good light; preferably in day light. Ideally the whole skin should be examined.

**While describing skin lesions, the following features should be identified:**

Sites involved and distribution: - if lesions are affecting both sides of the body symmetrically, it probably could have an endogenous origin (e.g. eczema, psoriasis, acne ...) but if it involves predominantly one side of the body, usually it could be of external cause (e.g. bacterial, fungal, contact eczema).

**Erythematous or non erythematous.** Erythematous lesions are usually indicative of acute inflammation.

### Surface features

**Normal/ smooth:** the surface is not different from the surrounding skin and feels smooth

**Scaly:** dry/flaky surface due to abnormal stratum corneum with accumulation of or increased shedding of keratinocytes.

**Exudate:** serum, blood, or pus that has accumulated on the surface.

**Friable:** surface bleeds easily after minor trauma

**Crust:** dried serum, pus or blood

**Excoriation:** localized damage to the skin due to scratching.

**Lichenification:** thickening of the epidermis with increased skin markings due to persistent scratching.

**Umblicated;** surface contains a round depression in the centre, characteristics of molluscum contagiosum or herpes simplex.

### Primary lesions

**Macule:** flat lesion due to a localized color change only; the surface is normal (size <1cm)

**Patch:** similar to a macule but the size (> 1cm)

**Nodule:** any elevated lesion (> 1cm diameter) which has a round surface (i.e. the thickness is similar to the diameter): often due to dermal pathology

**Plaque:** (size > 1cm) a raised lesion where the diameter is much greater than the thickness

**Vesicle:** (size < 1cm) a fluid filled lesion (blister)

**Bullae:** blister which is > 1cm in size

**Pustule** when a vesicle contains pus and the size is < 1cm and if it is more than 1cm it is called **abscess**.

### Secondary lesions

**Erosion:** partial loss of epidermis, which will heal without scarring

**Ulcer:** full thickness loss of epidermis and some dermis, which will heal with scarring

**Atrophy:** depression of the surface due to thinning of the epidermis or dermis. There are often fine wrinkles and blood vessels easily seen under the skin.

**Fissure:** linear split in the epidermis or dermis at an orifice (angle of the mouth or anus), over a joint or along a skin crease.

# UNIT THREE

## SATELLITE MODULE FOR HEALTH OFFICERS

### **3.1. Purpose of the Module**

The ultimate purpose of this training module is to produce competent Health Officers who can correctly identify and effectively manage common dermatologic problems both in clinical and community settings.

### **3.2. Direction for Using the Satellite Module**

This satellite module can be used in the basic training of Health Center team particularly health officers who are in the training and service programs. In order to make maximum use of the satellite module, the health officer should follow the following directions.

**3.2.1.** Do the pretest for satellite module of Health Officers in section 3.5 and unit two of the core module

**3.2.2.** Check or read the core module very thoroughly

**3.2.3.** Read the case studies and try to answer questions pertinent to it

**3.2.4.** Use listed references and suggested reading materials to supplement your understanding of the problem.

**3.2.5.** For total and comprehensive understanding of the causes (etiology/pathogenesis) and prevention of common skin diseases, the Health Officer Students are advised to refer to the core module.



### 3.3. Significance and Brief Description of the Problem

See the part under unit 2 section 2.2 and 2.3 in the core module

#### 3.4. Learning Objectives

At the end of reading this module, the health officer student will be able to:

1. Classify common skin diseases by its cause.
2. Identify and describe the clinical manifestations and complications of skin problems.
3. List the diagnostic methods and procedures for a patient with skin problem
4. Describe the principles and methods of treatment for the commonly encountered skin diseases.
5. Select the appropriate treatment for a patient presented with a skin complaint in Ethiopia.
6. Identify and manage or refer timely, a patient with skin diseases when needed

### 3.5. Pre test for Health officers

#### Short answer Questions

1. Discuss the functions of skin in terms of
  - a) Protection
  - b) Thermoregulation
  - c) Immunologic function

- d) Synthesis
  - e) Others
2. What do you understand by the term skin failure (exfoliative dermatitis or erythroderma)?
- a) What disease entities could cause skin failure?
  - b) What are the pathphysiologic alterations which could be seen on a patient with skin failure?
  - c) Discuss how to care for this group of patients ( supportive and curative)
3. A two year old child presented with itchy, faintly papular eczematous lesions on both cheeks, forehead and neck. Excoriations and oozing were noted on the cheeks. Generalized dryness of the skin and lesions on the lateral aspects of the extremities were also seen. It started at the age of six months. The mother is a known asthmatic patient
- a. What is the most likely diagnosis
  - b. What are the major and minor features you would like to look for?
  - c. What would be the most likely distribution of the condition after a year or two?
  - d. How do you manage this child?
  - e. What is the prognosis?
4. Skin colored papules and nodules with shining surfaces and umblicated top were noted on a four year old child. When lesions were squeezed, cheesy matter came out.
- a) What is your most likely diagnosis?
  - b) Could it be acne? Why?
  - c) What is the causative agent
  - d) What are the commonest complications?
  - e) How would you like to manage the condition?
  - f) If you see this condition in adults, what else should you consider?
5. A six year old child presented with high fever, pain, and diffusely swollen left leg of two day duration. On examination of the limb; erythematous, grossly swollen, hot, and tenderness elicited with left side inguinal lymphadenopathy which was also tender. He had an abrasion to the left pretibial area ten days ago

- a. What are the differential diagnoses to be considered in the child?
- b. What is your most likely differential diagnosis in this child?
- c. How would you like to manage this child?

### **3.6. Bacterial infection of the skin (pyodermas)**

Bacterial skin infection is one of the commonly encountered problems in the tropics. When the normal protective functions of the skin are altered by trauma (scratching and excoriation ), pre existing and/or coexisting skin diseases like, eczema, scabies or venous or lymphatic insufficiency, pathogenic organisms get access to the skin to establish infection.

#### **3.6.1 Impetigo**

Impetigo is a contagious superficial (stratum corneum) pyogenic infection of the skin. Two main clinical forms are recognized: non-bullous impetigo (or impetigo contagiosa) and bullous impetigo.

Impetigo presents as either a primary pyodermal of intact skin or a secondary infection due to preexisting skin disease or traumatized skin. Impetigo rarely progresses to systemic infection, although post streptococcal glomerulonephritis may occur as a rare systemic complication.

Impetigo occurs in individuals of all ages. However, children younger than 6 years have a higher incidence of impetigo than adults.

Bullous impetigo is most common in neonates and infants

#### **Causative agents**

It is caused by *Staphylococcus aureus*.

The non-bullous form is usually caused by group A $\beta$  streptococcus, in some geographical areas *Staphylococcus aureus* or by both organisms together.

## Clinical features

### Non-bullous impetigo:

The characteristic lesion is a fragile vesicle or pustule that readily ruptures and becomes a honey-yellow, adherent, crusted papule or plaque and with minimal or no surrounding redness and usually occurs on hands and face. unless secondary infection exists (cellulites).

Lesions develop on either normal or traumatized skin or are superimposed on a preexisting skin condition (e.g., scabies, varicella, atopic dermatitis).

Lesions are located at exposed parts of the body (e.g., scalp, arms, legs), sparing the palms and soles. Localized lymphadenopathy usually is present, and nodes may be tender.

### Bullous impetigo:

The characteristic lesion is a vesicle that develops into a superficial flaccid bulla on intact skin, with minimal or no surrounding redness. Initially, the vesicle contains clear fluid that becomes turbid.

The roof of the bulla ruptures, often leaving a peripheral collarette of scale if removed; it reveals a moist red base.

## Management

*Local management for small lesions:* Wash with betadine solution or saline.

Potassium permanganate 1 in 1000 solution soaking twice a day until the pus exudates dry up.

Gentian violet (GV) paint 0.5% apply BID.

Topical antibiotics can be used, such as 2% mupirocin, Gentamycine, Fucidic acid can be used but costly.

*Systemic treatment* for impetigo contagiosa: a single dose of benzathin penicillin coupled with local care.

Oral amoxacyllin or Ampicillin can also be used.

*For Bullous impetigo:* cloxacillin 500 mg po QID for 7 to 10 days. In cases, with an allergy to penicillin, erythromycin can be given.

The underlining skin conditions such as eczemas, scabies, fungal infection, or pediculosis should be treated.

When impetigo is neglected it becomes ecthyma, a superficial infection which involves the upper dermis which may heal forming a scar..

### **3.6.2. Folliculitis**

It is an infection of the hair follicles. It occurs on hair bearing areas of the skin. Application of greasy substance such as Vaseline is a predisposition. The most common etiologic agent is staphylococcus aureus. However, fungi and virus can also cause it.

**A furuncle** is an acute, deep-seated, red, hot, tender nodule or abscess that evolves around the hair follicle and is caused by staphylococcus aureus.

**A carbuncle** is a deeper infection comprised of interconnecting abscesses usually arising in several adjacent hair follicles.

Furuncle and carbuncle are common in obese, diabetic patients and immunosuppressive conditions.

#### **Management of folliculitis**

Avoid greasy applications on the skin.

Mupiricine topically can be used.

Systemic antibiotics: - cloxacillin or erythromycin is choices of treatment.

For deep abscesses (furuncle and carbuncle) incision and drainage is mandatory.

### **3.6.3. Cellulitis and Erysipelas**

**Cellulitis** is bacterial infection and inflammation of loose connective tissue (dermis subcutaneous tissue)

**Erysipelas** is a bacterial infection of the dermis and upper subcutaneous tissue; characterized by a well-defined, raised edge reflecting the more superficial (dermal) involvement

## **Etiology**

The most common etiologic agent is group A  $\beta$  hemolytic streptococcus. However, *Staphylococcus aureus* can also cause cellulites. In young children, *Hemophilus influenzae* type B should be considered as a possible etiology for cellulites especially of the face (facial cellulitis).

## **Clinical features**

The difference between the conditions is often times fluid and more of academical. Except in mild cases, there is constitutional upset with fever and malaise. Classical erysipelas starts abruptly and systemic symptoms may be acute and severe, but the response to treatment is more rapid. Erythema, heat, swelling and pain or tenderness are constant features in both. In erysipelas, the edge of the lesion is well demarcated and raised, but in cellulitis it is diffuse.

In erysipelas, blisters are common and severe cellulitis may also show bullae or necrosis of epidermis and can rarely progress to fasciitis or myositis. Lymphangitis and lymphadenopathy are frequently associated with cellulitis.

The leg is the commonest site for cellulites. A skin break, usually a wound even if superficial, an ulcer, or an inflammatory lesion including interdigital fungal or bacterial infection, may be identified as a portal of entry.

Erysipelas may occur on the face or extremities and usually accompanied by malaise and fever.

## **Complications**

Without effective treatment, complications are common - fasciitis, myositis, subcutaneous abscesses, and septicemia. Pretibial cellulitis can result in osteomyelitis from contiguous spread. Post streptococcal glomerulonephritis can occur in some cases.

If Lymphangitis is not treated properly, it can lead to lymphoedema.

## Management

Treat the fever and pain and elevate the affected part.

Crystalline penicillin or procaine penicillin is the first line therapy and oral Ampicillin or Amoxicillin may be used for mild infection and after the acute phase resolves. The antibiotics should be continued for 10- 14 days.

*Follow up:*

- a) Response to the antibiotic
- b) For proper timing of surgical intervention.

### 3.6.4. Erythrasma

Erythrasma is a chronic superficial infection of the intertriginous areas of the skin. It is caused by over growth of *Corynebacterium minutissimum*, which usually is present as a normal flora of the skin.

A warm, humid climate, obesity and Diabetes is a predisposing factor. It is commonly seen among adults.

Among normal populations, mild toe-cleft scaling maceration is common.

Clinically manifest with pink, brown scaly macules or macerated white areas. It occurs most commonly in the groins, axillae and the intergluteal and submammary flexures, or between the toes.

In the groins, it affects the area of one or both thighs in contact with the scrotum. Dark faintly scaly patch on both sides of inner thigh with ill defined margins.

#### Differential diagnosis (DDx):

- *Pityriasis versicolor*

On the thighs, groins and pubic area, Tinea cruris may be simulated, but the relative lack of inflammation, complete absence of vesiculation and absence of satellite lesions point against Tinea.

It is difficult to differentiate erythrasma of the toe clefts from Tinea pedis or Candida infection.

Since most patients have both Candida and erythrasma, it may worsen if only one condition is treated.

## Treatment

Erythrasma responds well to most topically applied azole antifungal agents, such as 1% clotrimazole and 2% miconazole. The duration of therapy varies, but 2 weeks is usually sufficient for topical fucidin and erythromycin.

Oral erythromycin and tetracycline can also be used. Relapse is a problem in some patients. In these cases, the usual approach adopted is to give long-term antiseptic soaps, such as povidone-iodine and to use drying agents, such as powders, in the affected areas.

Advise the patient to take frequent bath.

### 3.7. Superficial fungal infection of the skin

Superficial fungal infections of the skin are one of the most common dermatologic conditions seen in clinical practice. Therefore, recognition is important for primary care physicians. However, making the correct diagnosis can be difficult, because these infections can have an atypical presentation or be confused with similar-appearing conditions.

Superficial fungal infections can be divided into three broad categories: dermatophytic infections, Pityriasis versicolor and cutaneous candidiasis

**3.7.1. Dermatophytes** specifically Trichophyton, Epidermophyton and Microsporum species, are responsible for most superficial fungal infections. The term "Tinea" refers exclusively to dermatophyte infections.

Dividing infections into the body region most often affected can help in identification of the problem.

**3.7.2. Tinea Capitis** Tinea capitis is a dermatophytic infection of the head and scalp, usually found in infants, children, and young adolescents. Most infections occur in preschool-aged children. Around puberty, sebum production by sebaceous glands becomes active, and as a result, it tends to disappear.

Commonest presentation is scaly patches on the scalp with variable degree of hair loss and generalized scaling that resembles seborrheic dermatitis may occur on the



scalp. Cervical lymphadenopathy can occur when there is secondary bacterial infection.

*Keroin* is a form of *Tinea capitis* with accentuated inflammatory response. It is boggy, nodular tender mass which may form pus.

An unusual scaling reaction known as favus may give the scalp a waxy or doughy appearance with thick crusted areas.

### **Differential diagnosis (DDx)**

Differential diagnosis of *Tinea capitis* includes seborrheic dermatitis, dandruff, scalp psoriasis, atopic dermatitis, scalp impetigo, and alopecia areata. The finding of large areas of alopecia that have early pustule formation favors a diagnosis of *Tinea capitis* over alopecia areata.

### **Investigation**

KOH preparation and looking for the fungal elements from skin scraping, nail or hair.

### **Treatment**

*Tinea capitis* should be treated with systemic therapy. Griseofulvin in a dose of 10-20 mg per kg for six weeks to 8 weeks is the first-line treatment of *Tinea capitis*.

Ketoconazole 2-4mg per kg for ten days, itraconazole and terbinafine (Lamisil) are good alternatives.

Griseofulvin should be taken after fatty meal. Topical treatment can be added to decrease the transmission and accelerate resolution.

Whitefield ointment is preferred in the absence of secondary bacterial infection.

Other family members should also be examined and treated.

### 3.7.3. Tinea corporis

Tinea corporis is dermatophytosis of the glabrous skin of the trunk and extremities. Lesions are round, scaly patches that have a well defined, enlarging border and a relatively clear central portion. The active edge often contains follicular papules. Itching is variable and not diagnostic

Tinea corporis can assume a giant size (Tinea incognito) when steroids are applied for cosmetic reasons or as a result of miss diagnosis.

**Differential Diagnosis (DDx)** Lichen simplex chronicus, numular eczema, atopic eczema, psoriasis, lichen planus.

#### Investigation

KOH from active edge of lesion.

Culture for fungus only in doubtful cases if the KOH is negative.

#### Treatment

Small and single lesion can be treated with topical agents. Clotrimazole 1%, ketoconazole 2%, meconazole 1%. BID for two weeks

Systemic: ketoconazole 2-4mg per kg of weight for 10 days. Itraconazole and fluconazole are choices if available. Griseofulvin is also effective for the treatment of Tinea corporis.

### 3.7.4. Tinea pedis

Tinea pedis is fungal infection of the feet and is usually related to sweating and warmth, and use of occlusive footwear. Men between 20 and 40 years of age are most frequently affected.

The infection often presents as white, macerated areas in the 3<sup>rd</sup> or 4<sup>th</sup> toe webs. It may also present with a classic pattern on the dorsal surface of the foot or as chronic dry, scaly hyperkeratosis of the soles and heels. Itching is also common with vesicular or bullous lesion.

It is transmitted by direct contact or sharing of shoes, towels or bath.

## **Treatment**

Topical anti fungal creams or ointments applied regularly for 4 - 6 wks.

Systemic treatments provide better skin penetration than most topical preparations, Itraconazole, terbinafine and griseofulvin are good choices for oral therapy.

Itraconazole and terbinafine are more effective than griseofulvin. Once-weekly dosing with fluconazole is another option, especially in noncompliant patients.

Personal hygiene (foot hygiene) is highly advised.

### **3.7.5. Tinea versicolor (Pityriasis versicolor)**

Versicolor versicolor is a common, benign, superficial cutaneous (stratum corneum) fungal infection at the level of stratum corneum characterized by hypo pigmented or hyperpigmented macules and patches with faint scale on the chest and the back.

**Etiology:** *Malassezia furfur* (*Pityrosporon ovale*,)

*M furfur* is a member of normal flora of the skin found in 18% of infants and 90-100% of adults. Predisposing factors include - genetic predisposition, warm, humid environments, excessive sweating, immunosuppression, malnutrition, and Cushing disease.

## **Investigation**

The clinical presentation of Pityriasis versicolor is distinctive, and the diagnosis is made without potassium hydroxide (KOH) examination.

## Treatment

Patients should be informed that it is caused by a normal flora of the skin hence it is not transmitted and any skin color alterations resolve within 1-2 months after treatment. Recurrence is common if the patient is not given enough dose of treatment..

Effective topical agents include: Sodium thiosulphate solution, selenium sulfide and azole, ciclopiroxolamine, and allylamine antifungals.

Topical azole antifungals (clotrimazole, ketoconazole meconazole) can be applied every night for 2 weeks. Weekly applications of any of the topical agents for the following few months may help prevent recurrence.

Systemic treatment is also effective and is often preferred by patients because of convenience. Ketoconazole 200-mg daily for 10-days and as a single-dose 400-mg treatment, have comparative results. Oral therapy does not prevent the high rate of recurrence, unless repeated on an intermittent basis throughout the year.

### 3.7.6. Candidiasis

Candida infections caused by yeast-like fungi *Candida albicans* commonly occur in moist, flexural sites. These fungi live on all surfaces of our bodies. Under certain conditions, they can become so numerous that they cause infections, particularly in warm and moist areas.

#### **The factors associated with increased colonization rates.**

- ❖ Broad-spectrum antibiotics by compromising the mucocutaneous protective bacterial flora
- ❖ Depressed cell-mediated immunity either acquired or congenital
- ❖ Diabetes mellitus
- ❖ Systemic corticosteroid treatment
- ❖ Hematological malignancies and solid tumors
- ❖ Severe traumas and burns
- ❖ Premature birth

Three of every four women have at least one bout of vulvovaginal candidiasis (VVC) during their lifetime.

More than 90% of HIV positive patients experience oropharyngeal candidiasis (OPC), and 10% have at least one episode of esophageal candidiasis.

Candidal colonization is at the highest levels during the extremes of ages, in neonates and people older than 65 years

**Intertrigo:** affects any site where the skin surfaces are in close proximity with warm and moist environment. Pruritic rash that begins with vesiculopustules, which enlarge and rupture, causing maceration and fissuring. Satellite lesions frequently are found that may coalesce and extend into larger lesions.

**3.7.7. Paronychia and onychomycosis:** Frequently, paronychia and onychomycosis are associated with immersion of the hands in water. Patients present with a painful and erythematous area around and underneath the nail and nail bed, warm, glistening, tense, and tender. There is secondary nail thickening, ridging, discoloration, and occasional nail loss in chronic cases.

## **Mucosal candidiasis**

### **Oropharyngeal candidiasis (OPC)**

Symptoms include: asymptomatic, sore, and painful mouth, burning mouth or tongue, dysphagia, whitish thick patches on the oral mucosa. When removed show erythematous base.

Physical examination reveals a diffuse erythema and white patches that appear on the surfaces of the buccal mucosa, throat, tongue, and gums. The presence of retrosternal pain, epigastric pain, nausea, and vomiting may suggest esophageal candidiasis

**Vulvovaginal candidiasis:** This is the second most common cause of vaginitis. The patient's history includes vulvar pruritus, vaginal discharge, dysuria, and dyspareunia. The vagina and labia are erythematous, with a thick curd like discharge.

**Candida balanitis:** Candida balanitis is acquired through sexual intercourse with a partner who has vulvovaginal candidiasis. A patch resembling thrush appears on the glans and may spread to the thighs, gluteal folds, buttocks, and scrotum.

### Investigation

Wet mount: for hyphae, pseudohyphae, or budding yeast cells.

KOH smear: to demonstrate fungal elements.

### Treatment

**Candida intertrigo** - Topical azoles and polyenes, including clotrimazole, miconazole, and nystatin, are effective. Keeping the infected area dry is important.

**Paronychia** - the most important intervention is drainage followed by oral antifungal therapy with either ketoconazole, fluconazole or itraconazole. Single daily dose of itraconazole taken for 3-6 months or a pulsed-dose regimen that requires a slightly higher dose daily for 7 days, followed by 3 weeks off therapy. The cycle is repeated every month for 3-6 months.

**Oropharyngeal candidiasis (OPC):** - Topical (nystatin, clotrimazole, amphotericin B oral suspension) or systemic oral azoles (fluconazole, itraconazole, ketoconazole).

**Vulvovaginal candidiasis** – Azole suppository or pessaries, in resistant case systemic therapy for 10 days. Imidazole cream topically for 3 – 7 days with 1 dose of 150mg Fluconazole P.O.

## 3.8. Viral infections

### 3.8.1. Warts

Warts or verrucae are benign growths on the skin or mucous membranes that cause cosmetic problems as well as pain and discomfort. They are seen on people of all ages but most commonly appear in children and teenagers.

The etiologic agents are various strains of Human papilloma virus (HPV). The incubation period of a wart is 2 to 9 months during which time an excessive proliferation of skin growth slowly develops. They can be spread by direct or indirect contact or autoinoculation. The hosts' immunity clears the warts within two years in 2/3 of the cases so treatment is often unnecessary

Most types of HPV have an affinity for the skin and produce common warts (*verruca vulgaris*), flat warts (*verruca plana*), and plantar or foot warts (*verruca plantaris*). Several other types of HPV have an affinity for mucous membranes and some of these cause ano-genital warts (*condyloma acuminata*) which is mostly sexually transmitted infection. Certain strains of HPV increase the risk of cervical cancer.

In immunodeficiency states warts can become fulminantly wide spread and difficult to treat.

There is no single effective treatment for warts. Management is based on the age of the individual as well as the size, number, and location of warts. Common warts, especially in children, do not necessarily need to be treated, because they exhibit a high rate of spontaneous remission. Without treatment, however, spread can occur.

#### Treatment

- ❖ Salicylic acid 25% ointment twice daily followed by cutting or scraping
- ❖ Preparation of salicylic acid 5-20% and lactic acid 5-20 in collodion are easier to use
- ❖ Electrodesiccation and curettage
- ❖ Freezing with liquid nitrogen if available.

### **For genital warts**

- ❖ Podophyllin 10-25% solution. Protect the skin around the wart with Vaseline apply the podophyllin with a match stick carefully on the top of the war and wash after 6 hours. Repeat every week. It is contraindicated in pregnancy.
- ❖ Phenol 80% can be used in the same fashion to Podophyllin.
- ❖ Cauterization
- ❖ Topical 5% 5-fluoro-uracil cream (efudex)
- ❖ Cryotherapy with liquid nitrogen

### **3.8.2. Molluscum contagiosum**

Molluscum contagiosum is a viral infection of the skin that causes discrete papules that may be mistaken for warts.

**Etiologic agent:** Pox virus

It is common in children and some time in immunocompromised adults. The rash of molluscum contagiosum is characterized by discrete, 2 to 5 mm papules that are flesh-colored (skin color) and dome-shaped with a central umbilication (depressed centre). In children, the rash is most often found on the face, trunk and extremities.

In adults it appears in the pubic and genital region it is a sexually transmitted infection. Molluscum contagiosum is a self-limited disease, meaning it will eventually go away on its own. Each lesion generally lasts for about 6 to 9 months, but they can last for several years.

#### **Treatment**

In children not touching it is probably the best approach.

Cryosurgery - Using liquid nitrogen to freeze the lesion

Salicylic Acid (Compound W) - A solution applied to the lesion with or without tape occlusion

### **3.8.3. Herpes simplex Infection**

One of the most prevalent infections worldwide

The infection is life long



It affects:

- Skin
- Mucous membrane
- CNS

**Etiologic Agents:** - Herpesvirus hominis

HSV 1 and HSV 2 50% homology

HSV 1 – orolabial herpes (commoner), 50% give Hx of lesions

HSV 2 – genital herpes (*herpes progenitalis*) -20% are asymptomatic

-20% have recurrent genital ulcer

-60% subclinical (unrecognizable)

**Mode of Transmission:**

HSV 1 - Oral secretions or directly from the lesions

HSV 2 – Sexual contact after sexual activity is started

- Through birth canal neonatal infection

- May imply child abuse if it is found in children

HSV 1 and HSV 2 can infect and reactivate the same anatomical area.

### 3.8.4. Pathogenesis:

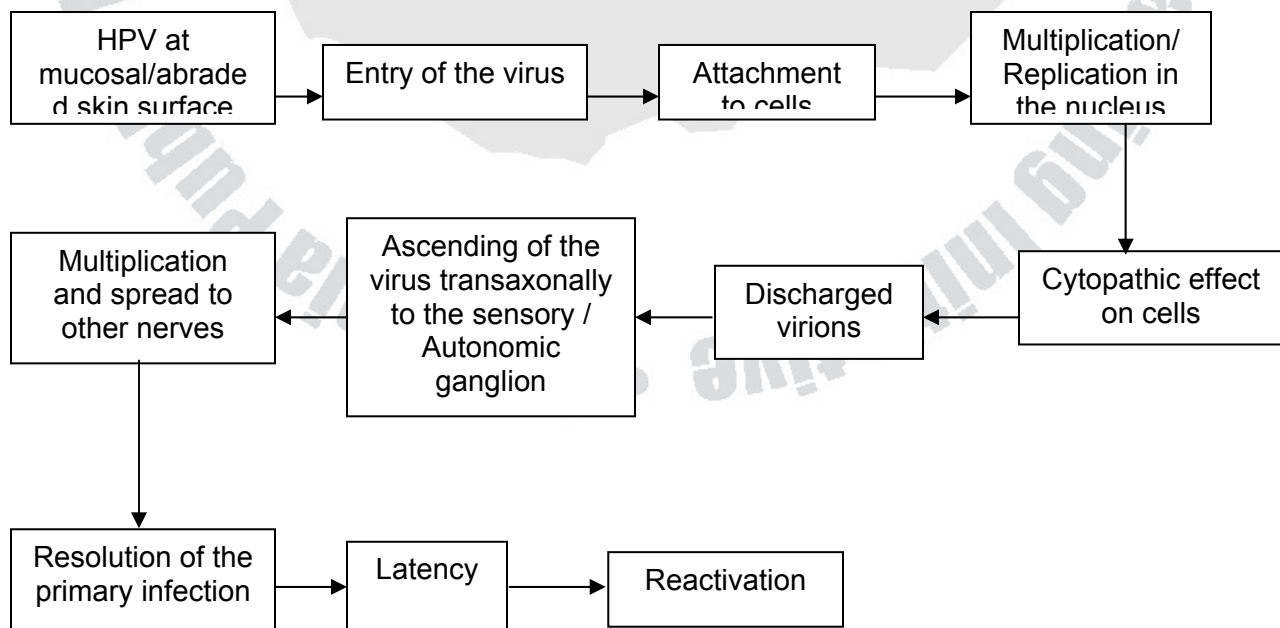

Fig 1 Pathogenesis of herpes simplex virus

Primary infection }  
Latency } Transmission can occur in all stages; more at the primary  
Reactivation } stage

### What causes latency?

What causes reactivation? (Precipitating factors)

- Local/systemic immuno-suppression
- Trauma to the skin site or ganglion
- UV rays
- Fever
- Immunity to HSV infection: - Both CMI and Humeral, but CMI is much more important to protect from a lethal disease, the severity of the infection and frequency of recurrence and latency

### Epidemiology:

Most of the infections are sub clinical which makes serology very important to assess the epidemiology = seroepidemiology

**HSV – 2:** The worldwide prevalence is increasing.

- The major cause of genital ulcer disease worldwide
- Very infectious and infection is lifelong.
- Asymptomatic infection and transmission possible.
- Forms a positive loop hole with HIV infection (co infection with HIV virus)

The prevalence of HSV - 2 is higher in developing countries:

- ✓ Urban than rural
- ✓ In sub-Saharan Africa and Caribbean 50% in adults
- ✓ Overall prevalence higher in women than in men (5 – 10% higher)
- ✓ It starts with sexual activity and with younger age at first age.
- ✓ Seropositivity increases with years of sexual activity.
- ✓ Also increases with number of lifetime partners
- ✓ Lack of circumcision in males
- ✓ Current or recent sexually transmitted infection (STIs)

### 3.8.5. HSV and HIV Bi-directional Interaction:

HIV and HSV2 manifest a bi-directional interaction. HSV2 increases the efficiency of HIV acquisition and transmission whereas HIV may increase susceptibility to HSV2 and increase HSV2 shedding, HSV2 recurrence rate and severity of clinical manifestations.

### 3.8.6. Orolabial Herpes

Lesions on the lips and face = HPV – 1, the initial infection is usually asymptomatic

Gingivostomatitis occurs chiefly in children and young adults, most often just like bacterial tonsilopharyngitis The most common form of orolabial herpes is cold sore or fever blister caused by recurrent HSV1 (95%).

**Manifestations:-** Grouped blisters on erythematous base on the lips, cheeks, eyelids, intraoral.

Prodromal symptoms:- tingling, burning, itching in 24 hrs. In most patients recurrent orolabial herpes is more a nuisance than a disease.

#### Treatment

**Lips:** In our setting Gential, violet 0.5% is effective and if available sunblocks reduces recurrence. Eg. Zinc oxide paste , zinc oxide ointment or zinc oxide and topical antiseptic or antibiotic e.g betadine ointment 3 times daily for bacterial super infection. For recurrent infections Acyclovir 200mg PO for 5 days can be given.

### 3.8.7. Herpetic Whithlow

Infection of pulp of fingertips, it could appear after touching a primary lesion of ones own lesion or that of others.

In children – HSV – 1, Adults – HSV – 2, common in females

Health workers may acquire and transmit it.

### 3.8.8. Genital Herpes (herpes progeneralis)

Usually due to HSV - 2 causing 85% (>15% can be caused by HSV -1) of initial infections and up to 98% of recurrent lesions

In the mid 1980's because of the change in the sexual behavior, the prevalence of HSV – 1 began to increase. In developed countries up to 40% of the anogenital herpes in women is caused by HSV – 1

HSV – 1 is associated with less recurrence rate than HSV – 2

**Genital herpes** → transmitted by skin-to-skin contact

Incubation Period: 5 days

Asymptomatic shedding occurs in all sites (vagina, cervix, and mucous membranes) even through normal appearing skin and mucous membranes.

Grouped blisters and erosions in the vagina, vulva, penis ... continues to develop in 7 – 14 days. Lesions are bilateral and symmetrical, inguinal lymph nodes may be enlarged, fever and flu like symptom may be there. Pain, dysuria, and dysparunia may also be observed.

Previous HSV – 1 lessens the severity resembling recurrent genital herpes.

Most HSV – 2 will have recurrence even if the initial infection was asymptomatic which is estimated to be 6 times more frequent than HSV – 1

#### **Recurrence:**

*Nature:* 24 hrs prodromal symptoms → 24 hrs vesicles appear → 24 – 36 hrs ulceration → 2 – 3 days healing: TOTAL: 7 days recurrence

*Sites and clinical presentation:*

- ✓ Genitalia and upper buttocks are the common sites for occurrence
- ✓ Healing without scar
- ✓ Social stigma – the emotion from recurrent lifelong disease
- ✓ Guilt
- ✓ Blamefulness of the presumed source (i.e. partner)

#### **Frequency:**

6 – 12 times a year → deserve prophylaxis

### **Treatment of Genital herpes**

Betadine or potassium solutions sitz baths 3 times daily. Gentian violet 0.5%, Zinc oxide and castor oil to soothe. Alternatively betadine ointment or oxytetracycline ointment 3 times daily.

Acyclovir cream can also be given 5 times daily.

Severe infections or infection in immunodeficient patients: if available give acyclovir 200 -400 mg 5 times daily for 5-10 days

OR

Famciclovir 250mg orally three times a day for 7--10 days,

OR

Valacyclovir 1 g orally twice a day for 7--10 days.

### **3.8.9. Neonatal Intrauterine**

HSV -2 - 70%

HSV -1 - 30%

Intrauterine: Rare but devastating neonatal infection, encephalitis

Risks: active lesion in the mother (30 – 50% rate of acquisition)

Recurrence: 2 – 5%

In all cases, CS delivery is mandatory.

Manifestations: Skin vesicles, Encephalitis, Hepatitis, Pneumonia, Coagulopathy

Mortality rate (M/R) >50% in ideal setting.

Without skin infection, it is difficult to diagnose.

### **3.9. Scabies**

**Definition:** - scabies is one of the commonest intensely pruritic, highly contagious infectious conditions of the skin caused by a mite *Sarcoptes scabiei* and transmitted by close personal and sexual contacts

### **Historically**

It has been recognized as a disease for over 2500 years. In 1687 Francesco Redi identified *Sarcoptes scabiei*. Scabies is one of the first diseases with a known cause.

In Latin, scabere means to scratch. Romans used the term to describe any pruritic skin disease; so, it has been known as the great imitator

### **Etiologic agent**

*Sarcoptes scabiei* var. *hominis*, the female measures 0.4mm long and 0.3mm broad and the smaller male is 0.2mm long and 0.15 mm broad.

### **Epidemiology**

- ✓ Commoner in children and adolescents
- ✓ It is a disease of disadvantaged community
- ✓ Epidemic occurs during wars and social upheavals
- ✓ Endemic in many developing countries

### **Transmission Pathogenesis**

Female and male mate on the surface of the skin. The male mite dies and the gravid female mite burrows into the epidermis lays up to 3 eggs per day for the duration of her 30-60 day lifetime.

- In a typical infestation host harbors 8-11 adult female mites. The eggs hatch in 3-4 days and the larvae leave the burrow to mature on the skin.
- ◆ Fewer than 10% of the eggs laid result in mature mites.
- ◆ Type IV hypersensitivity reaction to the mites, their eggs, or scybala (packets of feces) occurs approximately 30 days after infestation

### **Clinical features**

#### **Classic scabies:**

The lesions are erythematous, excoriated, papulovesicular and found bilaterally. It starts on the wrist, finger webs and on the medial sides of fingers, the flexor aspect of the wrist, the elbows and the anterior axillary folds, the genitalia and inner thighs and the gluteal folds

More disseminated presentation in infants and toddlers.

### **Scabies in infants and young children**

- ✓ Distribution and morphology:- generalized
- ✓ The face the scalp, palms an soles are affected
- ✓ Papules, vesicle and pustules
- ✓ Secondary eczematization and impetiginazation are common

### **Crusted (Norwegian) scabies**

In 1848, Danielssen and Boeck described a highly contagious variant of scabies occurring in immunocompromised patients, elderly or mentally incompetent patients. Thousands to million mites are found instead of the normal 8-11 mites in the normal host. But 2-3% of HIV/ AIDS patients manifest Norwegian scabies.

In Norwegian scabies, pruritus may not be there (in about 50% of the cases do not itch) It is psoriasiform and generalized with nail changes and scalp involvement Skin becomes thickened and involves all part of skin including face, palms and sales.

**DDX** Acropustulosis of Infancy, Atopic Dermatitis, Contact Dermatitis ....

### **Diagnosis of scabies**

- Itching, worse at night
- Presence of similar condition in the family or intimate contacts
- Characteristic distribution of lesions
- Demonstration of the mite, eggs or feces
- Therapeutic test

### **Management**

- Treat with a scabicide agent
- All family members and close contacts should receive treatment at the same time
- Provide antihistamines to alleviate pruritus.
- Treatment of secondary infections.
- For crusted scabies, crust and scale impair scabicide penetration.
- Bed linens, clothing, and towels should be washed in a warm cycle (Dry in sun).

- Infected individuals should avoid skin-to-skin contact with uninfected individuals.
- Decontamination of clothing, bed linens, etc, must coincide with medical treatment
- Trim finger nails

### **Scabicide agents**

- ❖ Lindane (gamma benzene hexachloide) 1% lotion or cream – single application
- ❖ Benzyl benzoate 25% lotion – for 3 consecutive days
- ❖ Permethrin (Elimite) -- 5% cream – single application
- ❖ Crotamiton (Eurax) -- 10% lotion or cream - 2 times daily for 10 days
- ❖ Sulfur in petrolatum -- 10% - for 07 days
- ❖ Ivermectin - 9-18 mg PO in 2 doses, 1 wk apart 200 mcg/kg twice - effective for common as well as crusted scabies in epidemic outbreaks

### **Method of application**

- Apply neck to toe, to Benzyl benzoate lotion advice not to wash between applications
- Advice to reapply if hands are washed during the day.

### **Complications of scabies**

Bacterial super infection

Eczematization

Nodule formation

Urticaria

**Treatment of complications:** - Use antibiotic and anti histamine.

### **Causes of therapeutic failure**

Improper counseling

Poor compliance of patient

Inadequate application

Improper application

Not treating family members who have close contacts



### **3.10. Eczemas**

Eczemas are groups inflammatory skin conditions manifesting either as acute eczematous lesions, which are characterized by active papules; erythema, excoriations and oozing (weeping), sub acute eczemas, also have excoriation, erythema with papules and scales or as a chronic eczematous lesion, characterized by thickening of the skin, and accentuation of the creases (lichenification) and hyperpigmentations

#### **3.10.1. Atopic dermatitis**

The term atopy is a Greek word meaning "out of place" or strange. The hereditary tendency to develop allergies to food and inhalant substances as manifested by eczema, asthma and hay (allergic conjunctivitis and allergic rhinitis) fever is called atopy.

The prevalence of atopic diseases appears to be rising. Atopic dermatitis now affects about 10 to 20% of the population.

It is the interaction of genetics and environmental factors that results atopic eczema. More than ¼ of the offsprings of atopic mother develop atopic dermatitis in the first 3 months of life. If one parent is atopic, more than 50% of the children would develop allergic symptoms by the age of two years and if both parents are affected, the chance of the child to have allergic symptoms would be about 79%.

#### **Diagnostic Criteria for Atopic Dermatitis**

The diagnosis of atopic eczema is made by constellation of criteria.

**Major criteria: one should have three of the following major criteria.**

1. pruritus
2. typical morphology and distribution
  - A. flexural lichenification in adults
  - B. facial and extensor involvement in children
3. chronic or chronically relapsing dermatitis
4. personal or family history of atopic diseases (asthma , allergic rhinitis, allergic conjunctivitis and atopic eczema )

### **Minor Criteria One Must Have Three of the Following**

- ✓ Dryness of the skin (xerosis, xeroderma)
- ✓ Ichthiosis/hyperlinear palms and soles
- ✓ IgE reactivity
- ✓ Elevated serum IgE
- ✓ Early stage of onset
- ✓ Tendency to cutaneous infection
- ✓ Pityriasis alba
- ✓ Itching when sweating
- ✓ Intolerance to wool and lipid solvents perifollicular accentuation

### **For young infants the diagnostic criteria is modified**

- ❖ The three major criterias are
  1. family history of atopic diseases
  2. Typical facial or extensor dermatitis
  3. Evidence of pruritus
- ❖ Three minor features are:
  - Xerosis/ ichthiosis / hyperlinearity of palms and soles
  - Perifollicular accentuation
  - Post auricular fissure
  - Chronic scalp scaling

The hall mark of atopic eczema is pruritus and dryness of the skin. Long standing pruritus results in lichenified dry skin which would call for further scratching and in this way the itch -scratch cycle establishes which assumes a vicious form. The flexures like the popilitial fossa, wrist, and anticubital fossa are affected.

The pattern of distribution in atopic eczemas depends on the age and activity of the disease. Based on that atopic eczemas are classified in to: infantile eczema (from 2 months up to 2 years), childhood atopic eczema (from 2 years to 10 years) and atopic eczema of adolescents and adults.

## **Infantile Atopic eczema**

Atopic dermatitis usually starts in the first year of life. During this phase, there is facial erythema, vesicles, oozing and crusting located mainly on the face, scalp, forehead and extensor surface of the extremities. Buttocks and diaper area are frequently spared.

### **Childhood eczema:**

The lesions tend to be drier and scaly. Flexor surfaces and skin creases are predominantly involved. Facial lesions with eyelid involvement and lesions around the neck also occur. Lichenification from chronic itching and scratching occur over flexor surfaces. Psychological effects often are very prominent

### **Adolescent and adult atopic dermatitis:**

Flexural predilection of lesions persists. Localized, eczematous or lichenified plaques often predominates the clinical picture. Prurigo papules and nodules tend to occur. Resolved cases show dryness and irritability of the skin with a tendency to itch with sweating and other triggers. Recurrent and persistent hand dermatitis is a frequent feature.

## **Treatment**

### **General Measures**

- ✓ Counseling; that it is not curable but controllable by treatments;
- ✓ Avoidance of factors that promotes dryness, itching or inflammation, such as excessive bathing and exposure to volatile chemicals (gasoline, kerosene)
- ✓ Avoidance of contact with local irritants like woolen garments; use soft cotton garments.
- ✓ Clothing and linens should be washed in mild detergents and rinsed well.
- ✓ Soaps should be used when they are necessary
- ✓ In severe cases, hospitalization for a short period may promote rapid reduction of symptoms mainly by providing a changed environment

## Specific

Specific measures are aimed at modifying the following pathogenetic factors: dryness, inflammation, infection, and itching.

## Topical Steroids

High potency steroids are used for a short period to rapidly reduce inflammation.

However they should not be used on the face.

Maintenance therapy, if needed is best done with mild steroids like hydrocortisone.

On face and intertriginous areas, mild steroids should be used; mid-potency formulations are used for trunk and limbs.

Topical steroids are applied initially twice or thrice a day after the symptoms are lessened, frequency of application should be reduced. Intermittent use of topical steroid may be alternated with application of emollients. Ointments are superior to creams or lotions.

**Systemic steroids:** a short course of systemic steroids (prednisolone, triamcinolone) may occasionally be needed to suppress acute flare-ups

Emollients – liquid paraffin, Vaseline, olive oil used after bath

*Antihistamines* - Non-sedating antihistamines like cetirizine, loratadine or fexofenadine may be used to alleviate pruritus .

Infections and colonization with *Staphylococcus aureus* may aggravate or complicate Atopic dermatitis Erythromycin, or cloxacillin is usually prescribed Course and prognosis

Most infantile and childhood cases improve over time and the prevalence of atopic dermatitis diminishes significantly in older ages. Children tend to outgrow the condition. Some patients' disease may persist through adulthood. In others, a tendency for dry and irritable skin that easily develops eczematous changes may persist after AD resolves. A propensity for recurrent hand dermatitis may

remain in adults who had AD in their childhood. Many children later on develop allergic rhinitis or bronchial asthma.

### **3.10.2. Seborrheic Dermatitis**

Seborrheic dermatitis is a papulosquamous disorder patterned on the sebum-rich areas of the scalp, the face, and the trunk. In addition to sebum, this dermatitis is linked to *Pityrosporum ovale*, immunologic abnormalities, and activation of complement. It is commonly aggravated by changes in humidity, trauma (eg, scratching), seasonal changes, and emotional stress. The severity varies from mild dandruff to exfoliative erythroderma. Seborrheic dermatitis may worsen in Parkinson disease and in AIDS.

Seborrheic dermatitis is associated with normal levels of *P ovale* but an abnormal immune response.

The incidence of seborrheic dermatitis is 3-5%, with a worldwide distribution. In infants, it occurs as cradle cap or commonly as a flexural eruption or rarely as erythroderma.

#### **Clinical presentation**

Skin lesions present as greasy scale over red, inflamed skin. Infectious eczematoid dermatitis, with oozing and crusting, suggests secondary infection. A seborrheic blepharitis may occur independently.

Distribution follows the oily and hair-bearing areas of the head and the neck, such as the scalp, the forehead, the eyebrows, the lash line, the nasolabial folds, the beard, and the postauricular skin. Presternal or interscapular involvement is more common than the nonscaling intertrigo of the umbilicus, axillae, inframammary and inguinal folds, perineum, or anogenital crease that may also be present.

*Pityrosporum* organisms are probably not the cause but a cofactor linked to a T-cell depression, increased sebum levels, and an activation of the alternative complement pathway.

Because seborrheic dermatitis is uncommon in preadolescent children, and Tinea capitis is uncommon after adolescence, dandruff in a child is more likely to represent a fungal infection. Commonly seborrheic dermatitis is secondarily infected by bacteria.

## **Treatment**

Topical corticosteroids, creams, lotions

Systemic ketoconazole or shampoos can be given if it is severe.

Dandruff responds to more frequent shampooing. Salicylic acid, tar, selenium, sulfur, and zinc all are effective in shampoos and may be alternated. Selenium sulfide (2.5%) or ketoconazole shampoos may help by reducing *P. ovule* scalp reservoirs. When severe Ketoconazole 200mg tab can be given for 2 to 3 weeks and Antibiotics if it is infected

### **3.10.3. Lichen Simplex Chronicus**

Lichen simplex chronicus (LSC) is thickening of the skin with variable scaling that arises secondary to repetitive scratching or rubbing. LSC is not a primary process. Rather, a person senses pruritus in a specific area of skin (with or without underlying pathology) and causes mechanical trauma to the point of lichenification.

LSC is found on the skin in regions accessible to scratching. Pruritus provokes rubbing that produces clinical lesions, but the underlying pathophysiology is unknown. A relationship likely exists between central and peripheral neural tissue and inflammatory cell products in the perception of itch and ensuing changes in LSC. The possible interplay among primary lesions, psychic factors, and the intensity of pruritus additively influence the extent and severity of LSC

Pruritus is usually described as much worse during periods of inactivity, usually at bedtime and during the night. Touch and emotional stress also may provoke pruritus, which is relieved by moderate-to-severe rubbing and scratching.

LSC occurs mostly in mid-to-late adulthood, with highest prevalence in persons aged 30-50 years.

- ✓ Scalp, Nape of neck,
- ✓ Extensor forearms and elbows
- ✓ Vulva and scrotum
- ✓ Upper medial thighs, knees, lower legs, and ankles

lichenified, firm, rough plaques with exaggerated skin lines are noted.

Pigmentary changes (especially hyperpigmentation) are seen variably as in any dermatitic lesion.

Treatment is aimed at reducing pruritus and minimizing existing lesions because rubbing and scratching cause LSC.

Topical steroids are the current treatment of choice because they decrease inflammation and itch while concurrently softening the hyperkeratosis. Because lesions are by nature chronic, treatment most likely is very long.

Occasionally, occlusion is used to increase potency and enhance delivery of the steroids and also provides a physical barrier to the scratching.

Keratolytes (2% - 3% Salicylic acid) could be used in lichenified lesion to remove the hyperkeratosis.

### **3.11. Acne vulgaris**

Acne vulgaris is a common skin disease that affects 85-100% of people at some time during their lives. It is characterized by noninflammatory follicular papules or comedones and by inflammatory papules, pustules, and nodules in its more severe forms. Acne vulgaris affects the areas of skin with the densest population of sebaceous follicles; these areas include the face, the upper part of the chest, and the back.

Four key factors are responsible for the development of an acne lesion:

1. **Follicular epidermal hyperproliferation and hyperkeratinization**, the increased level of adrenal derived androgen, dehydroepiandrosterone sulfate induces hyperproliferation.
2. **Excess sebum**, - Excess sebum is also a key factor in the development of acne vulgaris. The amount of sebum produced and the degree and the severity of the acne are strongly correlated. Sebum excretion is under hormonal control. Androgens stimulate sebocyte differentiation and sebum production, whereas estrogens have an inhibitory effect. Most men and women with acne have normal circulating levels of androgen hormones. An end-organ hyperresponsiveness to androgens has been hypothesized.
3. ***Propionibacterium acnes***, - *P acnes* is a microaerophilic organism present in many acne lesions. *P acnes* stimulate inflammation by producing proinflammatory mediators that diffuse through the follicle wall.
4. **Inflammation** - Inflammation may be a primary phenomenon or a secondary phenomenon and plays a role in the development of acne comedones, papules, pustules, and nodules in a sebaceous distribution characterize acne vulgaris. The face may be the only involved skin surface, but the chest, the back, and the upper arms are often involved
5. **Genetic predisposition** – but mode of inheritance is unknown
6. **Mechanical factors** – excessive rubbing of the skin and use of oily cosmetics may induce acne lesion.

An external cause is seldom identifiable in acne vulgaris. Some cosmetic agents and hair pomades may worsen acne.

Medications that can promote acne include steroids, lithium, some antiepileptics, and iodides.

Congenital adrenal hyperplasia, polycystic ovary syndrome, and other endocrine disorders with excess androgens may trigger the development of acne vulgaris. Acne vulgaris may also be influenced by genetic factors.



## Normal Pilosebaceous Unit

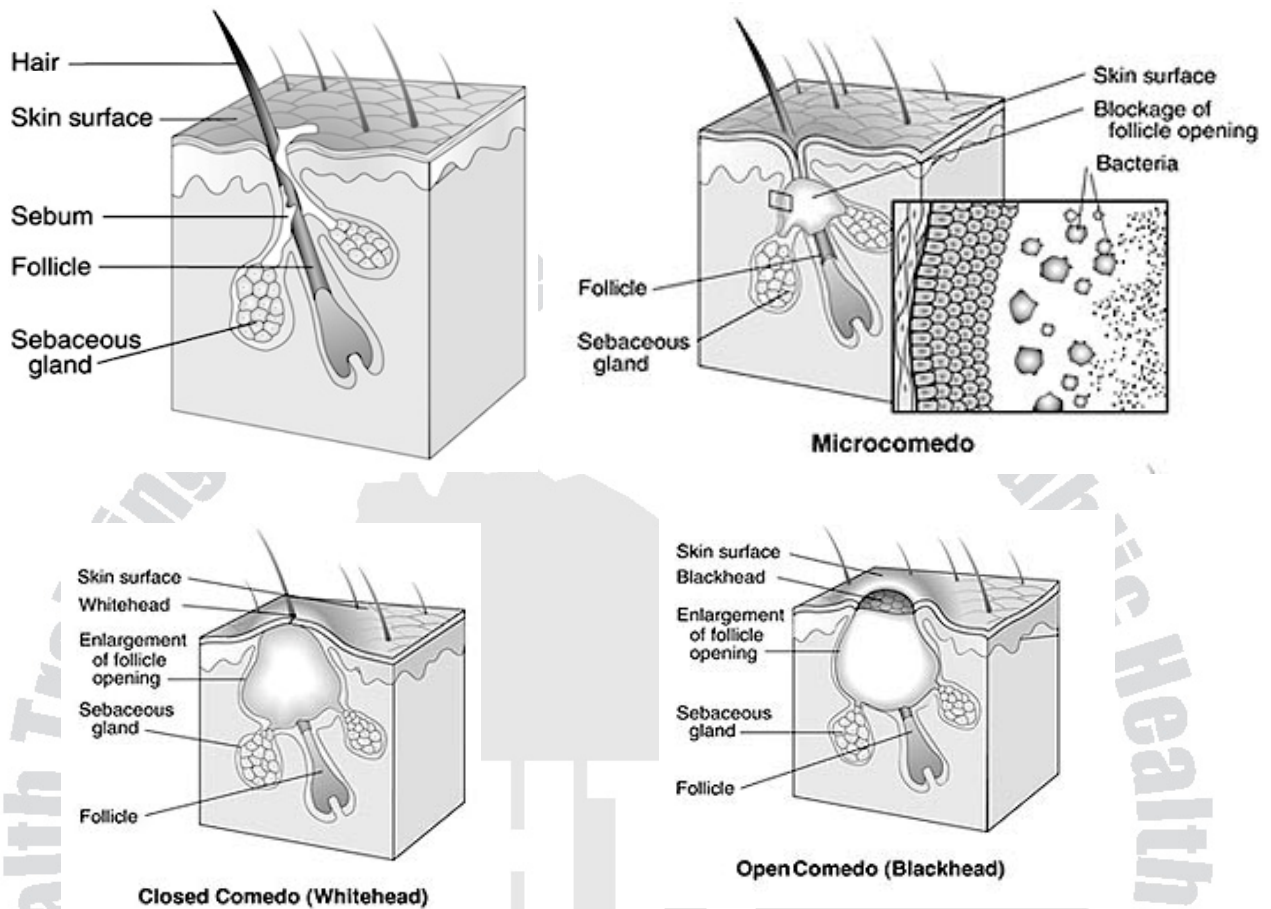

## Treatment

Treatment should be directed toward the known pathogenic factors involved in acne. These include follicular hyperproliferation, excess sebum, *P. acnes*, and inflammation. The grade and the severity of the acne help in determining, which of the following treatments, alone or in combination, is most appropriate.

### Topical treatments

Each works a little differently. Benzoyl peroxide (2.5-10%) at night is best at killing *P. acnes* and may reduce oil production. Resorcinol, salicylic acid, and sulfur help break down blackheads and whiteheads. Salicylic acid also helps cut down the shedding of cells lining the follicles of the oil glands. Topical medications are available in many forms, such as gel, lotion, cream, soap, or pad.

- Topical antibiotic; -Topical antibiotics are mainly used for their role against *P. acnes*. They may also have anti-inflammatory properties. The development of resistance is lessened if topical antibiotics are used in combination with benzoyl peroxide. Erythromycin and clindamycin alone or in combination with benzoyl peroxide.
- Topical retinoids are comedolytic and anti-inflammatory. They cause epidermal differentiation and, thus, normalize follicular hyperproliferation and hyperkeratinization. Adapalene, tazarotene, and tretinoin are in common use. they are applied once daily to clean, dry skin.

### **Systemic treatment**

Tetracycline, (minocycline, doxycycline and tetracycline, erythromycin 1g daily for one month then 250 bid for 4-6 months). Trimethoprim, alone or in combination with sulfamethoxazole, are systemic antibiotics and anti-inflammatory.

Isotretinoin is a systemic retinoid that is highly effective in the treatment of severe, recalcitrant acne vulgaris

Patients with moderate to severe inflammatory acne may be treated with prescription of topical or oral medicines, alone or in combination.

### **Advice needs to be given to the patient**

1. Chronicity of the problem
2. Not to squeeze acne lesion
3. washing with warm water but has to avoid irritants
4. Not to use cortisone cream

### **3.12. Psoriasis**

Psoriasis is a chronic inflammatory and proliferative disorder of the skin clinically manifested as well-circumscribed, erythematous papules and plaques covered with silvery scales typically located over the extensor surfaces and scalp. While specific systemic and environmental factors are known to influence the disease, it has

unpredictable course with spontaneous improvement and exacerbations of lesions. Immune system dysfunction in the background of a genetic predisposition is believed to be at the core of the disease process.

**Epidemiology** Psoriasis affects 1-2% the population in all geographic regions. The Male and female ratio is 1 to 1 and the peak age of onset is in the 20s

### **Etiology and Pathogenesis**

Despite being the subject of intensive research over the years, the precise etiology of psoriasis still remains unknown. Genetic factors can be implicated on the basis of population surveys, twin studies (65% concordant in monozygotic twins) and analysis of pedigrees. The precise mode of inheritance is uncertain, thought to be polygenic.

**Provocating factors:** A number of factors may provoke onset or aggravation of psoriasis.

**Stress** - Many patients report an increase in the psoriasis severity with psychological stress.

**Trauma** - All types of trauma can lead to the development of plaque psoriasis (eg, physical, chemical, surgical, infective, and inflammatory). The development of psoriatic lesions at a site of injury is known as the Koebner phenomenon.

**Infection** – An acute eruption of guttate psoriasis may be provoked by streptococcal pharyngitis. HIV infection may be associated with increase in disease severity.

**Drugs** - Lithium, withdrawal of systemic corticosteroids, beta-blockers, antimalarials, and NSAIDs may cause flare of the disease

**Sunlight** – although sunlight is generally considered to be beneficial for most of the patients, strong sunlight may worsen the disease in a small minority.

**Alcohol** - Alcohol is considered a risk factor for psoriasis, particularly in young to middle-aged males.

**Endocrine** – the disease state may fluctuate with hormonal changes. Psoriasis may begin during puberty. Pregnancy may improve the disease while a flare may occur during post-partum period.

### **Pathogenesis of Psoriasis**

The alterations in psoriasis includes activation of T- lymphocytes against unknown antigen → increased cytokine release → increased accumulation and activation of lymphocytes and antigen-presenting cells (APCs), neutrophils which results in increased proliferation of keratinocytes. Accelerated epidermal cell proliferation results from recruitment of a large proportion of resting cells into the proliferative cycle.

*The pathology of psoriasis* reflects the underlying immune-mediated inflammation and cellular hyperproliferation.

### **Histopathologic features**

- Hyperkeratosis with parakeratosis (presence of nucleated keratinocytes in the stratum corneum due lack of maturation of cells since rapid transit time do not permit normal maturation of cells). Reduced or absent granular layer.
- Acanthosis with elongation of rete ridges and a corresponding upward elongation of dermal papillae.
- Infiltrate: Mononuclear in dermis and polymorphs in the upper epidermis forming collections called 'microabscess of Munro'.
- Upper dermal vasculature shows dilatation and tortuosity.

**Types of presentations:** the patients may present in a variety of ways with overlapping features being not uncommon.

1. Chronic plaque psoriasis (psoriasis vulgaris). The commonest type of psoriasis, presenting with typical plaques of psoriasis of the extensors surfaces like knee, pretibial area elbows and trunk, back and scalp. The plaques stay for months to years without progression that is why it is called stable plaque.

2. Guttate psoriasis (acute eruptive psoriasis). Generally uncommon but appears in childhood and young adults. Acute eruption of drop-shaped lesions distributed widely over the body. Usually it follows streptococcal throat infection.
3. Flexural psoriasis (psoriasis inversa): lesions are present over the flexors and intertriginous areas (axilla, groin, umbilical region, inframammary folds) the lesions may be moist and lack the typical scaling.
4. Generalized pustular psoriasis may occur as an explosive eruption of generalized pustules with systemic disturbances. This may follow withdrawal of systemic steroid therapy or application of irritants
5. Pustular psoriasis. May be localized or generalized. Localized pustular psoriasis usually presents with persistent pustular eruptions of the hands and feet.
6. Erythrodermic psoriasis (more than 90% of the body surface area affected). Psoriasis may present with Erythroderma (exfoliative dermatitis). There is generalized inflammatory erythema with profuse scaling. The mortality is very high without proper care( exfoliative dermatitis and its management)
7. Arthropathic psoriasis. Arthritis may accompany any variety of psoriasis in about ten per cent of patients. Psoriatic arthritis may take several forms. The commonest type is asymmetrical oligoarthritis, other types are: symmetrical seronegative rheumatoid-like disease , distal interphalangeal involvement( most characteristic, but relatively rare), axial skeletal involvement, and a destructive mutilating form (arthritis mutilans)

**The typical lesions of psoriasis** have the following features;

The lesions are very well marginated with distinct border and are raised above the surface.

The plaques usually have a diameter of one to several centimeters and have a round or oval shape. The lesions may merge together to give rise to geographic patterns. The lesions are covered with silvery white, mica-like, loosely adherent scales which, on removal may reveal punctate bleeding points (Auspitz sign)

Symmetry: the lesions are symmetrically disposed on extensor surfaces of the body. Typical sites of affection are the elbows, knees, shin, knuckles, sacral areas and scalp.

## Management of psoriasis

Topical therapy is generally indicated when psoriasis is limited to less than 20% of the body surface.

Explain to the patient the recurrent nature of the disease.

Anthralin

Salicylic acid ointment has been traditionally used for its keratolytic effect. Either alone or in combination with coal tar or topical corticosteroids, salicylic acid (2% to 10%) helps to soften and remove psoriatic scale.

Coal tar 5-10% Ultraviolet Radiation although coal tar has been used to treat psoriasis for decades, its mechanism of action is still not well understood. Some studies have shown that coal tars inhibit DNA synthesis, thus acting as a cytostatic

Moisturizer (Vaseline, urea 10 ointment or cream) and expose to sun. Moisturizer (Emollients) help to hydrate, soften, and loosen psoriatic plaques

A strong topical steroid once or twice daily, cover with salicylic acid 2- 10 if necessary.

Urea 10% cream or ointment as an emulsifier, aqueous cream in folds. - Treat any super infection with betadine or antibiotics if necessary.

Vitamin D3 analogues: Calcitriol and Calcipotriol, act by regulating keratinocyte proliferation and maturation.

Retinoids Tazarotene, available in 0.05% and 0.1% gels, is a topical retinoid for the treatment of psoriasis; can regulate keratinocyte proliferation and maturation. Main side effect is irritation. Special precaution: women of child-bearing age.

PUVA photo chemotherapy -also known as PUVA, a photosensitizing drug methoxsalen (8-methoxypsoralen) is given orally, followed by ultraviolet A (UVA) irradiation to treat patients with more extensive disease. UVA irradiation utilizes light with wavelengths 320-400 nm. PUVA, decreases cellular proliferation by interfering with DNA synthesis, and also induces a localized immunosuppression by its action on T lymphocytes. Therapy usually is given 2-3 times per week on an outpatient basis, with maintenance treatments every 2-4 weeks until remission. Adverse effects of PUVA therapy include nausea, pruritus, and burning. Long-term complications include increased risks of photo

damage and skin cancer. PUVA has been combined with oral retinoid derivatives to decrease the cumulative dose of UVA radiation to the skin.

### **Systemic therapy**

In severe cases, retinoids, methotrexate, cyclosporine, and hydroxyurea may be used. Systemic corticosteroids are generally contraindicated, and they can exacerbate a very severe type of psoriasis called pustular psoriasis, which has a high rate of mortality

### **3.13. Exfoliative Dermatitis Erythroderma Syndrome “Skin Failure”**

The exfoliative erythroderma syndrome (EES) is a serious, at times life-threatening reaction pattern of the skin characterized by generalized and uniform redness and scaling involving practically the entire skin (>90% surface) and associated with systemic “toxicity,” generalized lymphadenopathy, and fever. In the acute and subacute phases, there is rapid onset of generalized vivid red erythema and fine branny scales; the patient feels hot and cold, shivers, and has fever. In the chronic EES, the skin thickens, and scaling continues and becomes lamellar. There is a loss of scalp and body hair, the nails become thickened and separated from the nail bed (onycholysis), and there may be hyperpigmentation or patchy loss of pigment in patients whose normal skin color is brown or black.

About 50% of the patients with EES have a history of a preexisting dermatosis, which is recognizable only in the acute or subacute stages. The most frequent preexisting skin disorders are (in order of frequency) psoriasis, eczematous dermatitis (atopic, allergic contact, seborrheic), adverse cutaneous drug reaction, lymphoma, and pityriasis rubra pilaris. Drugs most commonly implicated in erythroderma are found In 10 to 20% of patients it is not possible to identify the cause by history or histology.

### **Pathogenesis**

The metabolic response to exfoliative dermatitis may be profound. Large amounts of warm blood are present in the skin due to the dilatation of capillaries, and there is considerable heat dissipation through insensible fluid loss and by convection. Also, there may be high output cardiac failure; the loss of scales through exfoliation can be

considerable, up to 9 g/m<sup>2</sup> of body surface per day, and this may contribute to the reduction in serum albumin and the edema of the lower extremities so often noted in these patients.

### **Systemic changes associated with exfoliative dermatitis and erythroderma**

- i. Hypothermia and hyperthermia
- ii. Fluid and electrolyte disturbance
- iii. Sepsis
- iv. Pyrexia occurs due to pyrogens transcutaneously.
- v. Hypoproteinemia from exfoliation
- vi. Anemia
- vii. Vitamin deficiency states
- viii. By unknown mechanism they have they have GIT disorders such as mal absorption.

### **Possible Etiology of Exfoliative Dermatitis in Adults**

❖ Undetermined or unclassified	23%
❖ Psoriasis	23%
❖ Atopic dermatitis, eczema	16%
❖ Drug allergy	15%
❖ Lymphoma, leukemia	11%
❖ Allergic contact dermatitis	5%
❖ Seborrheic dermatitis	5%
❖ Stasis dermatitis with “id” reaction	3%
❖ Pityriasis rubra pilaris	2%
❖ Pemphigus foliaceus	1%

### **Physical examination**

Appearance of Patient frightened, red, “toxic.” *Skin is red*, thickened, and scaly. Dermatitis is uniform involving the entire body Surface except for pityriasis rubra pilaris, where EES spares sharply defined areas of normal skin. Thickening leads to



exaggerated skin folds; scaling may be fine and branny, and may be barely perceptible or large, up to 5 cm, and lamellar.

**Palms and Soles** Usually involved, with massive hyperkeratosis and deep fissures in pityriasis rubra pilaris, Sézary's syndrome, and psoriasis.

**Hair** - Thinning of hair, even alopecia, except for EES arising in eczema or psoriasis.

**Nails** - Onycholysis, shedding of nails.

*General Examination* Lymph nodes generalized, rubbery, and usually small; enlarged in Sézary's syndrome. Edema of lower legs and ankles.

### **Diagnosis**

Diagnosis is not easy, and the history of the preexisting dermatosis may be the only clue. Also, pathognomonic signs and symptoms of the preexisting dermatosis may help, e.g., dusky-red color in psoriasis and yellowish-red in pityriasis rubra pilaris; typical nail changes of psoriasis; lichenification, erosions, and excoriations in atopic dermatitis and scaly eczematous lesions starting from the scalp and seborrheic area may suggest seborrheic eczema.

### **Course and Prognosis**

Prognosis depends on underlying etiology. Despite the best attention to all details, patients may succumb to infections or, if they have cardiac problems, to cardiac failure ("high output" failure) or to the effects of the prolonged glucocorticoid therapy that may be required.

### **Management**

This is an important medical problem that should be dealt with in a modern inpatient dermatology facility with experienced personnel. The patient should be hospitalized in a single room, at least for the beginning workup and during the development of a therapeutic program. The hospital room conditions (heat and cold) should be adjusted to the patient's needs; most often these patients need a warm room with many blankets.

Topical Water baths with added bath oils, followed by application of bland emollients.

Systemic oral glucocorticoids for remission induction and for maintenance (except in psoriatic EES); systemic and topical therapy as required by underlying condition. Supportive cardiac, fluid, electrolyte, protein replacement therapy as required.

### **3.14. Common skin manifestations of HIV/AIDS**

Up to 92% of HIV/AIDS patient will have one or more skin disorders during the course their illness

The cutaneous manifestations occurring in HIV infection are mostly due to the alterations in the immune system. Presenting with atypical presentation, more disseminated disease, or being resistant to conventional therapies and patient having related disorders eg candidiasis, H. zoster – etc and the general condition of the patient wasted etc

- 1- **Seroconversion illness:** - Acute primary HIV infection may lead to a transient, generalized, morbilliform eruption on the trunk and the arms. Some 25% will have exanthema
- 2- **Skin conditions at early and intermediate stage of the disease** With the onset of immunosuppression, skin changes are nonspecific such as common disorders with atypical clinical features, including recurrent varicella zoster, numerous hyperkeratotic warts, treatment-resistant seborrhoeic dermatitis, and oral hairy leukoplakia

#### **a) Seborrhoeic dermatitis 85%**

seborrhoeic dermatitis-like eruptions are observed in 85% of patients with AIDS. It may be the initial cutaneous manifestation of HIV disease. The eruption, which is characterized by widespread inflammatory and hyperkeratotic lesions in seborrhoeic areas, may progress to erythroderma in some patients.

Seborrhoeic dermatitis may be increased in patients with AIDS-associated dementia or CNS disease.

The immune alterations caused by HIV infection may lead to psoriasis and Reiter syndrome. In some instances, pre-existing psoriasis may become more severe with disseminated plaques and pustules.

**b. Pityriasis rosea** may accompany HIV disease with extensive erythematous plaques skin lesion with history of herald patches. They can have repeated episodes of pityriasis rosea.

**c) Scabies** can be found in all forms of HIV. Classical scabies occurs commonly with HIV.

**Norwegian (crusted) Scabies Atypical scabies** which is characterized by wide spread hyperkeratotic plaque occurs on palms and soles, scaly maculopapular eruption or crusted can occur in classical sites but can also be generalized involving face and all parts of the body

**d) Xerosis (dryness of the skin) and acquired ichthyosis: 25-30%**

Generalized dry skin syndrome is frequently observed in patients with HIV infection. Xerosis may be the initial clinical manifestation of AIDS, and it is often a cause of pruritus.

Acquired ichthyosis may begin on the lower extremities and disseminate in advanced HIV disease. Acquired ichthyosis may be a marker of concomitant infection with HIV-1 and human lymphotropic virus II in persons who uses intravenous drugs and who have profound helper T – cell depletion.

**e) Herpes zoster-** with lower CD4 counts CD4 counts (300-400cell/mm<sup>3</sup>) it tends to be mutidermatomal or hemorrhagic, disseminated or even ulcerated or recurrent and it also can occur outside limited dermatome.

**f) Human papilloma virus (HPV) infection**

In patients infected with HIV, widespread or recalcitrant warts may be observed on the oral mucosa, the face, the perianal region, and the female genital tract. The perianal

and cervical lesions may be difficult to treat. Large plantar warts caused by HPV-66 and an epidermodysplasia verruciformis like eruption (numerous plane warts on sun exposed parts of the body), which is believed to be associated with HPV infection, have also been reported in patients infected with HIV.

**g) Pruritic papular eruption (PPE)**

PPE is a common cutaneous manifestation in patients infected with HIV. It manifests as small, itchy, red or skin-colored papules on the head, the neck, and the upper part of the trunk. The cause is not known. About 81.25% of patients with PPE have advanced immunosuppression.

**3-Skin conditions with advanced disease** - In the later stages of HIV disease, chronic HSV, MC, and CMV appears. Mycobacterial infections and mucocutaneous candidiasis occur.

**a) Oral pharyngeal candidiasis**

**b) Oral hairy leukoplakia** Epstein-Barr virus (EBV) has been implicated in the pathogenesis of oral hairy leukoplakia. Oral hairy leukoplakia, which is characterized by filiform white papules localized on the sides of the tongue, may develop in patients infected with HIV. Oral hairy leukoplakia has no malignant potential, but it may be the initial sign of progressive immunosuppression. White plaques may be confused with oral candidiasis, lichen planus, and geographic tongue.

**c) Eosinophilic folliculitis** manifests as an idiopathic, highly pruritic, papulopustular eruption of sterile pustules around hair follicles involving the face, the neck, the trunk, and the extremities.

**d) Herpes ulcer – chronic herpes simplex ulcer More than 1 month**

Chronic perianal and perioral herpetic ulcers caused by HSV and disseminated CMV infection. Recurrent oral and anogenital HSV is common in patients infected with HIV, and it may lead to chronic ulcerations. In pediatric patients, herpes simplex stomatitis

is more common than varicella zoster virus (VZV), and it may become chronic and ulcerative.

**e) Cytomegalovirus infection**

**f) Molluscum contagiosum (MC) in adults.**

Usually occurs in children, but with HIV it can occur in adults. Molluscum contagiosum can become confluent and giant. MC nodules can occur with HIV.

**g) Bacillary angiomatosis**, which is caused by *Bartonella henselae* and rarely by *Bartonella quintana*, is usually manifested by red papules and nodules

**Skin disorders at any stage of HIV**

**Bacterial infections**

Impetigo and folliculitis may be recurrent and persistent in HIV disease, particularly in children.

Disseminated furunculosis, gingivitis, gangrenous stomatitis, and abscess formation can occur in patients with HIV infection.

**Fungal infections**

**Superficial fungal infections**

Recurrent and persistent mucocutaneous candidiasis is common in patients with HIV infection. In the United States, recurrent vaginal candidiasis is the most common presentation of HIV infection in women.

In adults, generalized dermatophytosis, or Tinea capitis, which is typically caused by *Trichophyton rubrum*, may suggest HIV infection.

Pityriasis versicolor may be persistent, generalized and recurrent in patients with HIV infection.

## Deep fungal infections

Cutaneous Cryptococcus may be observed in patients with HIV infection, but it is rare. Clinical manifestations include cellulitis; papules; plaques; ulcers; or translucent dome-shaped papules with central umbilication, resembling MC.

Cutaneous histoplasmosis may lead to red papules, cellulites - like eruption, ulcerations, acneiform papules, or molluscum - like lesions in patients infected with HIV.

North American blastomycosis may present as a disseminated maculopapular eruption in HIV disease.

Systemic coccidioidomycosis may disseminate to the skin, usually as hemorrhagic papules or nodules

## Cutaneous drug eruptions 10%

Sulfonamides may cause urticaria; erythema multiforme; toxic epidermal necrolysis; and systemic reactions, including fever, leukopenia, thrombocytopenia, hepatitis, and nephritis. Toxic epidermal necrolysis has been reported with antibiotics, fluconazole, clindamycin, phenobarbital, and chlormezanone in patients with HIV.

Drug eruptions have been reported as the most common cause of erythroderma in patients infected with HIV.

Photosensitivity has been reported in patients with advanced HIV disease. Photo-induced lichenoid drug reactions may be seen particularly in dark-skinned patients.

**Aphthosis:** - Severe aphthous stomatitis may be associated with HIV disease. Autoimmunity, atopic disease, and urticaria

Thrombocytopenic purpura, vitiligo, alopecia areata, sicca syndrome, pemphigoid, and other autoimmune blistering diseases have been reported in association with HIV disease.

Atopic disease may be reactivated by HIV disease. Atopic eczema may be severe in children infected with HIV. Increased serum IgE levels have been found in these children. However, increased IgE levels were not correlated with atopic symptoms.

Urticaria may occur primarily or as a drug eruption in HIV disease.

Photosensitivity has been reported in patients with advanced HIV disease. Photo-induced lichenoid drug reactions may be seen particularly in dark-skinned patients.

### **Hair and nail disorders**

Diffuse alopecia or alopecia areata may be associated with HIV disease and may be inflammatory and permanent.

Generalized alopecia can occur in patients with HIV who are treated with indinavir, an antiretroviral protease inhibitor.

Elongation of the eyelashes and softening and straightening of the scalp hair may be observed in HIV disease.

Beau lines, telogen effluvium, and pallor of the nail beds are the general effects of the chronic illness.

Proximal subungual onychomycosis is usually a sign of HIV disease

### **HIV-associated malignancies**

**Kaposi sarcoma:** - KS was the first reported malignancy in association with HIV infection.

The worldwide incidence of KS in patients with AIDS may approach 34%. KS is believed to be a proliferation of endothelial cells induced by human herpesvirus type 8 (HHV-8).

KS begins as pink macules that become disseminated and palpable. Purplish or brown macules and plaques may become nodular. Mucosal involvement is common.

The clinical progression of KS in patients infected with HIV is more aggressive than the other clinical types of KS.

AIDS-related B-cell non-Hodgkin lymphomas may lead to skin nodules.

Anal carcinoma and cervical intraepithelial neoplasia (CIN) are papillomavirus-associated tumors associated with HIV disease. These tumors tend to be more progressive and aggressive.

**N.B:** Regarding Leprosy you are advised to refer the Manual prepared by disease prevention and control department, Ministry of Health, Ethiopia, 2002. Also encouraged to read modules prepared through EPHTI by member institutions for skin manifestations of Onchocerciasis and leishmaniasis.

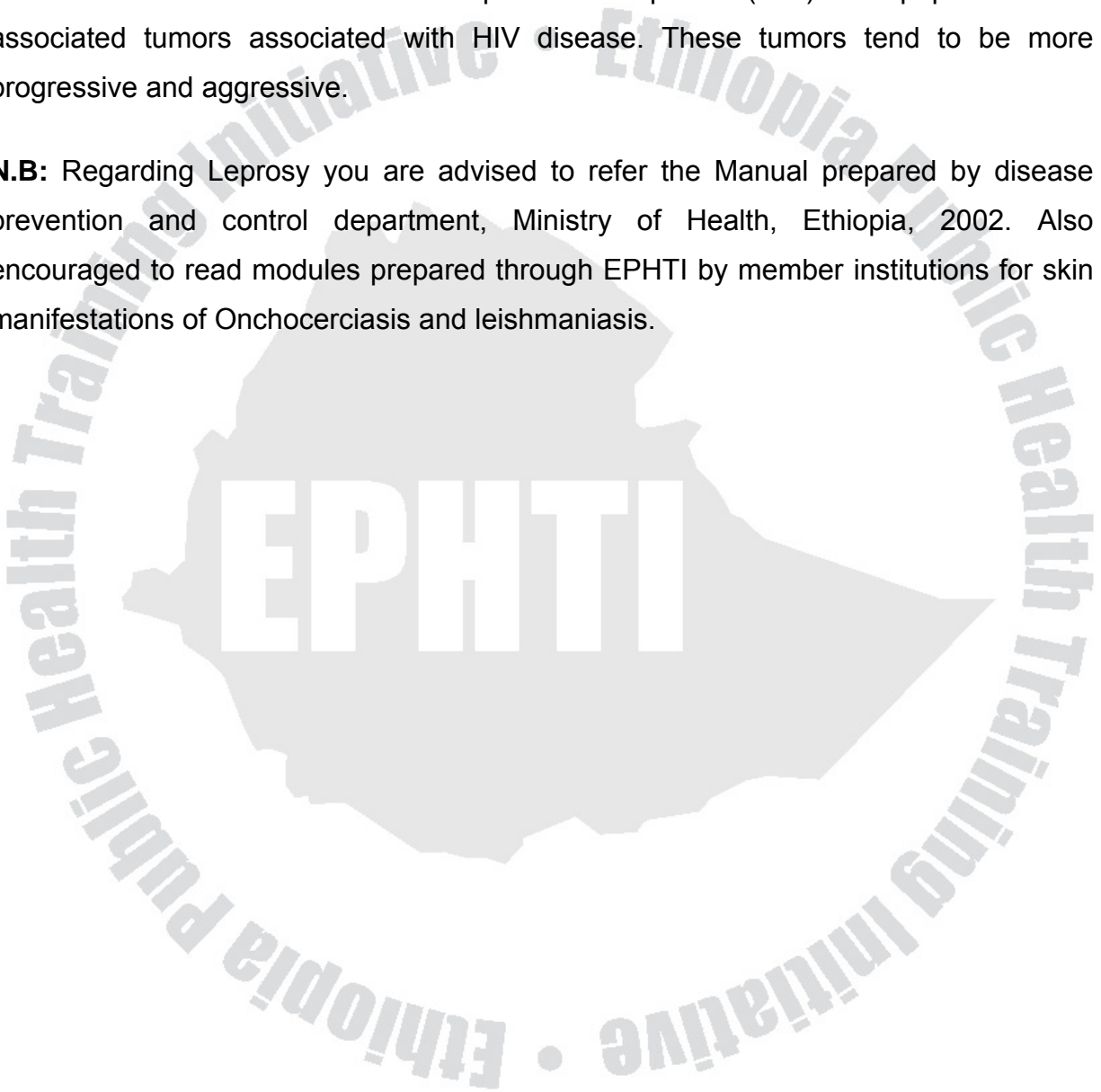



# UNIT FOUR

## SATELLITE MODULE FOR NURSES

(Diploma level)

### 4.1. Introduction

#### 4.1.1. Purpose and use of this satellite module

This module is intended to be used by midlevel Nurses and is believed to equip them with basic and adequate information that are not discussed in the core module. Besides, it helps the health worker to appreciate common skin infectious disease by focusing on bacterial, fungal, viral and parasitic skin problems including non-infectious skin disease

#### 4.1.2. Direction for using this module

Before going to this satellite module you should go through the core module which contains the basic information about common skin infection and in the mean time, through reading it, you can appreciate what other categories team members are doing.

#### 4.1.3 Pre-test for mid level nurses

1. Which one of the following is not function of skin under normal condition?
  - a) Protection
  - b) Sensation
  - c) Excretion
  - d) None of the above
2. Which part of the body will be attacked with fungal infection?
  - a) Scalp
  - b) Body
  - c) Genital areas
  - d) Foot
  - e) All

3. All are skin diseases, except
  - a) Leprosy
  - b) Acne vulgaris
  - c) Carbuncle
  - d) Edematous skin lesion
4. All are possible causes of skin diseases, except
  - a) Chemical agent
  - b) Physical agent
  - c) Irritant substances
  - d) None of the above
5. All can be practical measures to prevent skin disease except
  - a) By keeping cleanliness of the skin
  - b) By early identification
  - c) By removing the predisposing factors
  - d) By treating all skin diseases with antibiotics
6. All are pyodermal skin problems except:
  - a) Impetigo
  - b) Frunclosis
  - c) Carbuncle
  - d) Boils
  - e) Acne
7. It is the disease associated with poor personal hygiene and low living condition
  - a) Scabies
  - b) Acne
  - c) Carbuncle
  - d) Leprosy
8. Nurse can manage a disease called scabies in the health center by ordering
  - a) Benzyl benzoate lotion
  - b) White filed ointment
  - c) Procaine penicillin 600.00 unit I.M daily for 7 days
  - d) All of the above

9. Which of the following is/are a true statement about management of herpes zoster at health center?
- a) To reduce pain, give paractamol tablet according the age
  - b) Clean the lesion areas with antiseptic solution and dress the areas accordingly
  - c) Advice the patient to take rest and nutrition
  - d) All of the above
10. The most serious skin reaction that can be seen with a disease of leprosy is called
- a) Reversal reaction
  - b) Erythema nodosum leprous reaction (ENL)
  - c) Both reversal reaction & ENL
  - d) None of the above
11. All are true statements about cutaneous Leshimaniasis except,
- a) Single or multiple lesion that can be changed to ulcer
  - b) Mucocutaneous lesion will involve in nasopharyngeal tissue
  - c) Animals are consider as source of infection
  - d) All of the above
  - e) None of the above
12. The role of nurse who is working in primary health care unit, for the patient who is admitted and developed bedsore will be all, except
- a) Clean and dress the wound
  - b) Encourage the patient to take balanced diet
  - c) Maintain skin integrity
  - d) Refer the patient to nearest hospital
  - e) None of the above

## 4.2 Learning Objective

At the end of reading through this module the nurse should be able to

1. Distinguish different types of common skin diseases
2. Provide the necessary nursing care accordingly
3. Practice the various types of preventive method

## 4.3 Pyodermal bacterial skin diseases

### 4.3.1 Erysipelas

Erysipelas is skin infection caused by staphylococcal pyogens or B-hemolytic streptococcus, characterized by well-demarcated erythema and swelling on the face or extremities associated with pain and fever.

The distinctive features of erysipelas are well-defined erythema with indurated margin particularly among nasolabial fold rapid progression and intense pain flaccid bullae may develop during the second and third days of illness

#### Treatment

- Penicillin is the drug of choice which is given if the lesion becomes bullous or to higher level
- Anti pain
- General skin care- cleaning the skin and applying antiseptic cream
- Encourage personal hygiene like regular washing hands

### 4.3.2 Boil (Furuncle)

Definition – Bacterial infection of hair follicles

- A furuncle is an infection of a hair follicle and carbuncle infection of more than one hair follicle
- It often occurs as an extension a superficial folliculitis
- These infections often occur in hairy areas of the body, especially where there is perspiration and friction.

## **Cause**

Staphylococcus aureus

## **Clinical presentation**

The lesion develops into a hard, red, tender nodule which often bursts, discharging pus and frequently a solid core of necrotic tissue.

\*It is rarely accompanied by systemic symptoms, when the lesions are multiple

## **Clinical finding**

Gram stains and cultures of the drainage may be used to definitively establish the causative organism but mostly diagnosed is clinical

## **Treatment**

For simple furuncle, the primary treatment is usually the application of warm, moist packs, to help the body localize the infection and mobilize its normal phagocytic response, thereby promoting drainage of the infectious site. Topical antibiotic cream and systemic antibiotic for multiple lesions

### **4.3.3 Carbuncle**

#### **Definition**

A carbuncle is a deeper infection involving several follicles, often forming a collection of pus or abscess. It is painful usually associated with fever. The common site includes neck, thighs, and back.

#### **Cause**

Like furuncles the causative organism is generally a staphylococcus aureus/streptococcus

#### **Clinical presentation**

The involved area of the skin is usually red, indurate, and painful with multiple pustules and several draining points with purulent drainage. The lesion often develops a yellow gray crust at the center, which is permanent and readily visible scar.

- It is frequently associated with fever; pain and malaises & white blood count sometimes reveals leukocytosis.

**Treatment:** systemic antibiotic, drainage of abscess, local skin care and dressing.

### **Predisposing factors**

- Diabetes mellitus
- Immune suppress (HIV long term steroid treatment)
- Poor hygiene and warm climate

### **Treatment**

Systemic antibiotic, drainage of abscess, local skin care and dressing

### **Complication**

- Manipulation of furuncles on the face may cause sinus thrombosis and total pyemia.
- Other possible complications of manipulated furuncles are
  - Perinephric abscess
  - Osteomyelitis
  - Endocarditis
- Bacteremia and other secondary infections can occur.

### **Nursing management of furuncle & carbuncle (treatment)**

- Control fever and pain
- Teach patient to take adequate fluid, food and rest to enhance the healing process
- Monitor the affected local area & the development of systemic progression
- Apply warm and moist packs
- Teach patient to avoid any manipulation to the infected area
- Teach patient about prescribed medications
- Treat with systemic antibiotics

#### **4.3.4 Impetigo:**

Impetigo is a superficial bacterial infection of the skin caused by

- Streptococci
- Staphylococci or
- Multiple bacteria

The lesions begin as small red macular (spot), which quickly become discrete thin walled vesicles that soon rupture and become covered with loose adherent honey yellow crust. The crusts are easily removed and reveal smooth, red moist surfaces on which new crusts soon develop.

**Common sites:** The exposed area of the body such as, face, hands, neck and extremities are the most frequently involved.

Note: impetigo is known to be contagious and may spread to other parts of patient's skin or to other members of the family who touch the patient or use towels that are soiled with the exudates of the lesions

- Although impetigo is seen at all levels of ages, it is particularly common among children living in poor hygienic conditions it also appears secondary to pediculus capitis, scabies, herpes simplex, insect bites and eczema etc.

### **Common signs and symptoms**

- Small lesions which are vesicular or bullous
- Red macules followed by thin adherent honey – yellow crust
- Crust are easily removed
- Itching and oozing when vesicle is ruptured

### **Diagnosis and clinical finding**

- History
- Physical exam (detecting of lesion)
- Culture gram stain
- Sites of involved

### **Nursing care**

- Nursing assessment
- Examine and determine the types of lesion
- Consider the site of involvement
- Rule out underlying skin conditions
- Clean the skin

- Apply topical antiseptic cream or antibiotics
- Treat with systemic antibiotic
- Advise on personal hygiene
- Relief pain by using non steroidal anti inflammatory drugs (NSAIDS)
- Systematic antibiotic therapy
- Clean the wound with antiseptic preparation to reduce bacterial content
- Wash lesions with water or soak soap solution
- After crusts are removed, topical medication will be used eg neomycin or tetracycline or mupirocin is applied,
- Glove should be given when care is given to the patient

### **Preventive measure**

-Patient education and home care

-The patient and family should be instructed to bath at least once daily with bactericidal soap cleanliness and good hygienic practices help to prevent the spread of the lesions from one skin area to another and from one person to another

-Each person should have separate towel because impetigo is contagious until totally cure.

### **Complications**

- Spread of infection, cellulites, erythema
- Glomerulo – nephritis (Systematic reaction to streptococcal antigens)
- Scarring formation in deeper lesion
- Disfiguring and loss of asthetic appearance (Post inflammatory hypo or hyper pigmented of skin)

#### **4.3.5 Cellulites:**

Is bacterial infection that spreads in to the subcutaneous tissue. Involves deeper structure of skin and Characterized by erythema, edema of affected area (there will be swelling of the extremities) some times blisterma and ulceration. Streptococcus bacteria are frequently the responsible organisms. The manifestation of inflammatory process is evident.



**Management:** - systemic antibiotic are usually effective. Rest` will decrease muscular contraction, which would force offending organism in to the circulatory system

- Elevate affected limbs to reduce edema
- Clean the skin apply antiseptic cream and antibiotics
- Remove necrotic and dead tissue from the surface of the lesion

#### **4.3.6 Leprosy (Hansen's disease)**

Is a chronic mycobacterial infectious disease caused by myco bacterium leprae that affect the skin and peripheral nerves? It causes nerve damage (nerve function loss) characterized by muscle weakness and hypo pigmented macula. In advanced cases papules, nodules and inflammation

#### **What is a leprosy reaction?**

A leprosy reaction is manifested with inflammation of the skin lesion and peripheral nerves. It occurs due to the immune system in the body attacking the leprosy bacilli. The inflammation in the skin lesions causes redness and edema, therefore the hypopigmented macular lesion become red and raised. It causes discomfort and pain or may ulcerated in sever cases. If this not treated early the inflammation in the peripheral nerves causes tenderness/pain/ and enlargement of the nerves, which may lead nerve damage with motor or sensory loss (muscle paralysis and loss of sensation of extremities) the nerve damage, account, for the disability and stigma in leprosy.

#### **When do reactions occur?**

A person with leprosy can have a reaction at almost any time. Before treatment, during treatment and after treatment has been completed.

#### **Classification of leprosy**

For the choice of multi drug therapy bacillary (MDT) patients are classified as Paucibacillary (PB) and Multi bacillary (MB). So, new patient will be classified based on the numbers of skin lesions and result of skin smear.

You need one of the three to diagnose leprosy. If you are in doubt wait and recheck after few months

## Chemotherapy of leprosy

PB				
	Drugs	Dose	Duration of RX	Method of use
	DDS	100 mg	6months	Self administer
	Rifampicin	600 mg	6months	Under supervision
MB				
	DDS	100 mg	1year	Self administer
	Clofazemin	50 mg	1year	Self administer
	Rifampicin	600 mg	1year	Under supervision
	Clofazamin	300 mg	1year	Under supervision

### Paucibacillary

Patient with one to five leprosy skin lesions

### Multi bacillary

- Patient with six or more skin lesions
- Patient with less than six skin lesions and have positive skin smear result

### How to examine for leprosy reaction of skin

- Ask the person if there is any pain and swelling on the skin patches, the nerves have to be examined for swelling of nerves and tenderness
- Exam the patient for signs of inflammation on skin
- Examine the hands and feet for signs of loss of sweating loss of sensation of palm and sole, ulcer and weakness of muscles

### When to diagnose Leprosy

- Hypopigmented macular lesion with loss of sensation.
- Enlarged, tender peripheral nerve with loss of sensation.
- Puncture skin smear for M/leprae

### How to diagnosis leprosy

Leprosy lesion can be patch or nodules

Diagnosis is based on the cardinal signs of leprosy. At least one of the following cardinal sign must be presnt

1. Anesthetic patch (hypo pigmented patch with loss of sensation)

2. Nerve enlargement and/or tenderness
3. AFB in slit skin smears examination (positive acid fast bacilli in slit skin smear examination)

If in doubt give an appointment for 3-6 months

### **The two types of leprosy reaction**

1. Type I or reversal reaction
2. Type II or erythema nodosum Leprosum (ENL)

### **Who is likely to get a type I of reaction (reversal reaction)**

Type 1 reaction is caused by increased activity of the body's immune system in fighting the leprosy bacilli. It occurs in people who have strong cell-mediated immunity. Both paucibacillary and multibacillary get type 1 reaction and commonly seen within six months of starting treatment, but some of patients may show this reaction before starting treatment even before leprosy has been diagnosed.

### **What are the clinical features of type I reaction**

The most common clinical feature is inflammation in the skin patches with swelling, redness and warmth. The patches are not usually painful, but there may be some discomfort associated with swelling of the limbs or face may occur. The peripheral nerves become enlarged and tender. The nerve damage in type 1 reaction is usually severe. And cause disability and deformity.

### **Type II reactions (Erythema Nodosum Leprosum)**

Occur in a patient with high bacillary load. When large numbers of leprosy bacilli are killed and gradually decompose. Proteins from the dead bacilli provoke humoral allergic reaction. Since these proteins/antigens are present in the blood stream, the reaction will involve the whole body causing generalized symptoms. Nerve damage in type II reaction is usually mild.

### Who is likely to get a type II reaction?

Only multibacilli patient with positive slit skin smear get type 2 reactions

### When do type II reactions occur

The reactions occur most commonly during leprosy treatment and since it takes long time to clear the dead bacilli and remains for years after stopping the treatment.

### What are the clinical features of type II reaction?

Type II reaction exhibits the typical sign of erythema nodosum, these are subcutaneous nodules which are painful as a result of inflammation. It can be few or many in number and occur on the face, trunk, and extremities. The lesions appear in groups and subside spontaneously while new crops reappear. The peripheral nerves may be enlarged with or without functional loss.

### Management and Nursing intervention

1. Identify the types of reaction
2. If both types of reaction are mild treat with acetyl-salicylic acid (ASA) or aspirin, adult dose is 600 mg up to six times per day with Anti acid or after meal
3. For severe reaction corticosteroids prednisolone is most commonly used.

### For PB patient standard dose of prednisolone

<u>Week of course</u>	<u>Daily dose of prednisolone</u>
1- 2	40 mg
3- 4	30 mg
5- 6	20 mg
7- 8	15 mg
9-10	15 mg
11- 12	5 mg

❖ Total duration is twelve weeks

### For MB patient the standard treatment

<u>Week of course</u>	<u>Daily dose of treatment</u>
1- 4	40 mg
5- 8	30 mg
9-12	20 mg
13-16	15 mg
17- 20	10 mg
20-24	5 mg

❖ This course last 24 weeks

### Nursing intervention

- ◆ Rest is important during episode of reaction or inflammatory condition
- ◆ Splint can be applied to the limb to rest affected Muscle & nerves
- ◆ As recovery begins the nurse has to do passive exercise to help the range of movement and follow by active exercise to restore muscle strength
- ◆ Give health education to the patient about the medication and reducing the risk of damage to body parts
- ◆ If patient has loss of sensation in their feet, advise to wear proper footwear, with microcella rubber inside the shoes
- ◆ If the patient has wound, you should keep clean by using water and soap and cover them with clean dressing and advice rest
- ◆ Oil such as vegetable oil or Vaseline should be applied to keep the skin in good condition and smooth
- ◆ Make sure the patient is getting the ordered medication properly.
- ◆ Avoid discrimination and stigmatization
- ◆ Give health education on the disease condition to the family including community

### 4.3.7 Psoriasis

#### Definition

Psoriasis is a chronic noninfectious inflammatory disease of the skin in which the production of epidermal cells occurs at a rate that is approximately 6 -9 times faster

than normal rate. Increased proliferation of epidermal cells induced by abnormal reaction of immune system.

In this condition the normal events to cell maturation and growth can not take place.

This abnormal process does not allow formation of the normal protective layers of the skin.

The onset may occur at any age but is most common between the ages of 10 and 40 years, but may occur at any age.

It has a tendency to improve and then recur periodically through out life.

Cell proliferation is mediated by the immune system.

### **Cause**

The exact cause of psoriasis is not well determined. However, there appears to be a hereditary defect that causes over production of epidermal cell. A combination of specific genetic make-up and environmental stimuli may trigger the onset of the disease.

### **Aggravating factors/ triggering factor**

- ◆ Emotional stress
- ◆ Anxiety
- ◆ Trauma
- ◆ Infections
- ◆ Seasonal and hormonal changes
- ◆ Cigarette smoking
- ◆ Alcohol consumption and drugs
- ◆ Non steroidal anti-inflammatory drugs.

### **Clinical manifestation**

- Lesions appear as dark red, raised plaque lesion covered with silvery scales
- Lesions produce multiple bleeding points when the scales are scraped away
- These patches are not moist and mostly is not itchy
- When psoriasis occurs on the palms and soles, it can cause pustular lesions
- Lesions can be symmetrical

## Particular sites of the body tend to be affected

- Scalp
- The area over the elbows and knees, lower part of the back & genitalia
- The extensor surfaces of the arms and legs,
- Over the sacrum and the inter gluteal fold

If nails are involved, it may be presented by

- Pitting
- Discoloration
- Crumbling beneath the free edge and
- Separation of the nail plates

## Complications

- Arthritis (the relation is not understood)
- Erythrodermic psoriasis (involving the whole body surface)

## Treatment

Goal: To reduce the rapid turnover of the epidermis and to promote resolution of the psoriatic lesions

- Advise that the disease may persist for life with remission and exacerbation.
- Control the problem:
  - Remove precipitating or aggravating factors
  - Reduce stress
  - Teach patient that treatment of severe psoriasis can be time consuming

## Treatment topical systemic

1. **Topical** – slows down the over active epidermis: i.e act by suppressing the epidermal turnover epidermopoiesis

Eg. Tar preparations, salicylic acid, and corticosteroids.

2. **Systemic therapy**

- Systemic cytotoxic preparations such as methotrexate, have been used in treating extensive psoriasis that fails to respond to other forms of therapy in specialized center

## **Nursing management**

- Teach patient to avoid picking or scratching the psoriatic area
- Teach patient to avoid any topical irritant or allergy- producing Substance
- Teach patient to report to physician for any infection that appears to aggravate the psoriasis
- Caution patient about medication because some drugs may worsen psoriasis.
- Patients need a balanced life, including recreation, exercise & rest
- Prevent drying of the skin
  - Avoid frequent washing
  - Water should not be too hot,
  - Avoid vigorous rubbing by towel after bath
  - Use skin emollients
- Help patient move toward self-acceptance
- Advice to be exposed to the sun

### **4.3.8 Acne Vulgaris**

Acne vulgaris is an inflammatory disorder of sebaceous unit. It is a common inflammatory disorder affecting face, chest and back but it may occur at any site.

Acne is the most commonly encountered skin condition, affecting an estimated 85% of the population between 12 & 35 years of age. Girls develop acne 2years earlier than boys

#### **Characteristics**

Characterized by the presence of – closed comedones (white heads,)

Open comedones (black heads) are primary lesions while Papules, Pustules, and Nodules & cysts are secondary lesions

- Becomes more marked at puberty
- Occurs when the pilosebaceous duct is plugged



## Clinical manifestations

Closed comedones (white head) –

Are formed from impacted lipids or oils and keratin that  
plug the dilated follicle

- are small, whitish papules
- may evolve in to open comedones
- have minute follicular openings that can't be seen

-Open comedones(Black head)

– contents are in open communication with the external  
environment the blackhead is due to accumulation of lipid,  
bacterial & epithelial debris that obstruct the flow of sebum.

Factors which contributes to the development of the acne lesion are:

- 1.Excess secretion of sebum
- 2.Obstruction of the pilosebaceous orifice
- 3.Inflammation as a result of *Propionibacterium acnes* and leakage of

content of pilosebaceous content

N.B Intradermal rupture of sebaceous gland induces an inflammatory reaction due to the leakage of follicle contents (Sebum, keratin, bacteria) in to the dermis.

This inflammatory response may result from the action of certain skin bacteria, such as *Propionibacterium acnes*, that live in the hair follicles and break down the triglycerides of the sebum into free fatty acids and glycerin. The resulting inflammation produces papules, pustules, nodules, cysts or abscesses.

## Management

- The disease is age limited, worse around puberty and subsides in early twenties. It is controlled with treatment.
- Combination of therapies should be used are available to control acne effectively
- Topical treatments may be all that is needed to treat mild to moderate acne.
- In severe cases antibiotics such as tetracycline are used to treat the problem

## **Surgical Rx.**

- Consists of comedo extraction needed for cystic lesion, injections of steroids into the inflamed lesion, and incision and drainage of large, fluctuant, nodular cystic lesions.

## **Nursing management**

- Inform patient that acne arises because of combination of factors
- Instruct patient to wash the face with mild soap and water twice a day to remove surface oils and prevent obstruction of the oil glands
- Caution the patient to avoid scrubbing the face constantly
- Hair should be kept off the face and shampooed daily if necessary
- Inform patient that all forms of friction and trauma should be avoided
- Teach patient that squeezing merely worsens the problem, this may be cause of post inflammatory hyperpigmentation
- Teach patient to be consistent with treatment because the problem is chronic
- Advise patient that cosmetics, shaving creams, and lotions can agitate acne
- Reassurance and emotional support, reduction of stress

### **4.3.9 Decubitus ulcer (bedsores, pressure sore) associated with infection**

Bedsore is a special type of ulcer caused by impaired blood supply and tissue nutrition resulting from prolonged pressure over bony or cartilaginous prominences. The skin overlying the sacrum and hips is most commonly involved, but bed sores may also be seen over the occiput areas, elbow, heels, ankles, scapula, medial condyle of tibia and head of fibula. They may occur most readily in aged, paralyzed, debilitated and unconscious patient.

### **Factors contributing for bed sores**

Immobility, decreased sensory perception, decreased tissue perfusion and nutritional status, friction, increased moisture of the skin

Poor nourishment, and obesity (patient have large amount of poorly vascularized adipose tissue)

## **Clinical manifestation**

If a pressure area is noted, the nurse notes its size and location and use grading system to describe its severity.

### **Stage I**

Pressure ulcer is an area of Erythema, tissue swelling and congestion and with patient complaining discomfort, the skin temperature is elevated because increase vasodilatation. The redness progresses to a dusky, cyanotic blue gray appearance, which is the result of skin capillary occlusion weakening of subcutaneous tissue.

### **Stage II**

Pressure ulcer exhibits a break in the skin through the epidermis include the dermis, and also necrosis of the skin will occur.

### **Stage III**

Pressure ulcer extend to sub cutaneous tissue

### **Stage IV**

Ulcer extend in to the under lying structure including muscle possibly the bone. The skin lesion may represent only the tip of ice berg” between small surface ulcer may overlie a large under lining area.

The appearance of pus or foul odor is suggestive sign of infection

## **Nursing diagnosis**

Impaired skin integrity related to any of the contributing factors.

## **Nursing goal**

The major goals of nursing may include relief of pressure; improve mobility, improved nutritional status and tissue perfusion.

## **Nursing interventions**

1. Relieving pressure – frequent change of position by using variety of pads & supportive device to prominent area or if it is possible use flotation or water bed.
2. Improve mobility – patient is encouraged to remain active, passive and active exercise help to increase muscular skin and vascular tone.

3. Improve sensory perception- by increased awareness of self
4. Improve tissue perfusion- exercise and repositioning will improve tissue perfusion
5. Improve nutritional status- high protein and iron will be given to increase the level of hemoglobin
6. Reduce friction - Make the bed daily & as needed to give comfort
7. Minimizing moisture- soiled skin should be washed with mild soap and water and then dry with soft towels and if the patient is in continent urine catheterization will be done
8. Maintain skin integrity by offering bath
9. Teach the family about frequent position and the important of skin hygiene.
10. Give the prescribed antibiotic
11. Dress the wound accordingly

#### **4.4 Eczema**

Eczema is a recurrent inflammatory disorder of the skin precipitated by persistent itching followed by erythematous, edematous vesicular and oozing lesion. Eczema could be sub acute or chronic. In acute stage erythema (redness), papules, vesicles, scales, crusts, or scabs appear alone or together. In chronic stage thickening of the skin, hyper pigmentation and lichinification due to longterm scratching.

Eczema is not a specific disease. It is characterized by a vicious cycle of inflammation – itch – scratch.

→ Dermatitis and eczema are terms that may be used interchangeably to describe a group of disorders with a characteristic appearance.

#### **Classification of eczema**

Eczemas are basically classified into endogenous and exogenous factors.

#### **Endogenous factors constitutional**

- Atopic
- Seborrhoic

#### **Exogenous factors:**

- Contact dermatitis ( irritant and allergic contact)

- Photo dermatitis (Phototoxic and photo allergic)

Unclassified (special group)

- Neurodermatitis
- Juvenile plantar dermatitis

**Clinical Features Common to Most Patterns Of Eczema ( different stage of eczema)**

### **1. Acute eczema**

Is characterized by:

- Redness and swelling, usually with an ill-defined border
- Papule, vesicles, and large blisters
- Exudation and crusting
- Oozing
- It can be itchy, but not always

### **2. Sub acute dermatitis**

**Characterized by:**

- Moist lesion, erythematous, excoriated, scaling papules
- Plaques that are either grouped or scattered over erythematous skin

### **3. Chronic eczema**

- More likely to be lichenified (a dry leathery thickened state, with increased skin markings, secondary to repeated scratching or rubbing)
- More likely to develop painful fissures

### **Complications**

1. Heavy bacterial colonization is common in all types of eczema (but overt infection is most trouble some in the seborrhoeic and atopic types).
2. Reaction to medications may provoke dissemination, especially in stasis eczema.
3. Anxiety states may develop with all severe forms of eczema
4. Herpes infection of the eczematous is serious complication
5. Scarring and permanent hyperpigmentation.

## Differential diagnosis

- Psoriasis
- Fungal infections
- Scabies etc.

## Treatments

### A. For acute weeping eczema

- Application (soaking with) potassium permanganate or saline solution followed by
- Application of smear of corticosteroid cream or lotion
- Application of non-sticky dressing or cotton gloves when hands & feet are involved
- For wider areas: - systemic corticosteroid and lotion
- frequent application of calamine lotion
- Systemic antihistamine.
- Rest
- Control secondary infection with systemic antibiotics.

### B. For sub acute eczema

- Steroid
- Antibiotic creams like neomycin
- Antibiotic will be given if it is infected

### C. For chronic eczema

- Steroids in ointment base with keratolytic such as salicylic acid
- Systemic antibiotics for bacterial super infection
- Sedative antihistamines, eg. Trimeprazine or hydrolyzine may be prescribed for severe itching

## Nursing management

- It is important to distinguish between exogenous and endogenous eczema
- Identification and removal of source of irritation/offending material
- Explain, reassure and encourage patient
- Apply occlusive bandaging to interrupt scratch /itch cycle

- Teach patient – to keep his finger nails short
  - to avoid scratching
  - reduce anxiety/stress
- Inspect the affected area for infection
- Prevent drying of the skin by using emollients (oil) like Vaseline and liquid paraffin
- Rest, nutritious food
- Compliance to prescribed medication
- Apply wet dressing

The purpose of wet dressing:-

1. To reduce inflammation by reducing constriction of blood vessels
2. Cleanse the skin of exudates, crusts and scales
3. Maintain drainage of infected area

Wet dressing is used for vesicular, bullous, pustular and ulcerative conditions. The dressing solutions generally consist of room temperature of tap-water or saline and other agent including silver nitrate, aluminum acetate, potassium permanganate 5% acetic acid with sodium hypochlorite.

Although some dressing must be covered to prevent evaporation, most are allowed to remain open. The open dressing requires frequent changes because evaporation is rapid.

Wet dressing should be reapplied every 5 minutes to ensure their wetness It should be applied for 15-minute period three to four times daily, during the acute phase.

Medication applied to moist skin immediately after treatment with compresses is absorbed better than dry skin

## **Brief points about contact dermatitis**

Dermatitis is an inflammatory reaction of skin to physical chemical or biological agents. The epidermis is damaged by repeated physical and chemical irritations

Contact dermatitis may be of primary irritant type in which non-allergic reactions resulted from exposure to irritant substances or it may be allergic in nature (allergic contact dermatitis) resulting from exposure of sensitized persons to contact allergens

## **Causes of contact Dermatitis**

- Soap
- Detergents
- Industrial
- Chemicals
- Extreme cold and heat
- Pre – existing skin diseases

Ideally contact dermatitis is confirmed using patch test

## **Management**

The objectives of the management are to rest the involved skin and to prevent further exposure of the patient to the causative agents.

**NB.** No amount of treatment can control the disease if the patient continues to come in contact with the agent, whereas if further exposures to the agent are prevented, the patient tends to recover even without any treatment.

It is important to encourage the patient to wash the skin area with soap and water, to wash off the remnants of the antigens, which may still be lying on the skin. Treatment of dermatitis consists of local compresses with saline or potassium permanganate twice daily followed by local application of a corticosteroid ointment. In severe cases and secondary bacterial infection antibiotic may be necessary. If the itching is very severe oral antihistamine tablets may be given twice or three times a day and in very severe and generalized case a short course of systematic corticosteroid may be helpful in providing quick relief.



- As a rule, a dose of corticosteroids equal to 30 mg of prednisolone a day is sufficient and once the disease has been controlled, this can be quickly with decreased over the next two weeks

**N.B** normally, not advice to use systemic corticosteroid, if topical steroids doesn't help, you can refer the person to higher-level health facility

**Note:** Corticosteroid have got anti-inflammatory and anti allergic effect.

#### **4.4.1 Atopic Dermatitis**

Atopic dermatitis: is an inflammatory disorder of the skin but in this case the patient inherits an increased tendency of becoming sensitized to various environmental allergens.

This tendency is inherited as a polygenic recessive character and several relatives of the patient also often suffer from one of the atopic disorder which include asthma, urticaria and allergic dermatitis

Atopic dermatitis is an intensely pruritic, recurrent inflammation of the skin occurring in all groups (infant, childhood and adolescent). It is the most common type of infantile eczema and is also seen in characteristic patterns in children, adolescents and adults too.

Approximately 70 percent of patients with atopic dermatitis have a family history of atopy. About 3 percent of infants have some evidence of atopic dermatitis during the first few months of life and many children with atopic dermatitis develop either rhinitis or asthma at a later age.

#### **Clinical manifestations**

Many of the clinical signs and symptoms seen are secondary to scratching and rubbing of the skin

- The clinical manifestations of atopic dermatitis during infancy are called infantile atopic eczema and consists of severely itching, erythematous, papulo-vesicular lesions which appear on the cheeks and spread to other parts of the body
- In severe cases exudations and massive crusting can occur

**Note:** Atopic dermatitis usually sets up a vicious cycle, itching leads to scratching and scratching causes oozing and other changes. Infantile atopic eczema usually starts on the face, cheek and extensor of extremities and can even be generalized, including flexures and trunks in the first six months, later in childhood, adolescent and adult hood also affect the flexures and the trunk.

#### **Atopic dermatitis age base description**

- In the infantile phase of atopic dermatitis, age 2 months to two years, there is the involvement of primarily the cheeks, face, scalp, neck, extensor extremities with erythematous papulo-vesicles and oozing.
- In the childhood phase, between the ages of 4 and 10 years, the lesions are less acute and exudative, more scattered red and often localized in the flexor folds of the neck, elbows, wrist and knees. Dry papules, excoriations lichenifications, erythema and edema are common.
- In the adolescence and adult phase the lesion occurs on flexures of extremities the lesions are primarily dry lichenified, hyperpigmented plaques in flexor areas and around the eyes, Persistent hand dermatitis may be the only remnants of atopic dermatitis. Generally adults with atopic eczema will have dry skin.

***Treatment refer to contact dermatitis***

#### **4.4.2 Superficial fungal Infections**

The fungi are tiny representatives of the plant kingdom that feed on organic matter. They are responsible for a variety of common skin infections, in some cases, they affect only the skin and its appendages (i.e. hair & nails).

Superficial fungal infection rarely cause temporary disability & respond readily to treatment. Secondary infection with bacteria or Candida or both may occur.

The most common fungal skin disease is known as tinea or ringworm.

There are various types of ring worm or tinea and they are named according to the site of involvement as:

- Tinea infections affect the feet commonly called athlete's foot or tinea pedis
- Fungal infection of head- tinea capitis.
- Fungal infection of the body including face, neck & extremities -tinea corporis.
- Fungal infection of groin -Jock itch, or tinea cruris
- Fungal infection of the nail -tinea unguium.

#### **4.4.3 Tinea pedis (Ringworm of the feet: Athlete's foot)**

Fungal infection of foot is one of the common fungal infections and it may appear as an acute or chronic infection to the soles of the feet or the space between the toes and some times a mixture of fungal, bacterial and yeast infections occur. There are dry scaly types of lesion. Others are vesicular type of lesion the third group is macerated lesion between toes, especially between the third, fourth and, fifth toes.

##### **a) Mode of transmission**

Contact with an infected person i.e. sharing patient shoes and socks, or in showers or swimming pools

##### **b) Clinical manifestation**

In acute stage there will be red weeping vesicles that can be accompanied with itching and burning sensation.

The nail may also be involved with chronic infection

Lymphangitis & cellulitis may be seen when bacterial super infections occurs.

##### **c) Management and Nursing intervention**

- During the acute (vesicular) phase, soaks of burrow solution, salin or potassium permanganate are used to remove the crusts, scales and debris and reduce the inflammation.

- Topical antifungal (Miconazole, clotrimazole) applied to the infected area. Topical therapy is continued for at least 8 weeks, because of recurrence.
- Keep the foot clean and dry daily and tell the patient to use clean socks
- Moisture encourages the growth of fungi, the pt is instructed to keep the feet as dry as possible
- Pieces of cotton can be placed between the toes at night to absorb moisture.
- Clean shoes daily or boil soaks.
- Remove dead tissue and dry well between the toes.
- Advise the patient to wear light and open foot wear
- Apply dusting powder such as zinc oxide powders for the purpose of drying.

#### **4.4.4 Tinea corporis (Ring worm of the body)**

They are known to cause an intense inflammatory reaction in humans because they are not normally adapted to living on human hosts.

##### **a) Mode of transmission**

Through contact with patient or through contact with object, the patient has used that.

##### **b) Clinical manifestation**

Typical annular ringed lesion is produced with an advancing scaly border and central clearing or scaly patches with well defined margin. It are associated with purities.

##### **c) Management and Nursing intervention**

- Topical antifungal medication may be applied to small areas of lesion
- Griseofulvin is used in extensive cases but has side effect include photo sensitivity, skin rashes, headache & nausea.
- In those patient who have resistance to griseofulvin, ketoconazole, an antifungal agent shows real promise in patient with chronic fungal (dermatophyte) infection,

- Give education to use clean towel & washcloth daily.
- All area and skin folds that retain moist must be dried thoroughly; fungal infections are fostered by heat & moisture. The patient has to wear clean cotton cloth next to the skin.

#### **4.4.5 Tinea capitis (Ringworm of the scalp)**

Ringworm of the scalp is a contagious fungal infection of the hair shafts and common cause of hair loss in children.

##### **a) Mode of transmission**

Making contact with an infected person such as use of hat, comb and brush of diseased person.

##### **b) Clinical manifestation**

- Clinically, one or several round patches of redness and scaling are present on scalp
- Small pustules or papules may be seen at the edges of such patches.
- As the hair in the affected areas are invaded by the fungi, the fungi become brittle and often break off at or near the surface of the scalp, resulting in patchy loss of hair. Most cases of tinea capitis heal without scarring, so the hair loss is temporary.
- It could be complicated by secondary bacterial infection

##### **c) Management and nursing intervention**

1. Griseofulvin and other anti fungal agents are administered systemically according to the prescription. Advice to take griseofulvin after meal since it is lipid soluble antifungal
2. The hair should be shampooed two or three times weekly with antifungal shampoo.
3. Topical antifungal preparation should be applied preferably white field ointment.
  - Patient and family should be advised to set up a hygienic regimen for home use

- Family member should have a separate comb & brush
- All infected members of the family & household must be examined and treated.

#### **4.4.6 Tinea cruris (jock itch)**

Tinea cruris is a ringworm infection of the groin, which may extend to the inner thighs and buttock area. It most frequently occurs in young, obese persons and those who wear tight underclothing and is commonly associated with tinea pedis.

##### **a) Clinical manifestation**

- Itching may be severe, or the rash may be asymptomatic
- The lesion consists of erythematous plaque with well-defined margins & a cleared center
- Rarely the lesion may have a vesicle formation at the borders and satellite vesicle lesions are rarely present. It could be complicated by secondary candidal infection.

##### **Management**

###### **General measure**

- Drying powder eg. Miconazole nitrate should be dusted in to the involved area in a patient with perspiration or occlusion of skin due to obesity. Underwear should be loose – fitting
- Advice to wear light cotton underwear.
- Iron or boil underwear and change daily.

###### **Local Fungistatic measure (topical treatment)**

- Clean affected area daily and keep it dry.
- Topical medication such as clotrimazole, ketoconazole, miconazole cream will be used for 3 to 4 weeks
- Terbenatin cream is curative in over 80% of cases twice daily for 7 days
- Systemic treatment griseofulvin (ultramicro size) reserved for severe cases, 10-15 mg/Kg daily for 1-2 weeks

#### **4.4.7 Tinea unguium (onycho- mycosis)**

Tinea unguium (fungal infection of the nails) is a chronic fungal infection of the nails and is most common on toe nails and less frequently toe nails.

##### **a) Causative organism**

The disease is caused by trichophyton species, Trichophyton rubrum and candida albicans.

##### **b) Clinical manifestation**

Tinea unguium of toe nails is usually associated with long standing fungal infection of the feet.

- Nails thicken, crumble easily mostly starting of distal end of nail, and lack luster and the nail color changes to brown and the whole nail may be destroyed usually started at the distal end of the nail.

##### **c) Management and nursing intervention**

1. Griseofulvin is usually prescribed orally 10-15 Mg/Kg twice daily from 6 months to years ( until normal nail grows fully)
2. If the causative organism is candidal infection the patient will be treated with topical lotion or cream like amphotericin – B lotion, miconazole, clotrimazole, and nystatin
3. Give daily nail care

#### **4.4.8 Tinea versicolor (pityriasis versicolor)**

It is a mild, superficial infection of the skin, usually of the trunk.

##### **a) Causative organism**

The disease is caused by yeast, pityrosporum orbiculare which is a normal flora of skin, (pityrosporum orbiculare) and which accounts for the high recurrence rate after treatment and initial cure

##### **b) Clinical finding (sign and symptoms)**

- ↳ Lesion are asymptomatic, but a few patients note mild itching
- ↳ The lesions are various types color hypo pigmented or with, whitish or brown scales macules on surface that vary 4-5 mm in diameter

- ↪ The lesions initially do not look scaly, but powdery scales may be readily obtained by scraping the area
- ↪ Lesion may appear on the trunk, upper arms, neck, face and groin

### **c) Management and nursing intervention**

- Topical treatment like selenium sulfide or clotrimazole shampoo which may be applied from neck to waist daily and left on for 5 -15 minutes for 7 days. This treatment is repeated weekly for a month and monthly for maintenance.
- Ketoconazole shampoo may also be used weekly
- 3% salicylic acid in rubbing alcohol and sodium thiosulfate is also used to remove scaly substance from skin
- To prevent relapse sulfur – salicylic acid soap or shampoo or zinc pyrithrone containing shampoo used on a continuing basis may be effective prophylaxis
- Ketoconazole 200 mg daily orally for one week or 400 mg as single oral dose, apparently results in short term cure of 90% cases
- Advise the patient to take daily baths
- Iron under wears and T-shirts

## **4.4.9 Candidiasis**

### **a) Epidemiology**

Candidiasis is a fungal infection caused by *Candida albicans*. This organism is frequently a normal inhabitant of mouth, throat, large intestine and vagina. It propagates in areas that are moist and warm, such as in mucous membranes and folds of tissues. Oral candidiasis is commonly encountered among denture wearers in the debilitated, diabet and patient with anemia. The disease will occur also in those patient under going chemotherapy, local radiation treatment and patients who are using corticosteroid and anti biotic. Candidiasis is often one of the manifestations of HIV/AIDS.

### **b) Mode of transmission**

Oral candidiasis occurs spontaneously in the mouth from normal flora due to prolonged use of antibiotic or immunosuppressive thrapy or HIV infection..



### **c) Clinical manifestation of oral candidiasis (oral thrush)**

Oral candidiasis is manifested by the appearance of adherent white plaque on tongue and inner surface of cheek. In advanced disease esophageal involvement is the most frequent type of invasive mucosal disease. The lesion is found around oral and pharyngeal mucosa, particularly on the mouth and tongue, if scraped raw bleeding area seen. The lesions are usually painless, but fissuring at the corner of the mouth can be painful. The lesions can characteristically be scraped off.

### **Candidal vulvovaginitis**

Present as an irritable erythema associated with a copious white curdy discharge. Pregnant and diabetic women are at risk.

### **Management of candidal vulvovaginitis**

1. Fluconazole or itraconazole can be given. Short course enough for immune competent
2. Clotrimazole vaginal tablet 100mg tab per vagina for 3 to 6 days
3. Miconazole vaginal also can be used for 3 days
4. Ketoconazole 200 mg can be used for one week

### **d) Diagnosis and lab Finding**

Diagnosis is made clinically and/or, by microscopic examination of scraping from the affected area and by endoscopy with biopsy and culture.

### **e) Management of oral candidiasis and nursing intervention**

Therapy depends upon the severity of disease, if a patient is able to swallow and take adequate amounts of fluid orally:

- Fluconazole 100 mg/d for 10-14 days, if the patient is more ill or has developed esophagitis while taking fluconazole.
- Relapse is common when there is underlying HIV infection.
- Mouth care will be given frequently
- Ketoconazole 200-400 mg with break fast for 7-14 days
- Clotrimazole 10 Mg dissolved orally five times daily

- 0.12% chlorhexidine or half – strength hydrogen peroxide mouth rinses may provide local relief
- Nystatin powder (100,000 units /g) applies to dentures three or four times daily for several weeks may help denture wears.
- Tell the patient to take mouth care always after meal
- Also Nystatin suspension swish and swallow BID or prn

## **4.5 Viral Infection**

### **4.5.1 Varicella (Chicken Pox)**

Chicken pox is a highly contagious disease of child hood or adult that has never had chicken pox caused by human herpes virus, which can be caused either by Herpes virus varicella

#### **Mode of transmission**

The disease will be transmitted through inhalation of infective droplet nuclei

#### **Incubation period**

Contact with lesions after 10-20 days.

#### **Clinical manifestation**

- Fever and malaise are usually mild in children and more severe in adult
- The pururitic rash is centripetal and most prominent on the face, scalp and trunk and lesser extent on the extremities
- Maculopapule change in few hours to vesicle that become pustule & eventually form crust. New lesion may erupt for 1-5 days. The crusts usually slough in 7- 14 days, rash appears as drops on a rose petal
- Vesicular lesion, quickly rupturing to form small ulcers and appear first in oropharynx

#### **Complication**

Secondary bacterial infection particularly with group A beta hemolytic streptococci is common and encephalitis rarely.

The complications are:-

Cellulites, osteomyelitis, epiglottis's and pneumonia are more common in adult than in children. But in children acute respiratory disease syndrome is the common complication

### **Nursing intervention**

- Maintain skin integrity by giving skin care
- Isolate the patient until the crust disappears
- Advise the patient to get bed rest until the patient is afebrile
- Keep the skin clean
- Give antibiotic for patients who have secondary bacterial infection
- Reduce fever by using analgesics like paracetamol and use tepid sponge for children according the severity of fever
- Teach the family and other community members about the disease condition
- Encourage the patient to take high fluid and maintain his/her nutritional status.

If the patient case not improvement and the condition become serious refer to the next health institution.

### **4.5.2 Herpes zoster (Shingles)**

Is an inflammatory viral condition that is caused by varicella zoster virus

#### **Epidemiology**

Herpes zoster (HZ) is more prevalent in people who are immuno compromised i.e those with Post-organ transplant patient those receiving chemotherapy or radiation therapy for malignancies or patient with AIDS. Hz is not always associated with HIV/AIDS, elderly people can get and some times people without immuno suppression can get it.

Herpes zoster represents as a reactivation of latent varicella (chicken pox) and may reflect a lower immunity. It is believed that the viruses responsible for the out break lies dormant inside nerve cells in the sensory ganglion of the spinal cord. Later, when the latent viruses are reactivated they travel by way of the peripheral nerves to the skin.

## **Clinical manifestation**

The eruption is generally preceded by pain, which may radiate over the entire region supplied by the nerves. The pain may be burning, lancinating (sharply cutting) stabbing or aching. In some patients the pain is absent and in some patients itching and tenderness may occur over the area.

The lesions are grouped vesicles appear on the red and swollen skin following a dermatome. The early vesicles contain serum and later, rupture and form crusts. The inflammation is usually unilateral, involving the thoracic, cervical and cranial nerves.

The blisters are usually confined to narrow region of the face or trunk. The clinical course varies from 1 to 3 weeks. If an ophthalmic branch of trigeminal nerve is involved the patient may have painful eye. Inflammation and rash on the trunk may cause pain at the slightest touch. In eye it causes keratitis, uveitis, ulceration and blindness. The healing time varies between 7 and 26 days Herpes zoster in healthy adult is usually localized and benign, however, in immuno suppressed patient, the disease may be severe and the clinical course acutely disabling.

## **Management and Nursing intervention**

The goal of treatment is to relieve the pain and reduce complication. These include infection, scarring post herpetic neuralgia & eye complications.

1. The pain is controlled with analgesics and may require neurontin (gabapatin) for pain control
2. Systemic corticosteroids given to patient over age of 50 to reduce the incidence and duration of complication. Healing is usually more rapid in those who have been treated with steroids.
3. started early antiviral drug such as systemic Acyclovir is effective in reducing the pain and halting the progress of the disease and assess the discomfort and response to medication on patient( try to get the patient in 24 to 48 hours)
4. Apply wet dressing or medication to the lesion.  
Wet dressing (Compresses) is usually used for acute, weeping inflammatory lesion. This may be either sterile or non sterile.
5. Systemic antibiotic to control secondary infection.

### 4.5.3 Warts

Warts (verrucae) are caused by human papilloma virus (HPV) and may be found anywhere on the skin.

#### **Causative agent**

Over 40 different subtypes of human papillomaviruses (HPV) have been identified by serological type of viral proteins

#### **Incubation period**

Average 2-18 months

#### **Mode of transmission**

- Genital warts are transmitted sexually
- Common warts are transmitted by contact with scratch and traumatized area of warts
- Genital warts may be transmitted to the newborn through passage of birth canal.

#### **Clinical manifestation**

- Usually there is no symptom but lesions are usually multiple, raised hyperkeratotic lesion on exposed areas. Plane warts occur mostly on face and lesion is slightly raised plaque.
- Warts vary widely in shape, size and appearance
- Itching occurs with anogenital warts
- Occasionally a wart produce mechanical obstruction (e.g nostril, ear canal, urethra)
- Flat warts are most evident under illumination
- Subungual warts may be dry, fissured may resemble hangnails
- Warts are usually not painful, but warts on the soles of the feet (plantar warts) often painful and resemble plantar corns.
- Cervical warts increase the risk of cervical cancer

## Management and Nursing intervention

Warts are usually self-limiting

Treatment is aimed as long as possible without scarring, since no treatment can guarantee or prevent recurrence. In immune-compromised patients the goal is probably even more modest, ie to control the size and number of lesions present.

### A- Removal of wart

1. Cry therapy like liquid nitrogen – applied for 5-10 seconds every 2-4 weeks – scarring will occur if it is used incorrectly, or too aggressively. Improper use along the side of the fingers has been reported to cause nerve damage. The treatment also causes permanent depigmentation in darkly pigmented individual
2. Keratolytic agent  
Warts may be treated by applying a 40% salicylic acid plaster. The plaster may be left on, for 5-6 days, for weeks or months, to eradicate the wart; the method is safe and effective with almost no side effects
3. 25% podophyllum resin in compound tincture of benzene or alcohol applied weekly on anogenital wart, the treatment is not used for pregnant mothers
4. Operative removal, plantar warts may be removed by blunt dissection. Electrocautery may be used for excision of warts, however, this may result in a permanent painful scar on the foot
5. Other agents – bleomycin diluted to 0.1% with 0.9% saline may be injected under warts, not exceeding 0.1 ml per puncture. It is useful for plantar and common warts
  - a. Retinoids Tretinoin (Retin – A) cream or gel applied topically twice daily may be effective for facial or beard area warts
  - b. Physical modalities soaking warts in hot (42.2<sup>0</sup>c) water for 10-30 minutes daily, for 6 weeks.

### 4.5.4 Herpes Simplex

Herpes simplex is a viral infectious disease of humans. Herpes simplex is caused by herpes viruses, which are clinically indistinguishable, known as herpes virus type 1 and

herpes virus type 2. Herpes virus type 1 is mainly responsible for herpes labialis while type 2 is usually associated with genital herpes.

### **Epidemiology**

Over 85% of adults have serological evidence of herpes simplex type 1 infection. Most often acquired asymptomatic in childhood. Occasional primary infection may manifest as severe gingivostomatitis in small children. Herpes simplex may have recurrent infection and self-limited attacks, by precipitated fevers, a viral infection, fatigue, menstruation and others triggering factors such as the sun and wind.

Genital herpes (type 2) is considered a sexually transmitted infection. It is a major concern to health care providers and consumers because of the increasing prevalence of the disease, which is 400,000 to 500,000 new cases each year and it also can recur.

### **Herpes simplex type 2 (Herpes genitals)**

It is a viral infection that causes vesicles and bullous lesion on the cervix, vagina and external genitalia: Herpes simplex virus (HSV-2) appears to be causative virus in over 80% of genital and perineal lesions and about 20% are HSV-1. Usually the virus is killed at room temperature by drying.

### **Mode of transmission**

The disease will transmit sexually and asexually from a wet surface or by self-inoculation (i.e. touching a cold sore and then touching the genital area). Generally close human contact with secretions of the oropharynx mucosal surface, vagina and cervix seems necessary to acquire the infection of herpes simplex.

### **Clinical manifestation**

- Itching which accompanies red and edematous lesion.
- Typical lesion is grouped papules and vesicles which later ulcerates and encrusts in females, the labia is the usual the primary site and possibly the

cervix, vagina and perianal skin where as in males, glans penis, foreskin and penile shaft are the affected site.

- Mild symptoms like fever, muscle ache will occur 3 to 4 days after appearance of lesion.
- Inguinal lymphadenopathy, high fever malaise, headache, myalgia and dysuria are noted
- In female, a purulent discharge may develop from a secondary bacterial infection
- Pain is evident during the first week and then decreases
- The lesion disappears in about 2 weeks unless they become secondarily infected
- Other part of the body such as the buttocks, or upper thighs and even the eyes can be involved.

### **Complication**

Severe psychological stress related to the diagnosis of the disease.

Aseptic meningitis and other complication also include pyoderma, esophagitis, transplacental fetal infection, and keratitis.

### **Management**

There is no curative treatment, so the aim of treatment is to reduce pain and to make patient comfort and decrease potential health risk.

1. Acyclovir is effective ally through the period of viral shedding. Pain, crusting and other symptoms can be shortened and healing can be hastened and also the treatment is effective in treating recurrence. Dose 200mg orally five times daily, or 400 mg three times daily or 500 mg twice daily for 10 days
2. Acyclovir ointment can be applied on the area of lesion Treatment does not cure the patient or prevent transmission of disease.



## **Nursing intervention**

- To relieve pain, lesions have to be kept clean and proper hygienic practice is advocated.
- Small ice packs may be applied to the lesion area to relieve pain
- Clothing should be clean, loose, soft and absorbent
- Tepid sitz bath are comforting & cleansing
- Bed rest to reduce pain & malaise
- Adequate fluid intake is encouraged
- Assess the fluid intake and, bladder distention
- Drug side effect has to be checked like insomnia, rash, headache, sore throat, muscle cramps and lymphadenopathy.
- Indwelling urinary catheter will be used in severe cases of dysuria
- To control infection, administer the prescribed antibiotics
- Patient education should be emphasized on physical & psychological problem of the patient

## **4.5.5 Arthropod associated Skin Disease**

### **4.5.5.1 Scabies**

Scabies is common infestation of the skin caused by, the mite called *Sarcoptes scabiei*.

#### **Epidemiology**

Scabies can occur in all economic strata of society in poor persons living under substandard and unhygienic conditions, and those living in institutions including prisoners and soldiers and those with compromised or immature immune systems but can occur in any person.

#### **Mode of transmission**

Scabies is contagious & spread from person to person by direct physical contact, including sexual contact.

## **Incubation period**

Several days or even weeks (two to four weeks) after exposure to an infected person., the adult female burrows into the superficial layer of the skin and remains there for the rest of her life laying eggs daily for up to 2 months and then dies. The eggs hatch in 3 to 4 days and progress through and form adult mites in about 10 days.

## **Clinical manifestation**

The main symptoms of scabies is itching during the night

Classic signs of scabies are the following:-

- The patient complains of severe itching caused by immunologic reaction to the mite or allergic reaction to the waste products produced by mite which burrows in the epidermis.
- Because of penetration of mite, there is a visible papule or vesicle. The classical sites are prominent between finger webs, flexure surface of wrist, elbow, anterior axillary fold, belt line, inner surface of thigh, gluteal fold penis or scrotum. In women the nipples, abdomen and lower portion of buttocks are affected. The lesion is excoriated & crusted and bacterial super infection may result from constant excoriation.
- The lesion is itchy as a result secondary bacterial infection can occur and there is cretching & excoriation marks.

## **Management and nursing intervention**

1. Instruct patient instruct to take warm, soapy baths or shower to remove the scaling debris from the crust, and dry thoroughly and allow skin to cool applying scabicide 1 % gamma hexachloride cream or lotion immediately after bathing prior drying & cooling of the skin, increases per cutaneous absorption of scabicide has the potential for CNS side effects such as seizures.
2. Benzyl benzoate lotion 25% apply for 3 consecutive days , no washing in between
3. Sulfur ointment 5% - 10% can be used for 7 days
4. 1% gamma benzene, hexacholrde single application enough but not available in Ethiopia.

5. 5% of permetherin cream single applications enough but advised to repeat treatment after week. Topical application must be applied from neck to toe. The patient should wear clean clothing & sleep between freshly laundered bed linens and all bedding and clothing should be washed in very hot water or ironed.
6. After treatment is completed ointments such as emollients like parfine or Vaseline should be applied to skin lesion, because scabicide may be irritating the skin.

**N.B.** Itching may remain a troublesome problem for a few weeks due to the occurrence of hypersensitivity particularly in the atopic (allergic) person but it is not a sign of treatment failure.

- The patient is instructed not to apply more scabicide because it will cause more irritation and increased itching and not to take frequent hot shower because it dries skin and produces itching.
- All family members and close contact should be treated simultaneously to eliminate the mite.

#### **4.5.5.2 Leishmaniasis**

Is infection by a species of the genus leishmania. The disease is classified as:

- 1) Cutaneous leishmaniasis
- 2) Visceral leishmaniasis (Kala-azar disease)
- 3) Mucocutaneous leishmaniasis (espundia)

#### **Epidemiology**

The disease occurs in large areas of Asia, Latin America, and Africa. It is transmitted by bite of Sand fly and cause a variety of illness is from skin sores to involvement of different internal organs, and as a result it may lead to death.

#### **Cutaneous and mucocutaneous leishmaniasis**

Cutaneous leishmaniasis

Caused by protozoan which has three varieties

- a) Leishmania ethiopia
- b) Leshmania brasiliensis
- c) Leshmania mexicana
- d) Leshmania aethiopia

But mucocutaneous leishmaniasis is caused by leishmania viannia, a group of organisms called leishviabraziliensis found in central & South America.

**a) Reservoir** – Animal (rats, wild rodent domestic animals like dog, cat) and infected human

**b) Incubation period** – from a day to months

**c) Clinical picture**

The first lesion starts with a papule; it can grow to nodules or it can be ulcerated and can be covered with crust.

Lesions are small papules that develop into non-ulcerated dry plaques or large encrusted ulcers with well-demarcated raised and indurated margins.

- The lesion may be single, multiple or diffuse; may be self-limiting or can be chronic
- If it is mucocutaneous the lesion appears as single or multiple papules. The lesion first is nodular and then becomes ulcerated and wart-like that can be painful. Some times the lesion appears as single nodule but later on can be indurated and involve nasal mucosa and skin and lead to destructions.
- In case of diffuse cutaneous leishmaniasis which is caused by L-Mexicana and L. aethiopia, the multiple nodular lesion is a non-ulcerating lesion, and occurs on the entire body
- Involvement of lesion in naso-pharyngeal tissue, is severely disfiguring and often fatal

Mucocutaneous leishmaniasis causes extensive destruction of the soft tissue & cartilage of the nose, oral cavity and lip and extends to the larynx & pharynx.

#### **d) Management and nursing intervention**

No effective treatment exists but the following can be used

1. Administer Sodium antimony gluconate IV or IM in a single daily dose 10 mg/kg for adult.
2. For incomplete response and relapse case give 20 mg / kg for 40 to 60 days, but electro- cardio -graphic monitoring is important during prolonged use, because the drug will cause cardiac problems
3. As alternative Oral allpurinol 20 to 30 /kg /day in three divided doses is effective
4. Treat secondary infection.
5. For resistance cases, amphotericin 0.5 to 1 mg/kg on alternative days or pentamidine 3 – 4 mg/kg three times/ week for 5 to 25 wks
6. Properly cleaning the wound.
7. Electro cautry or cryotherapy using liquid nitrogen lesion can be freezed .

**NB:** Additional Activities expected to be carried out by BSc nurses additionally are: Assessing, Diagnosing, Planning, Prioritizing, Implementing, and evaluation of patients care progress.

#### **Summary of care**

##### **A. General nursing assessment for a patient with skin impairment**

- Potential for pressure sore due to poor skin care
- Assess individual nutritional status, circulatory status, degree of mobility, whether able to self-care or not able to exercise, and mental alertness are assessed.
- Inspect skin at frequent intervals
- Areas subjected to weight bearing and friction should be given special attention
- Vulnerable areas, sacral region, buttocks, ischal tubersity, spinal processes, scapular areas, occipital areas, ears, elbows, knees and heels should be checked since they are prone to bed sores
- Assess for skin abnormality indicators such as lesion, pruritus, urticaria,.pain, redness, scaling, itching and scratching.
- Check for bacterial infection
- Check for scaring that may lead to stress psychologically.

**B. Nursing intervention to maintain skin integrity or to treat skin impairment:**

- Encourage cleanliness of the skin regularly
- Apply topical ointment when necessary
- Provide regular skin bathing
- Promote patient ambulation as early as possible if admitted patient
- Have a patient change position frequently
- Teach people to inspect their skin regularly
- Assess the risk factor for skin problems
- Maintain hygiene and cleanliness
- Prevent mechanical, physical and chemical injury to the skin
- Avoid any irritants to the skin
- Ensure adequate nutrition and hydration
- Educate or teach individuals, family and those who give skin care.
- Avoid friction with/on the skin.
- Remove the irritant factor.
- Re-assure the family and patient.

**C. Evaluation:** After carrying out nursing activities under intervention, try to re-asses the condition of skin whether it is improved or not so that you can redesign your plan of treatment.

# UNIT FIVE

## SATELLITE MODULE FOR LABORATORY PERSONNEL

(Diploma level)

### 5.1. Introduction

#### 5.1.1. Purpose and use of the Satellite Module

The medical laboratory personnel should know his or her tasks and roles as a member of the health centre team, with a particular emphasis on laboratory investigation of skin infections.

#### 5.1.2. Directions for using this satellite module

- ❖ Before reading this satellite module be sure that you have completed the pre-test and studied the core module.
- ❖ Continue reading this satellite module, and when you go through the satellite module test your self by the pre-test again.

#### 5.1.3. Pretest for Laboratory personnel

1. What are the main laboratory methods that assist for the diagnosis of fungal skin infections?
2. What are the main laboratory tests that assist for the diagnosis of Cutaneous leishmaniasis?
3. What is the reason for heating skin scraping samples after the addition of KOH?
4. Serological tests for cutaneous leishmania diagnosis are not recommended:  
A. False                      B. True
5. What is the diagnostic stage of cutaneous leishmaniasis?  
A. Promastigotes  
B. Amastigotes  
C. A & B                      D. None

6. Amastigote stages of cutaneous leishmaniasis are found inside macrophages only
- A. True                      B. False
7. Finding of characteristic hyphae & spores in KOH preparation is the basis for the diagnosis of fungal skin infection
- A. True                      B. False
8. To examine skin specimen microscopically, the one which is not important is:
- A. Evenly spread of the specimen on slide  
B. Air drying  
C. Staining the smear with Gram technique  
D. None
9. Which one of the following is true about the bacterial gram reaction of skin specimens?
- A. Gram negative rods that could be *P.aeruginosa*  
B. Gram positive Streptococci that could be *S.aureus*  
C. Gram negative coccobacilli that could be *Y.pestis*  
D. A and C
10. Which culture media are not used for isolating skin disease bacteria?
- A. Blood agar                      B. MacConkey agar  
C. Modified tinsdale medium      D. Muller Hinton Agar  
E. C and D
11. To transport skin specimens to a microbiology laboratory, one of the following is not useful.
- A. Slide                      C. Request                      E. None  
B. Labeling                      D. Transport medium
12. During Ziehl-Neelsen technique of staining *M.laprae*, the advantage of heating the stain is used for \_\_\_\_\_.
- A. Lysing the organism                      C. penetrate the lipid part of the cell wall  
B. Facilitating the staining                      D. B and C



13. The reagent that is not used for gram staining
- A. Crystal violet
  - B. Lugol's iodine
  - C. Acetone
  - D. Carbol-fuchsin
14. Identify the cells from the following, which have a pale red color after gram staining
- A. Epithelial cells
  - B. Yeast cells
  - C. Red blood cells
  - D. A and B
15. The media, which are used for transporting viruses, can also be used for bacteria.
- A. True
  - B. False
16. List some of the direct and rapid techniques used for the diagnosis of viruses.

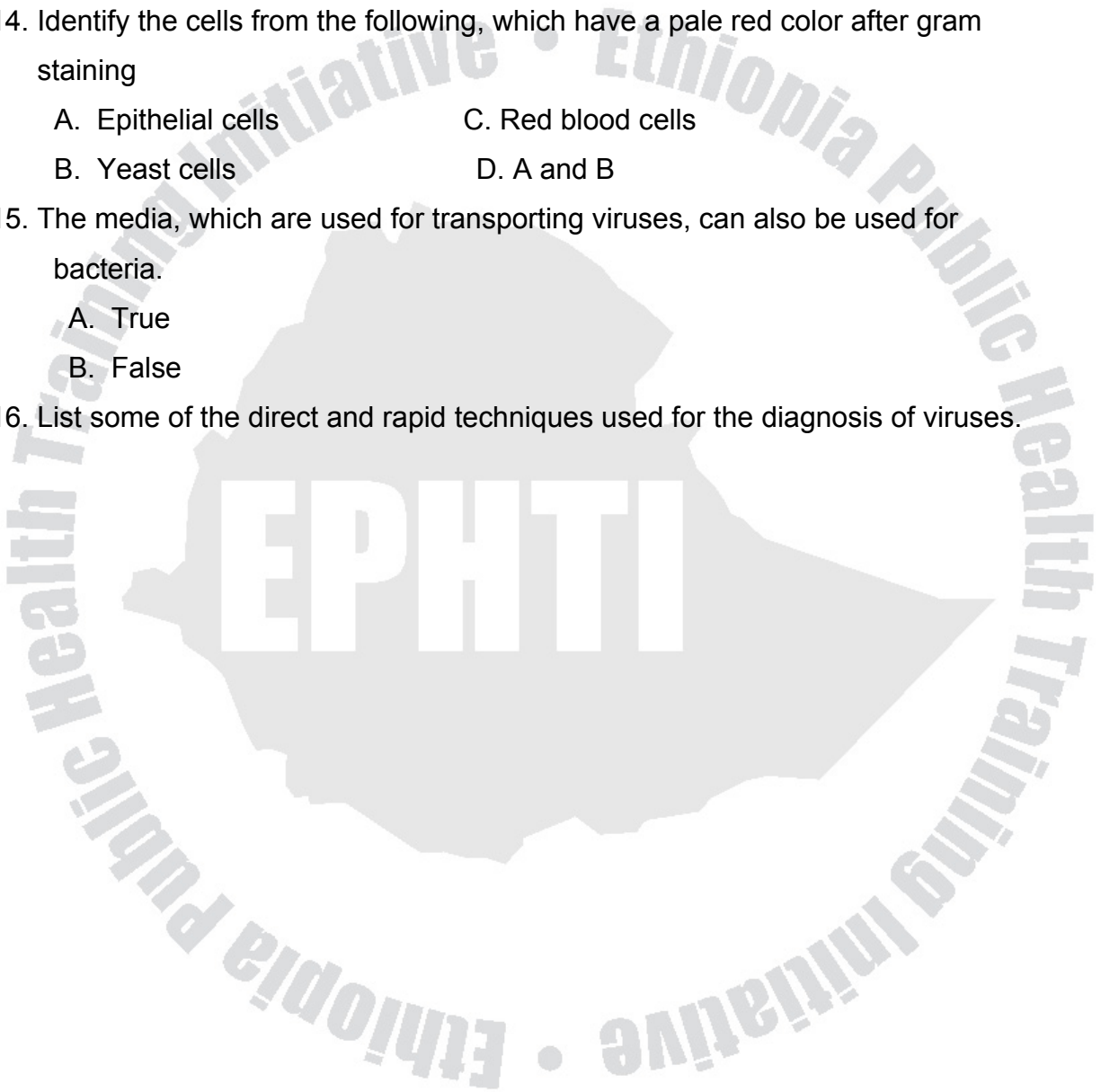

## 5.2. Learning objectives

After completion of this module the lab personnel will be able to:

- Describe how to collect, handle & label specimens from the skin
- Describe routine concepts of laboratory diagnosis of skin diseases
- Describe and demonstrate the laboratory procedures for *M.leprae* identification using Ziehl-Neelsen technique
- Describe & demonstrate how to prepare gram stain for identification of bacterial gram reaction.
- Mention the main essential laboratory diagnostic methods for diagnosis of cutaneous leishmaniasis and skin fungal infections
- Describe the microscopic appearance of the diagnostic stages of *Leishmania* and fungal structures
- Mention the techniques which are used for the diagnosis of virus in skin disease

## 5.3. Skin infection

Viruses, bacteria, fungi, or parasites can cause skin disease. The most common bacterial skin pathogens are *Staphylococcus aureus* and group A- $\beta$  hemolytic streptococci. Herpes simplex is the most common viral skin disease. Of the dermatophytic fungi, *Trichophyton rubrum* is the most prevalent cause of skin infections.

Clinical examination and staining and/or culturing of a specimen of pus or exudates are often adequate for bacterial diagnosis.

Microscopic examination of a KOH preparation of skin scales, nail scrapings, or loose hair is useful for fungal infection. Ultraviolet light (Wood's lamp) is helpful in the diagnosis of erythrasma, and some fungal infections. Other advanced diagnostic tools include culture and serological testes. For parasite skin infections a skin slit smear stained with Giemsa stain is used for the diagnosis of Cutaneous Leishmaniasis.

For viral infections, stained smears of vesicle fluid are examined under the microscope or typical cytopathology.

## 5.4. Methods for Laboratory Diagnosis of Bacteria

#### 5.4.1. Specimen collection and Examination of Bacteria:

- Specimens are collected with a blade or by swabbing the involved areas of the skin using a sterile dry cotton wool.
- If the tissue is deeply ulcerated, or if pustules and blisters are present, aspirate a specimen using a sterile needle & syringe.
- The purulent discharges or exudates are spread as thinly as possible on a glass slide for Gram staining.
- After collecting the specimen with the swab, insert the swab in to a sterile tube for culturing.
- For actinomycetes, pus is collected from closed lesions by aspiration with a sterile needle and syringe. Material is collected from draining sinuses by holding a sterile test tube at the edge of the lesion & allowing the pus & granules to run in to tube. Granules are aggregates of inflammatory cells, debris, proteinaceous material & delicate branching filaments. Pus & other exudates are examined for the presence of granules.

##### a. Examine the specimen microscopically

###### Gram smear

1. Make an evenly spread smear of the specimen on a slide
  2. Allow the smear to air-dry in safe place
  3. Stain the smear with the gram technique
  4. Examine the smear for pus cells and bacteria. Mostly skin infection causing bacteria can be differentiated by their Gram reaction due to difference in their cell wall structure.
- Gram positive Cocci that could be *S. aureus*
  - Gram positive streptococci pyogens or pneumonia
  - Gram negative rods that could be *P.aeruginosa*, proteus species, *E.coli*, or other Coliforms
  - Gram variable rods lying in chains that could be *B.anthraxis*.
  - Gram-negative coccobacilli that could be *Y. pestis*.

##### b. Examine the specimen using culture

Blood agar and MacConkey agar cultures are used for isolation of bacteria, which cause common skin diseases.

- Look for colonies like
  - o *Staphylococcus aureus*
  - o *Streptococcus pyogenes*
  - o *Pseudomonas aeruginosa*
  - o *Enterococci*
  - o *Proteus species*
  - o *Escherichia coli*
- Modified Tinsdale medium culture could be used if cutaneous diphtheria is suspected
- Use room temperature for Blood agar and MacConkey agar if *Yersina pestis* is suspected.

### **Culture the specimen**

- Flame and sterilize wire loops before & after use
- Flame the necks of specimen bottles, culture bottles, & tubes after removing & before replacing caps.
- Inoculate the culture media
- Make slide preparations from specimens after inoculating the culture media
- The inoculated media should be incubated as soon as possible. Incubate the blood agar & MacConkey agar aerobically at 35<sup>0</sup> – 37<sup>0</sup>C.
- After 2 days and onwards of incubation examine both cultures for the common bacteria of skin infection.
- Report the identified bacterial from the culture

To dispatch skin specimens to a microbiology laboratory:

1. Collect the specimen using a sterile cotton wool swab. Insert in a contained of Amies transport medium.
2. Make smear of the material on a clean slide & allow to air-dry in a safe place
3. Label the specimens using a lead pencil. Mark the specimen HIGH RISK if from a patient with suspected anthrax or Bubonic plague (*Yersina pestis*).

4. Send the specimens with a request form to reach the laboratory within about 6 hours.

#### 5.4.2. Gram staining technique

- Required reagents;
  - o Crystal violet stain
  - o Lugol's iodine
  - o Acetone – alcohol decolorizer
  - o Neutral red – 1g/l (0.1% w/v) or safranin

#### Method

1. Fix the dried smear.

Note: when the smear is for the detection of Gonococci or Meningococci, it should be fixed with methanol for 2 minutes (this avoids damaging pus cells)

2. Cover the fixed smear with crystal violet stain for 30-60 seconds

3. Rapidly wash off the stain with clean water

Note: - when the tap water is not clean, use filtered water or clean boiled rainwater

4. Remove excess water, and cover the smear with Lugol's iodine for 30-60 seconds

5. Wash of the iodine with clean water

6. Decolorize rapidly (few seconds) with acetone – alcohol wash immediately with clean water

Caution –Acetone alcohols are highly flammable therefore use it well away from an open flame

7. Cover the smear with neutral red (safranin) stain for 2 minutes

8. Wash off the stain with clean water

9. Wipe the backs of slide clean, and place it in a draining rack for the smear to air-dry.

10. Examine the smear microscopically, first with the 40-x objective to check the staining and to see the distribution of material and then with the oil immersion objective to report the bacteria and cells.

## Results:

- Gram positive bacteria ..... Dark purple
- Yeast cell ..... Dark purple
- Gram negative bacteria ..... Pale to dark red
- Nuclei of pus cells ..... Red
- Epithelial cells ..... Pale red

## Reporting gram smears

The report should include the following information;

- Numbers of bacteria present, whether many, moderate, few or scanty,
- Gram reaction of bacteria, whether gram positive or gram negative
- Morphology of bacteria, whether cocci, diplococci, streptococci, rods, or coccobacilli. Also, whether the organisms are intracellular or extra cellular.
- Presence and number of pus cells
- Presence of yeast cells and epithelial cells

### 5.4.3. Laboratory features of *M.leprae*

#### Morphology

*M. leprae* is a non-motile, non-sporing, straight or slightly curved rod measuring 0.2-0.5 x 5-8 $\mu$ m bacteria. Pointed or enlarged ends are sometimes seen. The organisms can be found singly, in clusters, and in large groups within macrophage cells.

#### Method of collecting and examining a slit skin smear for *M.leprae*

A trained and experienced observer using an aseptic and safe technique must collect a smear for the examination of *M.leprae*.

The skin should be squeezed well and small incision made with sharp blade and the tissue fluid is scraped by turning the blade at a right angle. The specimen is smeared on glass slide.

Sites for slit skin smear include eye brow, ear lobe, elbow gluteal area, knees and active edge of a lesion.

## Procedure

1. Explain the procedure to the patient (or parent if the patient is a child)

The patient should sit with his or her back to the table on which the equipment for taking the smear is placed.

2. Fit a new scalpel blade in its scalpel holder.

Sterilize the blade by wiping it carefully with a piece of absorbent cotton wool soaked in 70% ethanol (alcohol) and flaming it for 2-3 seconds in the flame of a spirit lamp.

Allow the blade to cool; making sure it is not touching any unsterile surface.

3. Wearing protective rubber gloves, cleanse the area from where the smear is to be taken (e.g. earlobe), using a cotton wool swab moistened with 70% ethanol (alcohol). Allow the area to dry.

4. Pinch the skin tightly between the thumb and index finger until it becomes pale due to loss of blood.

- Important: The area must be kept bloodless while the smear is collected because a smear, which contains red cells, will be difficult to examine and report.

5. Using the sterile blade, make a small cut through the skin surface, about 5mm long and deep enough in to the dermis (2-3mm) where the bacteria will be found. Continue to hold the skin tightly.

6. Using a dry piece of cotton wool, blot away any blood, which appears at the site of the cut.

**Note:** providing the pressure is maintained between the thumb and index finger, little or no bleeding should occur.

7. Turn the scalpel blade until it is at a right angle to the cut.

Using the blunt edge of the blades, scrape firmly two or three times along the edges and bottom of the cut to collect a sample of tissue juice and cells

8. Transfer the sample to a slide. Make a small circular smear, covering evenly an area measuring 5-7 mm in diameter.

9. Cover the cut with a small dressing. Instruct the patient to remove the dressing as soon as the cut has healed

10. Ensure the slide is clearly labeled with the patient's name and identification number

11. When the smear has dried, gently heat-fix by holding the smear upper most over the flame of a spirit lamp or the pilot flame of a Bunsen burner for a few seconds. Do not over – heat because this will interfere with the staining of M. leprae.

#### 5.4.4. Ziehl-Neelsen Technique for staining *M. Leprae*

Required

- Carbol-fuchsin stain (Filtered)
- 1% acid alcohol
- Malachite green, 5 g/l (0.5% W/v)

\* If preferred, methylene blue 5g/l may be used instead of malachite green.

#### Method:

1. Cover the smear with filtered carbol-fuchsin stain. Heat the stain until vapor just begins to rise (i.e. about 60<sup>0</sup>C). Do not overheat. Allow the heated stain to remain on the slide for 10-15 minutes (ensure the stain does not dry on the smear).
2. Wash off the stain with clean water. When the tap water is not clean, use boiled filtered rainwater.
3. Decolorize the smear rapidly (about 5 seconds) by rinsing it with 1 % ( **v/v**) acid alcohol.

Caution: Acid alcohol is flammable; therefore use it with care well away from an open flame.

4. Wash carefully with clean water. Then cover the smear with malachite green stain (or methylene blue) for 1-2 minutes
5. Wash off the stain with clean water; wipe the back of the dry slide (do not blot-dry). Protect it from direct sun light.
6. Examine the smear microscopically, first with the 40x objective to see the distribution of material and then with the oil immersion to look for acid-fast bacilli.

#### Result

*M. leprae* ..... Red solid bacilli or beaded forms, occurring singly or in masses



Macrophage cells ..... green\*

\*Blue if methylene blue counter stain has been used

### **Reporting M.leprae smear;**

Report the smear as 'positive' if M.Leprae bacteria are seen or 'Negative' if no bacteria are seen after examining entire smear or at least 100 high power microscope fields.

### **5.5. Diagnosis of Fungal skin infection**

Fungi are usually larger than bacteria and in skin specimens they can be seen by direct microscopy provided the material is first softened and cleared with a strong alkali to digest the keratin surrounding the fungi so that the hyphae and spores can be seen.

Common skin fungal pathogens include;

T.schoenleinii

Microsporum audouinii

Trichophyton verrucosum, T. rubrum, T.pedis, T.cruis, C. albicans

#### **5.5.1. Fungal sample collection and processing**

In skin infections a fungal lesion usually spreads outwards in concentric fashion with healing in the central region. Material should therefore be collected by scraping outwards from the edges of the lesions with a scalpel blade; when there is minimal scaling as, for example, with lesions of the glabrous skin, it is preferable and sometimes necessary to use celotape to remove adequate material for examination.

Specimens from the scalp are best obtained by scraping with a blunt scalpel so that the sample includes hair stubs, contents of plugged follicles and scales. Hairs, which have been cut, rather than plucked, are seldom satisfactory. Nail clipping or scraping could be used for nail infections.

In all cases, cleaning the site with 70% alcohol before taking the specimen may be helpful and should be done if greasy ointments or if powders have been use for treatment. Material is best collected in to folded squares of paper. This permits drying of the specimen,

reduces bacterial contamination and also provides conditions under which specimens may be stored for long periods with out appreciable loss in viability of fungi and parasites.

### 5.5.2. Direct Microscopy

Use dimethyl sulphoxide – KOH reagent (DMSO – KOH)

The addition of DMSO to KOH enables specimens to be examined immediately or after only a few minutes

#### Procedure

1. Place a drop of 20% potassium hydroxide solution on a slide
2. Transfer the specimen (Skin scrapings) to the drop of KOH, and cover with a cover glass. Place the slide in a Petri dish, or other container with a lid, together with a damp piece of filter paper or cotton wool to prevent the preparation from drying out

Note: To assist, clearing skin scales should not be more than 2mm across

- Skin scales and crusts usually take 20-30 minutes when using KOH without DMSO.
  - Clearing keratin can be hastened by gently heating the preparation over the flame of a spirit lamp or pilot flame of a Bunsen burner, taking care to prevent drying or splatter of the corrosive KOH solution. Heating reduces the clearing time using KOH-DMSO reagent.
3. As soon as the specimen has cleared, examine it microscopically using 10x and 40 x objectives with the condenser iris diaphragm closed sufficiently to give good contrast.

**Note:** If too intense a light source is used the contrast will not be adequate and the unstained fungi will not be seen.

**Dermatophytes in skin scales:** look for branching septate hyphae with angular or spherical arthrospores, usually in chains. All species of ringworm fungi have a similar appearance

Fungi need to be distinguished from epidermal cell outlines, elastic fibers, and artifacts such as intracellular cholesterol (mosaic fungus) and strands of cotton or vegetable

fibers. Ringworm fungal hyphae can be differentiated from these structures by their branching, uniform width, and cross-walls (septa), which can be seen when using 40-x objective. In Superficial Candidiasis, the fungus may be seen as budding yeast cells and in the majority of instances mycelium is also present. (Figure: 3)

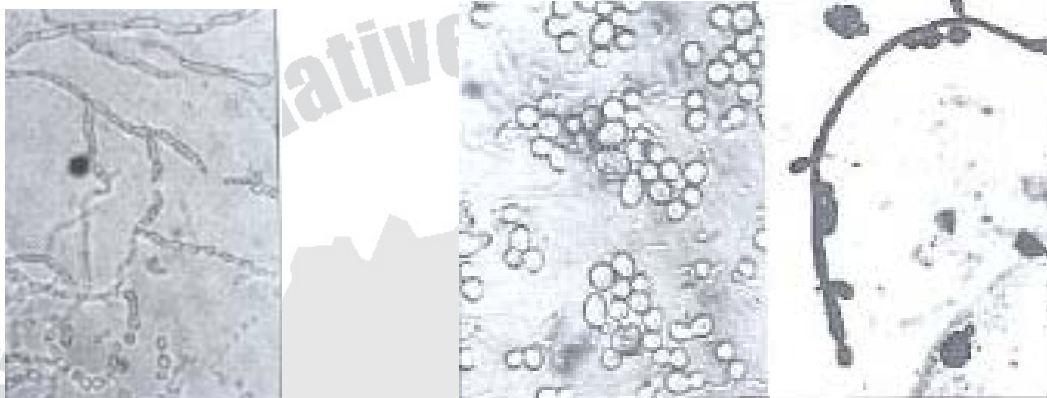

**Figure; 3** fungal hyphae and arthroconidia in KOH preparation of skin scales as seen with the 40x objective

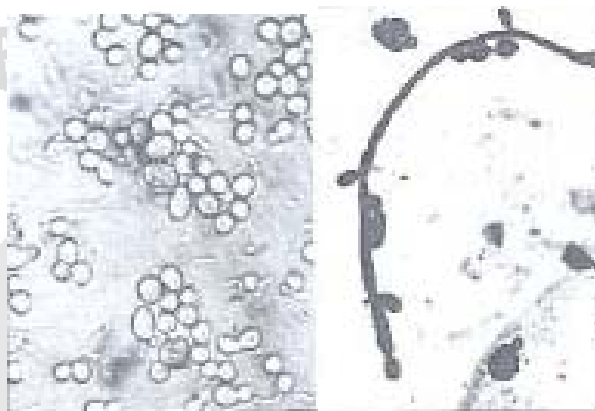

**Figure: 4** **Left;** C.albicans yeasts in wet un stained preparation. **Right:** Gram stain preparation showing gram positive C albicans yeasts and psuedohyphe

### 5.5.3. Wood's Light

Hair infected with *M. audouinii*, *M.canis* and *T. schoenleinii* green fluoresce under Wood's light, a source of a long-wave ultraviolet light. Wood's light can be used to assist clinical diagnosis and to select suitable scalp material for laboratory investigation. It also enables selection of the best part of the hair for culture and direct examination. Care must be taken to differentiate between true fungal fluorescence (bright green) and the auto fluorescence of keratin (dull blue) or the fluorescence of creams and ointments that may have been applied to the lesion.

### 5.5.4. Immunology and serology

The immunological aspects of "ringworm" are incompletely understood. It is clear that a primary infection produces partial local immunity to reinfection but this protection varies in duration and extent depending on the host, the site of infection and the species of Dermatophytes. Cutaneous hypersensitivity (immediate and/or delayed) may occur and

circulating antibodies have been detected in infected individuals but neither phenomenon has been shown to be of any diagnostic value.

## 5.6. Laboratory Diagnosis of cutaneous Leishmaniasis

- Cutaneous leishmaniasis in Ethiopia is caused by the following Leishmania species: *L. tropica*, *L. major*, and *L.aethiopica*

Laboratory diagnosis is based on detecting amastigotes in smears taken from infected ulcers or nodules.

### 5.6.1. Collection and examination of slit skin smears for amastigotes

Material for examination should be taken from the inflamed raised swollen edge of an ulcer or nodule, not from its base or centre, which usually contains only necrotic tissue care, should be taken to avoid contaminating the specimen with blood.

**Note:** secondary bacterial contamination makes it difficult to find parasites and therefore if bacterial infection is present, examination for leishmania amastigotes is best delayed until antimicrobial treatment has been completed and the bacterial infection has cleared.

#### Method

1. Cleanse the area with a swab soaked in 70% v/v alcohol. Allow drying completely.
  2. Firmly squeeze the edge of the lesion between the finger and thumb to drain the area of blood (protective rubber glove should be worn)
  3. Using a sterile scalpel black, make a small cut in to the dermis and blot may any blood scrape the cut surface in an out ward direction to obtain tissue juice and cells.
  4. Spread the material on a clean slide using a circular motion and working outwards to avoid damaging parasites in those parts of the smear that have started to dry.
- The smear must be thinly spread and not left as thick 'dab' smear- parasites will be difficult to find in thick smears.

5. When dry, fix the smear by covering it with a few drops of absolute methanol – Fix for 2-3 minutes and stain the smear using the Giemsa technique.

### 5.6.2. Giemsa staining techniques

Reagents required: -

- Giemsa stain
- Buffered water, PH 7.1 – 7.2 or
- Buffered saline, PH 7.1- 7.2

#### Method

A. Immediately before use, dilute the Giemsa stain to make 10% solution. This solution requires minutes staining time;

*Preparation of 10% solution:* Measure 45 ml of buffered water

Ph 7.1 - 7.2 in a 50ml cylinder- Add 5 ml of Giemsa stain (to 50 ml mark) and mix gently

- A. Place the slides in a shallow tray, supported on two rods, in a coplin jar, or in a staining rack for immersion in a staining trough
  - B. Pour the diluted stain in to the shallow tray, coplin jar, or staining thoroughly and stain for 10 minutes
  - C. Wash the stain from the staining container using clean water
  - D. Wipe back of the slide clean and place it in a draining rack to air –dry.
6. When the smear is dry, spread a drop of immersion oil on it and examine first with the 10 x and 40x objective to detect macrophages which may contain amastigotes (the parasites can also be found outside macrophages) use the 100-X oil immersion objective to identify the amastigotes.

#### Morphological characteristic of amastigotes

- Amastigotes are – small round to oval bodies measuring 2-4  $\mu\text{m}$

- Can be seen in groups inside blood monocytes (less commonly in neutrophils), in macrophages in aspirates or skin smears, or lying free between cells
- The nucleus and rod-shaped kinetoplast in each amastigotes stain dark reddish mauve
- The cytoplasm stains pale and is often difficult to see when amastigotes are in-group.

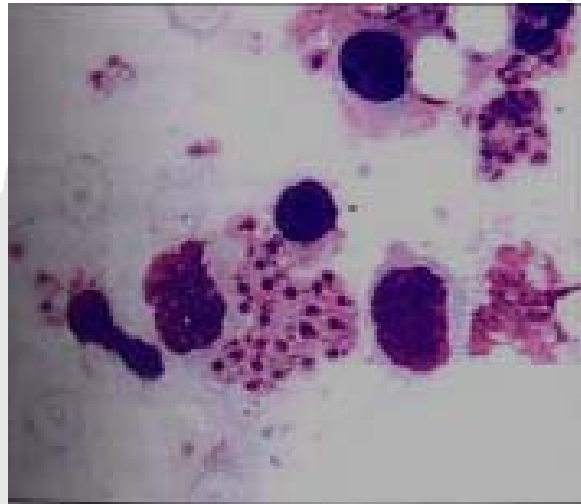

Figure: 5 Leishmania amastigotes in Giemsa stained skin smear

### 5.6.3. Serological diagnosis of cutaneous leishmaniasis

Because of the poor antibody response in continuous Leishmaniasis serological tests are of little value in diagnosis. There is however a cellular response, which is the basis of the leishmanin, skin tests.

## UNIT SIX

# SATELLITE MODULE FOR ENVIRONMENTAL HEALTH PROFESSIONALS

(Diploma level)

## 6.1. Introduction

### 6.1.1. Purpose and use of this satellite module

This module is intended to be used by environmental health professionals to provide them with basic issues that are not discussed in the core module but essential to undertake prevention and control activities for common skin diseases.

### 6.1.2. Directions for using the Module

- Before reading this satellite module be sure that you have completed the pre-test and studied the core module.
- Continue reading this satellite module, and when you have completed the satellite module test yourself by the pre-test again.

### 6.1.3. Pre-test for Environmental Health Professionals

#### I. Choose the best answer for all of the following questions

1. From healthy skin, approximately  $10^7$  particles are disseminated into the air each day, and \_\_\_ % of the skin squamous contain viable bacteria
  - A. 50%
  - B. 25%
  - C. 10%
  - D. 75 %
  - E. None
2. A measure taken at an individual level to prevent the transmission of skin diseases from source to susceptible host is called \_\_\_\_\_
  - A. Drug treatment
  - B. Insecticidal application
  - C. Vaccination
  - D. Personal hygiene

- E. B & C
3. Of the following skin diseases which one is of parasitic origin?
- A. Cutaneous Leishmaniasis
  - B. Impetigo
  - C. Athlete's foot(T. Pedis)
  - D. Herpes simplex
4. Which one of the following skin diseases has an unclear mode of transmission?
- A. Leishmaniasis
  - B. Leprosy
  - C. Wart
  - D. None
5. Which of the following conditions help bring about fungal infection?
- A. Warmth,
  - B. Humidity,
  - C. Poor air circulation
  - D. Over crowding
  - E. All

**II. Answer true or false for each of the following questions**

6. In areas with high humidity, wearing tight and thick clothing can help prevent fungal infections.
7. The dermatologic and systemic reactions to arthropods are generally specific to one particular arthropod and are the same to every person.
8. Scabies is a disease caused by an arthropod called scabies mite; therefore it is not acquired by close contact with an infected individual.
9. As scabies is a disease caused by an arthropod called scabies mite, its control measure especially in epidemic cases, consists of fumigation with insecticides to the living room as best alternative and thus it has no individual treatments.

**III. Give short answers for all of the following questions.**



10. List 4 basic ways by which injurious chemicals produced by arthropods are introduced into or on to the body of human and other animals.

- A. \_\_\_\_\_
- B. \_\_\_\_\_
- C. \_\_\_\_\_
- D. \_\_\_\_\_

#### **6.1.4. Learning objectives**

##### **6.1.4.1 General objective**

The general objective of this module is to equip environmental health professionals with knowledge and skills needed to deal with preventive and control measures of common skin diseases.

##### **6.1.4.2 Specific objectives.**

After completing of reading this module, environmental health professionals will be able to:

- Describe common skin diseases.
- List important prevention and control measures.
- Portray the significance of hygienic behavior in the mitigation of common skin diseases.

#### **6.2. The Skin and Diseases Associated with It**

Skin diseases are common through out Africa and are dominated by bacterial and superficial fungal infections. The eczemas are ubiquitous. In some areas discoid lupus erythematosus is common and lichen planus is seen far more frequently in temperate countries. There are the more chronic infections –Leprosy, Leishmaniasis, Scabies and Onchocerciasis– which affect the skin so distinctively; the whole range of ulcers of the skin; and the serious effects on the skin of protein malnutrition. For general preventive and control methods on such common skin infections especially for environmental health professionals, this satellite module concentrates on the general classifications of

common skin diseases as: *Bacterial, Fungal and Viral skin infections*, and *Skin problems due to arthropods (scabies, leishmaniasis)*, acne and atopic dermatitis.

### **6.3. Prevention and control of Bacterial Skin Diseases**

Sweat and oily secretions from the skin cause dust to stick on its surface. This clogs the skin pores and interferes with the natural function of the skin. Moreover, bacteria can readily breed on the surface of the skin to cause various diseases. If germs that settle on the skin as a result of poor personal hygiene are able to multiply and invade the skin, the barrier to protect internal organs of the body is lost and systemic infections can possibly occur. Mostly bacteria and parasites are able to invade via broken skin or mucous membranes; hence intact skin is an important human defense

#### **6.3.1 Case treatment**

The treatment of bacterial skin infections includes:

- Appropriate antibiotics
- Drainage of pus collection
- Surgical removal of dead tissues
- Removal of foreign bodies (eg. Sutures, wood splinters, etc.) that may be a focus of persisting infection
- Treating the underlying skin diseases.

#### **6.3.2 Personal hygiene**

Hygiene is defined as conditions or practices conducive to maintaining health and preventing disease, especially cleanliness. Parasites cause disease if the source, susceptible host and suitable environment exist. Personal hygiene is therefore, a measure taken at individual level to promote personal cleanliness so that transmission of diseases from source to susceptible hosts is prevented. It can be seen the most effective line of defense in protecting the health of communities where treatment options are limited due to lack of health care delivery systems. Many health problems are due to poor hygiene. The benefits of safe water supply and sanitation efforts in a given community can easily be lost if the communities still engage in poor personal hygiene. Health related programs, therefore, should consider carefully the changes in hygiene

practices needed to complement improved water and sanitation facilities. To achieve these goals, hygiene education plays a central role and has to be applied in a sustainable way. For a more detailed explanation on personal hygiene the reader is advised to refer the lecture notes on Personal Hygiene prepared by the Carter Centre for Ethiopian Health center team.

### **Tips on personal hygiene for every day items**

Here are some important points that environmental health professionals need to consider in addressing the promotion of personal hygiene which is important in the prevention and control of common skin infections.

- Washing the body with warm water and soap preferably every day to remove dust and dirt.
- After showering or bathing ensure thorough drying of the body. Take special care to dry between the toes, under the armpits and in the groin region.
- Regular exposure of the skin to air and sunlight is beneficial
- After a bowel action, ensure the anal area is cleansed from the front backwards and not in the reverse direction. This reduces the chance of infections being passed to an individual's sexual organs.
- Wear the right size and type of clothes to suit local weather.
- Change your clothes, especially underwear, socks, stocking or tights on a regular basis-preferably daily.
- Launder towels, washcloths, sheets, pillowcases, duvet covers, and bedclothes on a frequent and regular basis.
- After washing, hang clothes and if possible, iron it before wearing
- Do not share cleaned clothes or towels.
- Do not share brushes, combs, toothbrushes or toilet articles
- Keep washbasins, toilet seats, bathrooms, kitchens and fixtures thoroughly clean.
- Use disposable tissues instead of handkerchiefs
- Use paper towels or tissues in the kitchen
- Items which can not be washed such as mattresses, thick rugs pillows should be given an outdoor airing in bright sunlight when possible
- Air your living accommodation for several hours on a dry sunny day.

### **6.3.3. Leprosy**

Leprosy is caused by mycobacterium leprae. Mycobacterium leprae is not probably as communicable as M. tuberculosis. However, the portal of entry is believed to be through the nasal route, skin to skin contact and, only those untreated patients with multibacillary leprosy are infectious discharging the bacilli through nasal and untreated nodules. Mycobacterium leprae has a very long multiplication time and the majority of the population has strong immunity, therefore it requires a prolonged exposure to acquire the disease. Persons living close to mycobacterium case needs to be examined for leprosy. Because leprosy has long incubation period, most patients are asymptomatic at early stage of the disease. Thus it is important to create awareness at leprosy through health education for early diagnosis and treatment.

#### **6.3.3.1 Epidemiology**

The disease usually occurs in persons who live in endemic areas, including Africa, Asia, and the Pacific Islands. Also at risk are those people with a long term exposure and frequent close contact with leprosy patients.

Today, a great majority of the global leprosy burden is concentrated in certain limited geographical areas, with the top 11 endemic countries representing 90% of the prevalence and detection worldwide. In Ethiopia, the prevalence of leprosy is 0.8 per 10,000 populations.

#### **6.3.3.2 Prevention and control measures**

##### **Case detection and treatment**

Multidrug therapy (MDT) rapidly reduces the infectivity of known patients, but it has not yet demonstrated that it is able to prevent new cases from occurring in the community, perhaps because of previous exposure except that BCG vaccination helps in preventing tuberculoid form of leprosy.

#### **6.3.3.2.1 Prevention of disability and rehabilitation**

Activities aimed at preventing impairment and disability in leprosy patients are important and depend on a good relationship between health worker and patient.

Regular health education on eye, hand, and foot care helps to reduce secondary infection. In order to prevent disability, early detection of cases is a high priority, however, early detection and treatment with MDT will not prevent all nerve function impairment. Therefore, patients should be regularly examined and aware, so that reactions and new nerve function impairment can be detected and treated appropriately. In addition there should be no restriction from school or work for people with leprosy to avoid stigmatization.

### **6.4. Skin fungal infections**

Normal skin is impenetrable to microorganisms. However, some microbes have developed the ability to destroy the upper layer of the skin to enable their colonization. Among the various skin infections, infections caused by fungi (mycoses) pose a major challenge.

Warmth, humidity, sweating, over crowding and poor air circulation all help bring about these fungal infections. But they are contagious too. Athlete's foot is believed to be passed on locker room and shower floors, and by sharing foot wear and socks. You can acquire tinea versicolor from vinyl surfaces of weight lifting benches; and of course ringworm is contagious through direct contact with infected people (usually kids) and animals (dogs).

Because of all these factors, prevention is a matter of both personal hygiene and minimizing contact with potential carriers or contaminated objects.

#### **6.4.1 Prevention and control of fungal infections**

- Health education and home health care are important to eradicate the disease causing organism

- Heat, friction and other factors predisposing to the infection, like excessive heat and humidity, nylon underwear tight-fitting clothing and the prolonged wearing of a wet bathing suit should be avoided.
- The groin area should be cleansed, dried thoroughly and dusted with a topical antifungal agent (toinaftate) as a preventive measure, because the infection is apt to recur.

## Preventing skin fungus infections

### Personal Hygiene

- ☞ Use of anti-perspirants and talcum powder to keep high-risk areas dry
- ☞ People susceptible to athlete's foot should use an anti-fungal powder ,anti-fungal socks and clean cotton
- ☞ In high humidity, keeping clothing loose and light; avoiding knits and less breathable synthetic materials can also be used to prevent and control skin fungal infections

### Avoidance

- ☞ Don't share towels or clothes
  - ☞ **Wear thongs or other footwear in public locker rooms, pools, and showers**
  - ☞ **Always wear a thick T-shirt or sweat shirt and long shorts or sweat pants while sharing exercise equipment.**
- ☞ Wipe off vinyl surfaces with a dry towel before using exercise equipment.

## 6.5. Viral Skin Infections

Viruses may remain localized to the body surface through which they entered, or cause generalized infections through viremia and subsequent localization in particular organs. Sweating, chafing, and occlusive clothing form a perfect environment for viral skin infections. Any breach in the skin from cuts, abrasions, or lacerations increase the risk of infection.

### 6.5.1 Prevention and control of Viral skin infection

#### 1. Early detection and treatment

Early detection and treatment of cases will help the spread of viral infections to others. The three main types of treatments are:

- ↳ Mechanical,
- ↳ Chemical, and,
- ↳ Immunologic

2. Enforcing the practice of good personal hygiene, such as regular bathing, laundering clothes, not sharing towels, soaps and wearing sandals in communal showers.

3. Avoid contact with vesicles.

4. Herpes lesions must be completely dry and crusted and should be covered until completely resolved.

5. Cover all warts until completely resolved.

6. Care providers should wear gloves.

7. Educating the people about prevention strategies is an important task.

8. Warm showers are recommended in herpes simplex-I in order to cleanse the infected area and to reduce secondary bacterial infection. Afterwards, towel dry gently, or dry the area with a hair dryer on a low or cool setting.

## 6.6 Arthropods and skin disease

Arthropods have been associated with human beings since the age of antiquity. Although arthropods are important in maintaining the ecosystem we live in, they can adversely affect our health in several ways:

- (i) By causing direct, non allergic, local tissue damage through stings, bites, exposure of toxic body fluid (blister beetles), and tissue invasion (sand flea and brown recluse spider).
- (ii) By causing allergic reactions to their secretions, skins, or scales.
- (iii) By producing systemic toxicity, such as that caused by neurotoxin release (black widow spider and scorpions).
- (iv) By transmitting diseases.

#### **6.6.1. Scabies**

Scabies is an arthropod-associated diseases caused by the mite.

#### **6.6.2 . Magnitude Of The Problem**

An increased prevalence is seen during wars and famines. In Europe, America and other developed countries, the rise and fall of this disease reflects the intervention of health promotion strategies. In under developed countries like Africa, it may be chronically endemic, particularly among the poor, overcrowded, and dirty who have close contact with an infected individual. Epidemic scabies have been reported in South Africa. Scabies may be transmitted sexually. Scabies can be complicated by streptococcus pyogenes infection (pyodema) sometimes causing acute glomerulonephritis. Scabies is often worse during the rainy season.

#### **6.6.3. Epidemiological factors**

*Sarcoptes scabie* var. *hominis*, the itch mite, is the causative agent. Mites which can not be separated morphologically from *S. scabie* are found on numerous wild and domesticated animals, including dogs and pigs, but such mites very rarely infect humans. However, if they do the infection can persist for several weeks or even months. Scabies mites on animals are considered to be the same species as those found on people but physiologically adapted for life on non-human hosts.

Scabies mites are not vectors of any disease but hyperinfestation of the skin with *Norwegian itch (crusted scabies)* is especially contagious. There are at least 300 million scabies cases annually. In animals the condition caused by scabies mites is referred to as mange.



#### 6.6.4 Prevention and control of scabies

All cases of scabies can be cured. There are no resistant infections. Methods aimed at killing the mites will do little to immediately alleviate the nuisance and irritation caused by the rash, although this will eventually disappear. Preliminary antibiotic may be necessary if secondary bacterial infections have become established. Patient requires scrub bath before treatment but avoid vigorous scrubbing with a brush this may damage the skin and expose the patient to secondary infection. Always advise the patient to bath before treatment for general hygienic reasons. However, in epidemics of scabies all cases should be treated at the same time and it is important to boil and iron used clothings in order to prevent reinfection.

A 20-25% benzyl benzoate emulsion can be painted on a patient from the neck downwards. After allowing some 5-10 minutes for this application to dry the patient can re-dress in clean clothes. The patient should not bathe for 48 hours. The treatment should be used for 3 consecutive days. Only in rare cases does dermatitis result from the use of benzyl benzoate and this is more likely to happen in young children.

*Mitigal* is a yellowish oily liquid sulphur preparation, which is painted undiluted over the body from the neck downward for one week. A single treatment should be 100% effective. A mild form of dermatitis may be produced in some people. *Tetmosol* is another sulphur compound sometimes used to treat scabies. It is slow in its action and usually about three treatments 24 hours apart are recommended for a complete cure. It is therefore of limited use in mass community treatments. It has been combined with soap and sold as *temosol soap*, and in this form, when regularly used in washing and bathing, it has a slow curative effect and also acts as a prophylactic.

Although these two sulphur preparations and benzyl benzoate are still used, a better treatment for scabies consists of applying a 1% gamma benzene hexachloride cream or lotion, 1% Malathion aqueous emulsion or 5% permethrin cream (Elimite). Permethrin actually should be used very carefully especially when applied to infants and small children. A single treatment has a high success rate. A second application 2-7 days

later, if this proves possible, ensures a complete cure. Crotaimition (Eurax) applied as a 10% cream or lotion is a very safe treatment but weak scabicide. However, two times daily applications are needed. More recently it has been shown that ivermectin given, as a single oral dose of 100-200  $\mu\text{g}/\text{kg}$  body weight is effective in killing scabies mites.

With a highly contagious condition such as scabies, it is important to treat all members of a family or community living in close association, not just the individual with a particularly bad infestation of mites, otherwise re-infestation will soon occur.

The density of house dust mite allergens can be assessed by a test, which measures the concentration of mite excreta in dust.

Mites and associated fungi can be controlled by decreasing the humidity in rooms, improving ventilation and removing dust. Bedrooms and living rooms should be aired regularly, or other measures should be taken to reduce dampness. The shaking of bedclothes and frequent washing of sheets and blankets reduce the availability of food and therefore the number of mites. Vacuum cleaning of beds, carpets and furniture is also effective. General insecticides used for pest control are not effective but a special product containing benzyl benzoate is available, which destroys mites when applied to mattresses, and upholstery.

## **6.7. Leishmaniasis**

Leishmaniasis is a term used to describe a number of closely related diseases caused by several distinct species, subspecies and strains of leishmania parasites. The disease occurs in three main clinical forms.

- Cutaneous
- Mucocutaneous
- Visceral

Phlebotomine sandflies are the vectors. The epidemiology of leishmaniasis is complex, involving not only different parasite species but also strains of parasites. Most types of

leishmaniasis are zoonotic. The degree of human involvement varies greatly from area to area.

The epidemiology of this disease is largely determined by:

- The species of sandflies, their ecology and behavior;
- The availability of a wide range of hosts;
- The species and strains of leishmania parasites.

### **a) Cutaneous Leishmaniasis**

Known under a variety of common names, (e.g.oriental sore in old world), uta or chiclero ulcer in new world.

It is caused by leishmania major, leishmania tropica and leishmania aethiopica in Ethiopia.

It is characterized by typical ulcer that starts as a nodule at the site of bite, and then a crust develops in the middle followed by ulcer.

### **b) Diffuse cutaneous leishmaniasis**

It is usually caused by leishmania aethiopica in Ethiopia. It causes widespread cutaneous nodules or macules on the body

## **6.7.1. Prevention and control of leishmaniasis**

### **1. Case treatment**

Simple cutaneous leishmaniasis usually heals without treatment and renders the person immune to other infections with the same parasite species.

### **2. Personal protection**

Individuals can prevent infection by avoiding being bitten by sandflies. It is recommended that personal protection measures be taken, such as repellents, fine mesh screens, insecticide treated clothing and/ or insecticide-treated bednets are used.

### **3. Application of insecticides**

- Spraying the interior surfaces of houses with residual insecticides, such as DDT, Malathion, propoxur, etc.

- If outdoor resting sites are known they can be sprayed with residual insecticides.

#### **4. Application of basic sanitation**

This is aimed at abolishing the breeding sites around human habitation, such as proper disposal of refuse and rubbish heaps; filling of cracks and holes in the soils and walls.

#### **5. Control of Animal Reservoir**

In Ethiopia, control measures were carried out against the rock hyrax, a wild animal reservoir of leishmaniasis, where by reduction of the prevalence of leishmaniasis has occurred. Similarly control measures can be taken against foxes and dogs.

### **6.8. Acne Prevention and control**

#### **1. Acne diet**

In some patients acne is precipitated by special diet. Therefore, it is essential to become familiar with foods that heal, vegetable juices, and fats that heal, unrefined sea salts.

#### **2. Body cleansing**

- Body cleansing is extremely important part of every prevention and curing programme. Always cleanse with soap and water.

#### **3. Physical activity**

Physical activity helps cleansing. It brings balance and relieves stress. Psychophysical activities will help you balance your body and will help you relief accumulated stress.

### **6.9 Prevention and control measures of Atopic dermatitis**

Atopic dermatitis is recurrent disease that affects the skin. It is not contagious. Atopic refers to a group of diseases where there is often an inherited tendency to develop other allergic conditions, such as asthma and hay fever.

#### **6.9.1 Case treatment**

Treatment is more effective when a partnership develops that includes the patient, family members and doctor.

### 6.9.2 Controlling Atopic dermatitis:

- ❖ Prevent scratching or rubbing whenever possible
- ❖ Protect skin from excessive moisture, irritants, and rough clothing
- ❖ Maintain a cool, stable temperature and consistent humidity levels.
- ❖ Limit exposure to dust, cigarette smoke, pollens, and animal dander
- ❖ Recognize and limit emotional stress
- ❖ Eliminate allergic triggers in environment.



# UNIT SEVEN

## SATELLITE MODULE FOR HEALTH EXTENSION WORKERS

### 7.1 Introduction

#### 7.1.1. Purpose and use of this satellite module.

This module is intended to be used by health extension workers and is believed to provide them with basic information that is not included in the core module. However, it is essential to undertake the management, prevention and control activities on common skin infections.

#### 7.1.2. Directions for using the module

- Prior to reading this satellite module please be sure that you have completed the pretest and studied the core module.
- Continue reading this satellite module.

#### 7.1.3. Pre-test

Choose the best answer for all of the following questions

1. Which of the following conditions help bring about fungal infection?
  - a. Warmth,
  - b. Humidity,
  - c. Poor air circulation
  - d. Over crowding
  - e. All
2. Of the following skin diseases which one is of parasitic origin?
  - a. Cutaneous Leishmaniasis
  - b. Impetigo
  - c. Athlete's foot
  - d. Herpes simplex
3. All are bacterial skin diseases except
  - A) Carbuncles

- B) Furuncles
- C) Boil
- D) Eczema

4. Which of the following statement is false about scabies?

- a. It considered as unhygienic disease
- b. It is common in a people who are living together
- c. The drug of choice is antibiotic ointment
- d. The mode of transmission is skin to skin contact
- e. None of the above

5. In the community, those patient who develop bed sore as a result of chronic illness, can be well managed by health worker through

- a) Frequent changing position
- b) Providing bed bath and back care
- c) Not allow to eat that much vitamin and protein until the wound is healed
- d) All except C
- e) None of the

6. Which one is viral infection?

- a) Tinea pedis
- b) Chicken pox
- c) Leishmaniasis
- d) Impetigo
- e) None of the above

7. As being the health worker of the community, all activity has to be carried out respect to leprosy disease patient except:

- a) Teach the patient about disease
- b) Avoid any discrimination and stigmatization from the community
- c) Treat any skin reaction that occurred from disease process
- d) Teach the patient, on how to protect his/her wound form danger
- e) None of the above

8. Which of the following is the role of health worker who is dealing with a patients having wound secondary to accident?
- a) Wash the wound with strong antiseptic solution and then wash your hands
  - b) First wash your hand with running clean water and soap and then wash the wound
  - c) Before touching the wound first wash your hand and then clean the wound with soap and clean water and then wash your hand at the end of your procedure
  - d) All are possible answer
  - e) None of the above
9. All skin diseases are due to allergic problems. A) True B) False
10. Scabies is a disease caused by an arthropod called scabies mite; therefore it is not acquired by close contact with an infected individual. A) True B) False

#### **7.1.5. Learning objectives**

##### **7.1.5.1. General objective**

The general objective of this module is to equip health extension workers with the knowledge and skills needed to deal with the management, prevention and control of common skin diseases.

##### **7.1.5.2. Specific objectives**

After complete reading of this module, health extension workers will be able to:

- Describe common skin infections
- Explain the management of common skin infections
- Mention important prevention and control measures
- Portray the significance of hygienic behavior in the mitigation of common skin disease.

## **7.2. The skin and its parts**

The major components of the system are the following:

- Skin
- Hair



➤ Nails

These components not only reflect person's general health status, they also serve as indicators of more general disturbances.

### 7.2.1. The Skin

- The skin is the boundary between ourselves (the internal organs) & what is around us)
- It reflects internal changes and reacts to changes in the environment
- It is composed of tissue that:
  - Grows
  - Differentiates &
  - Renews itself

The entire layer of the epidermis is replaced about every 15 to 30 days, depending on its location. This cell turnover is greatly accelerated in such diseases as psoriasis.

### 7.2.2. Functions of the Skin

1. Protect cells and their internal environment
2. Structural barrier to invading micro-organisms
3. Temperature regulation
4. Lubrication and water proofing
5. Sensation
6. Formation of vitamins D
7. Immunological sensitization

## 7.3. Bacterial skin infection

### 7.3.1. Impetigo

It is the superficial infection of the skin

#### 1. Causes:

- Streptococcus
- Staphylococcus

- Although impetigo is seen at all ages, it is particularly common in children living in poor hygienic condition.
- It could be primary starting on normal skin or secondary to underlying skin diseases such as pediculosis, scabies, insect bites, and eczema

Common sites: Face, hands, neck and extremities

## 2. Treatment:

- Systemic antibiotic therapy
- Antiseptic to clean the skin
- Wash hand frequently
- Avoid scratching
- Teach the patient
- Arrange follow up

### 7.3.2. Cellulites

It is a bacterial infection of skin and subcutaneous tissue.

**a). Cause:** streptococcus is the most frequent cause

#### **b). Signs and symptoms**

- Fever
- Heat at area
- Edema
- Pain and tenderness of affected area

#### **c). Treatment:** -

- Promote skin care & don't scratch
- Encourage rest so that the infection remains localized
- Give anti pain and analgesic
- Send to health facility for parenteral treatment

**7.3.3. Furunculosis (boil):** Is an acute inflammation arising deep in one or more hair follicles and spreading in to surrounding dermis.

It is the deeper form of folliculitis

- Furuncles may occur any where on the body but are more prevalent at areas where irritation and pressure, friction, perspiration such as the back of the neck, the axially buttock.
- Furuncle or Boil starts as small raised, painful tender, papule or nodule with erythema and oedema, central pore discharging pus and commonly seen in hair bearing area of the body

**Treatment:** - Systemic antibiotic

- Skin care
- Do not squeeze or don't apply pressure
- Give local care

#### **7.3.4. Carbuncle**

Is an abscess of skin and subcutaneous tissue representing an extension of furuncle that has invaded several hair follicles and is larger and deeper.

##### **1. Cause: Staphylococcal infection.**

- Carbuncles appears most commonly in the areas in which the skin is inelastic
- The back of the neck and the buttock are more common sites
- Furuncle and carbuncle usually occur in a patient with underlying diseases.
  - Diabetes mellitus
  - Immunosuppressive conditions

##### **2. Treatment:**

- Do not squeeze
- Warm and moist compresses increases visualization and hasten resolution.
- Clean skin gently
- Dress the wound properly
- Disposable glove should be used during wound care
- Drain the abscess
- Systemic Antibiotic should be given at health facility

### **7.3.5. Leprosy (Hanson's Disease)**

It is a chronic bacterial infectious disease caused by bacteria called mycobacterium leprae and which can affect skin, peripheral nerves and other organs like respiratory tract and eyes.

#### **1. Occurrence of the disease**

The disease will occur in all ages, both sexes and every socioeconomic groups of the society.

#### **2. Mode of transmission**

Is through inhalation of droplet nuclei from an infected person and skin-to-skin contact with lepromatous nodules.

#### **3. The cardinal signs of leprosy**

- Hypopigmented macule or patch (reddish skin) with definite loss of sensation
- Positive skin test for Acid fast bacilli
- Enlargement of nerves or nerve damage

Therefore, one can diagnose leprosy if one of the above is present

#### **4. Classification of leprosy**

For the purpose of multi drug therapy (MDT) leprosy will be classified as paucibacillary (PB) and Multi bacillary (M.B.) and this classification will be based on the number of skin lesion and on skin smear result.

#### **5. Paucibacillary**

In (PB) patient can have one to five skin lesions

#### **6. Multibacillary**

- Patient with six or more skin lesion
- Patient with less than six skin lesion and have positive skin smear result

#### **7. Leprosy reaction**

In leprosy, there is leprosy reaction manifested by inflammation of the skin caused by immunological reaction to the bacteria. Two types of reaction occur. Type I (reversal reaction) and type II erythema nodule leprosum

Type I is common in PB leprosy, present with inflammation in the skin patches with swelling, redness, warmth and there is some discomfort and painful. There may be inflammation of peripheral nerves with pain.

### **8. How to examine leprosy patches and reaction**

- Check the sensation by instructing the patient to close his eyes
- Examine the patch for sign of inflammation (swelling redness, heat and pain)
- Examine the hand and feet for sign of loss of sweat

### **9. Management**

- Make sure that the patient is leprosy case and if so, refer him/her to health center to start patient on MDT.
- If you detect leprosy reaction refer patient for prednisolone treatment
- In the mean time, encourage taking rest and applying splint on affected limb to restore muscle tone.
- If the patient has wound, clean the wound with warm water and soap and put clean gauze or pads.
- If patient has loss of sensation on the foot advice to use foot wear
- Tell the patient to apply Vaseline or other vegetable oil on dry part of the skin, hands and feet.
- Give health education to the patient and a family and community about the disease
- Teach the community, as to not discriminate and stigmatize the patient
- If the patient is recovered, help the patient to do passive and active exercise for maintaining range of movement and restore muscle strength.
- Follow the patient condition and make sure the patient is getting the ordered medication.

## **7.4. Leishmaniasis**

It is protozoal infection of the skin and mucous membrane and visceral organs (liver and spleen)

### **1. Mode of transmission**

The infection will be caused by bite of insect called sand fly

## **2. Incubation period**

From days to months

## **3. Source of disease**

Human being and animals like rat, dog and cats

## **4. Clinical picture**

Single and multiple lesions will be localized on the face extremities: mouth, nose larynx and pharynx that have characteristics of papules progress to destruction of tissues (Ulcer) Pain on the part of lesion

## **5. Management**

1. Re assure the patient
2. Reduce pain by giving anti pain
3. Clean the ulcerated part with soap and water.
4. Refer patient for treatment with pentostan or pentamidine

## **7.5. Acne vulgaris**

### **1. Risk factors**

- Increased sex hormone level
- Increased stress level
- Sebaceous gland over secretion of sebum, proliferation of bacteria, excess keratin formation in the follicular duct.
- Age: greatest in adolescent after puberty

### **2. Characteristic or features of acne Vulgaris**

- Initial formation of a comedo (Black head) or white head.
- Progress formation of comedones, papules, pustuls.
- Inflammation reaction results when comedonal material is released to surrounding skin by ruptured follicles
- Subsequent scarring is potential risk.

Treatment: Goal of care to promote recover of patient with minimum residual scar.

### 3. General care of patient

- Identify acne properly
- Instruct the patient not to scrub, rather advice to wash with warm water and soap
- Explain or teach importance of maintaining cleanliness of skin
- Encourage hand and washing of the area
- Avoid scratching that causes secondary bacterial infection
- Encourage to ventilate any discomfort
- Encourage to shorten nails

**NB.** Refer if not improved after some days of follow up and care

### 7.6. Psoriasis

It is chronic inflammation of the skin producing dry scaly lesions, exacerbation and remission

#### 1. Clinical appearance:

- Common during adolescent
- Raised, erythematic papule or plaques, covered with loose scales
- Silvery white scale
- Easily bleeding when scale is removed
- May be precipitated by trauma
- It is gradual or sudden onset

#### Risk factors:

- Infection (HIV)
- Alcohol consumption
- Cigarette smoking
- Trauma

## 2. Treatment

- Avoid itching
- Encourage bath and skin care
- Soak in warm bath
- Encourage and adequate rest and good nutrition
- Refer to health facility

## 7.7. Allergic Skin Diseases

### 7.7.1 Contact Dermatitis

It is the inflammatory disease of the skin and is very common

#### 1. Risk factors of contact dermatitis

- Contact with irritant substances such as strong soaps and acids etc.
- Contact of allergic skin with agents such as poison, cosmetics, hair die, soaps, clothing, insecticides
- Exfoliation due to drug reaction.

#### 2. Characteristics of contact Dermatitis:

- Erythematous, papule, vesicles
- Vesicles may be ruptured followed by crusting and scaling
- Itching and burning leads to scratching and then resulted in infected lesions.
- Patching can be irritable and psychological instable.

#### 3. Treatment care:

Goal of treatment patient should be recovered with minimum scarring and mucosal damage.

#### 4. General nursing care:

- Try to avoid the irritant factors or substances
- Avoid the patient not scratch
- Antibiotic ointment may be applied if there is infection
- Avoid stress
- Encourage skin care daily and regularly
- Corticosteroid can be given to reduce inflammation
- Provide patient and family with psychological support



- Arrange following up
- NB.** Refer if not improved

### 7.7.2 Atopic Dermatitis

Allergic disorder of the skin but in this case the patient inherits or increased tendency of getting sensitization to various antigen in his environment. This tendency is inherited as received character most patients have immunologic abnormalities.

#### 1. Signs and symptoms

- Itching, erythematous, papulovesicular lesion
- In severe case; exudates, crusting the lesion and elapse
- It can happen in, children, adolescent and adult

#### 2. Treatment

- Keep the skin dry and clean
- Encourage daily bath
- Use or denary soap
- Avoid application of oil
- Wash with normal saline and potassium permanganate
- Application of corticosteroid ointment
- Teach the patient about the disease
- Refer if not improved

### 7.7.3 Eczema

It is the superficial inflammatory process primarily involves the epidermis and can occur in adult also it is known as infantile dermatitis.

**1. Causes:** What really causes eczema is unknown

#### 2. Risk factors

On allergic sensitivity to food, house dust, mites, pollens, or small inhalants

### 3. Characteristics

- Red, minute papules and vesicles
- Persistent itching
- Weeping, oozing, crusting and scaling lesion present
- Lichenification (thick and hardened skin) lesion

### 4. Treatment

- Avoid the risk factors
- Apply lotion and ointment
- Teach the patient about the disease (personal hygiene cleanliness of environment)
- Reassure Patient
- Arrange follow up

## 7.8. Wound

### Wound is a breaking of skin

#### 1. Classification of wound

1. Abrasion: Caused by rubbing or scraping. They are shallow or superficial wounds.
2. Incised: Sharp cuts that tend to bleed freely. They are caused by sharp edged object such as knife, glass etc.
3. Lacerated: are jagged or irregularly wound often associated with much tissue damage and that can be caused by wire, an explosion and stone. Foreign material as cloth, wood, and metal pieces are often driven in to the wound and often not heal quickly and may leave large scar.

#### 2. The health worker responsibility for wound

##### I. For wounds in which hemorrhage is not sever

1. Wash you hands thoroughly with clean water and soap
2. Cleanse the injured part thoroughly, using plain soap and boiled water which is cooled at room temperature or clean with running water and soap
3. Apply a dry sterile or dry clean material and bandage it.

4. Tell the patient to go to the clinic or hospital if evidence of infection appears.

## **II. For wounds in which hemorrhage is sever**

1. Direct pressure should be applied over the wound with thick pad or clean cloth. In an emergency situation a piece of clothing or even bare hands will be used. After the bleeding has been controlled apply additional layer of cloth and in the mean time elevated the bleeding part of limbs.

**N.B.** Do not remove any layers of cloth that is already found on the wound since it may cause bleeding of the part.

2. Pressure will be apply to supplying vessel, for especial quick action, here you can use your fingers or the palm of your hands to press the supply vessels and then after bleeding is stop dress the wound and based on the severity refer him or her to the clinic.

## **III. Infected wound**

The patient with an infected wound should always be under the care of a hospital or health centre so, the health worker has to soaked the foot or the hand in solution of 2 table spoons of salt in to one liter of boiled waters for 15-20 minute, this can help to localized the infection.

**N.B.** In any case the health worker should not forget to send or refer the Victim and clinic for assessment and treatment of tetanus.

### **7.8.1 Tropical ulcer**

Tropical ulcers commonly develop at the site of an injury of abrasion and usually occur on lower extremities

#### **1. Causative organism**

- Treponema Vincent
- Bacillus fusiformes

Transmission – By direct contact and flies

## 2. Clinical picture

- The ulcer become large quickly as the skin and subcutaneous tissue involved
- The skin around the edge of the ulcer is hard, hot and tender to touch

## 3. Complication

The ulcer may become very deep down to the bone and osteomyelitis may develop.

## 4. Management

- The goal of the management is to give an emphasis to control the infection and promote healing of the ulcer
- Bed rest to enhance wound healing
- Encourage the patient to take a good nutrition like vitamin and protein (good diet)
- Clean the skin with soap solution and cover it with clean cloth
- Refer the patient to nearest clinic or Health centre

## 5. Prevention

- Since the disease appeared as result of malnutrition and poor personal hygiene the health worker has to teach community the importance of personal hygiene and nutrition.
- Give health education about maintaining of the wound cleanness and the need of treatment.

### 7.8.2 Bedsore

It is a special type of ulcer caused by impaired blood supply and tissue nutrition resulting from prolonged pressure over bony prominences. The most common areas are sacrum and hip but also include occipital area, elbow, heels, ankles, scapula and back.

#### 1. Predisposing factors

- Immobility (sleeping on one place for long hours) due to chronic debilitating disease
- Being incontinence (un able to control urine and feces)

- Edema (swelling of body) cause by impaired circulation

## **2. Clinical Manifestation**

At early time, the health workers notice that, there is redness, tissue swelling and congestion with a patient complaining discomfort, elevation of skin temperature because of high vasodilatation and then the part of skin progress to dusky, cyanotic blue gray appearance.

## **3. The goal of management of bed sore**

- Include relief of pressure, improve mobility, and improve nutritional status.

## **4. Management**

1. Relieving pressure
  - By frequent change position by using a variety of pads and supportive device to prominent areas
2. Improve mobility
  - Encourage passive and active exercise to increase blood circulation
3. Improve nutritional status
  - Tell the patient to take high protein, iron and vitamin
4. Reduce friction
  - Make the bed daily and as needed
5. Minimize moisture (keep the area clean and dry)
  - Soiled skin should be washed with soap & water and dry with sunlight
6. Apply dressing for already wounded skin cleaning are with warm water and soap
7. Maintain skin integrity by offering bed bath
8. Teach the family about frequent position and keeping body hygiene and important of nutrition.

## **7.9. Fungal Skin Diseases**

Fungus infection is a type of skin disease of the body and which would be caused by organism called fungus.

There are many kinds of fungi. Only a small number cause a disease. Some of the fungi attack only the skin, but others may attack any part of the body. Fungus infections

usually develop slowly. They may be superficial or deep. The fungus grows and multiplies in the skin, mucous membrane and hair, which is on the head, foot and body.

### **Transmission**

It can be transmitted directly or indirectly from man to man through skin contact of infected person or sharing of clothes with an infected person.

#### **7.9.1 Ring worm of the scalp (Tinea capitis)**

It is contagious fungal infection of the hair and usually occurs in children.

##### **1. Clinical manifestation**

- Clinically there is one or several round patches of redness & scaling which are small pustules or papules seen at the edges of such patches and cause the hair to break off and fall out
- In some untreated cases, it can be associated with infection.

##### **2. Management**

1. Use white field, if it is available
2. Keep the head clean
3. Refer the patient
4. Advise the patient not to share towels or combs

#### **7.9.2. Ring worms of feet (Athletes foot)**

The fungus grows on the sole of the feet and between the toes.

In acute stage there will be red weeping vesicles that can be accompanied with itching and burning sensation.

##### **1. Management**

- Keep the cleanliness of the foot
- Remove dead tissues and dry well between the toes
- Advise the person to wear light or open feet wear
- Apply dusting powders on the foot if it is available
- Use white field ointment or 1% clotrimazole cream (daily application for 4-8 weeks).
- Advise the patient to clean shoes, iron or boil soaks

**N.B.** Teach the patient and family about disease condition and at the same time follow the response of your treatment, if not refer, the patient to nearest health facility.

Advise the patient not to share shoes, soaks or towels with other healthy family members.

### **7.9.3. Candidiasis**

Candidiasis is a fungal infection of mouth, throat, intestine and vagina and often appears on the area of body that is moist and warm.

Candidiasis is also seen prior to manifestation of HIV AIDS.

#### **1. Classification of disease**

1. Vulvo vaginal candidiasis
2. Oral candidiasis (oral thrush)

#### **2. Mode of transmission**

Candida is a normal flora of the skin and grows and causes skin and mucous membrane lesions in diabetic, obesity, long term antibiotic therapy or immunosuppressive therapy or HIV/AIDS.

#### **3. Clinical manifestation**

White plaque patches at oral and pharyngeal mucosa around mouth and tongue. The lesions are usually painless but if the lesion is occur around the corner of mouth it will associate with pain.

#### **Management**

1. As long as the lesion is present  
Keep the mouth clean by using salt solution (always in between, before and after taking of meal)
2. Use gentian violet to paint on the lesion part
3. Encourage the patient to take fluid
4. Reassure the patient by telling the fact about the diseases
5. Refer the patient to the nearest health institution for further treatment

## **7.10. Viral Skin infections**

### **7.10.1. Chicken Pox (Varicella)**

It is infectious disease caused by human herpes virus called varcella zoster

#### **1. Transmission**

Chicken pox is spread by inhalation of infective droplets nuclei or contact with lesions of an infected person.

**2. Incubation period** 10-20 days

#### **3. Clinical manifestation**

- Mild headache, fevers and tiredness
- There is skin rash which are macula to papules and then vesicles
- Vesicles and some pustules remain for 3 to 4 days and then form crust over it and fall off without leaving scar
- The lesion commonly seen on the trunk of the body
- In some cases the lesion has itching and develops scar when the patient is scratched.

#### **4. Management**

There is no such curative treatment but

- Advise the patient to get bed rest until the fever subsides
- Encourage the patient to get force fluid (nutrient)
- Wash the skin with soap and water
- Give anti pain and anti fever medication like paracetamol, according to the age of patients
- Provide skin care daily.
- Keep finger nails short, avoid scratching the lesion as it may cause scarring
- Refer the patient to a hospital, if the patient develops any complication of the disease like pneumonia.

### **7.10.2. Herpes zoster**

This is an inflammatory viral condition of the skin, caused by varicella zoster virus, which is common in immunocompromised patients.

#### **1. Mode of transmission**

Contact with mucosal surface of infected person or abraded skin of infected person.



## **2. Clinical manifestation**

- Pain usually precedes the eruption by 48 hrs and may persist and actually increase in intensity after the lesion disappeared
- The lesions consist of grouped vesicles distributed unilaterally along the neural pathways of trunk.

## **3. Management**

1. Try to reduce pain, by diverting his attention the attention of patient and by giving analgesics.
2. Keep the skin clean
3. Encourage the patient to take nutrient
4. Reassure the patient
5. Refer the patient to nearest health center if necessary

### **7.10.3. Herpes simplex**

It is a viral disease of human being caused by herpes virus.

Clinically it classified in to two

Type 1 Herpes virus ( Herpes Oralis)

Type 2 Herpes virus (Herpes genitaly)

#### **1. Mode of transmission**

Type 1 herpes virus will be transmitted through contact with skin lesion of infected person whereas Type 2 herpes virus mostly transmitted to healthy person through sexual contact with an infected person.

#### **2. Clinical manifestation of herpes gingivo stomatitis**

- Lesion that is vesicular around mucous membrane of an oropharynx and changed to sore.
- Mild symptom like fever, muscle ache following lesion.
- Unable to eat as a result of lesion, especially in children.
- Pain on the part of lesion.

### 3. Management

- Give mouth care by using salt solution.
- Encourage the patient to take nutrient as the form of fluid.
- Give anti pain.
- Based on the severity Refer the patient to the nearest health institution.

## 7.11. Parasitic Skin infections

### 7.11.1 Scabies

It is common parasitic disease of skin, which will be cause by mite, known as sarcoptes scabiei.

#### 1. Mode of transmission

By direct skin to skin contact with an infected person and sharing of clothes and bedding with an infected person.

#### 2. Incubation period

Three to four weeks after exposure to an infected person. The adult female mite burrows into the superficial layer of the skin and start to lay an eggs daily for up to 2 months and she will die and the egg will hatch in 3 to 4 days and being develop adult mites with in 10 days.

#### 3. Clinical Picture

- Seeing the raised area where the mite burrows.
- There is much itching especially at night.
- As the result of penetration of mite there is visible papule or vesicle lesion around the fingers webs, anterior surface wrist, elbow, breasts, waist and buttocks.
- Through scratching there will be infection that are manifested by pus formation on the area.

#### 4. Management

- Cut fingernails short.
- Apply benzyl benzoate lotion every day at nighttime for 3 days.

- Tell the patient to take warm, soapy bath or shower to remove the scaling debris or crust, before treatment and after treatment.
- Use clean clothing and bedclothes. The dirty cloth should be boiled, washed in disinfectant and dried in the sun and if it is possible iron it.
- If secondary infection present refer the patient.
- Sulfur ointment may be used, if benzyl benzoate is not available.
- Treat all family members

## **7.12. Brief summary of Prevention and control of common Skin infections**

### **The Skin and Infections Associated With It**

Skin diseases are common throughout Africa and are dominated by bacterial and superficial fungal infections. The eczemas are ubiquitous. In some areas discoid lupus erythematosus is common and lichen planus is seen far more frequently than in temperate countries. Then there are the more chronic infections. These are: Leprosy, Leishmaniasis, Scabies and Onchocerciasis, which affect the skin so distinctively; the whole range of ulcers of the skin; and the serious effects on the skin of protein malnutrition. Therefore this particular chapter concentrates on the general preventive and control methods of skin infections that are important to be implemented by the health extension package workers.

#### **7.12.1. Prevention and control of Bacterial skin diseases**

Personal hygiene is the most effective method for prevention and control of bacterial infections. The following points illustrate the possible preventive methods for bacterial skin infections:

- ↻ Washing of hands with warm water and soap before touching broken skin.
- ↻ Washing the body with warm water and soap preferably everyday to remove dust and dirt.
- ↻ Wearing the right size and type of clothes to suit local weather conditions.
- ↻ After washing clothes, if possible, iron it before wearing
- ↻ Regular exposure of the skin to air and sunlight is beneficial.

- ↳ It is also important to clear the bacteria colonizing the nostrils and under the fingernails with either antibiotic ointment or petroleum jelly several times daily for one week of each month.

### **7.12.2. Personal Hygiene**

Many health problems are due to poor hygiene behavior. The benefits of safe water supply and sanitation efforts in a given community can easily be lost if the communities still carry on with the poor personal hygiene behavior. Health related programs, therefore, should consider carefully the changes in hygiene practices needed to complement improved water and sanitation facilities. To achieve these goals, hygiene education plays a central role and has to be applied on sustainable way. For detailed explanation on personal hygiene the reader is advised to refer the lecture notes on personal hygiene prepared by the carter centre for Ethiopian Health centre team.

#### **Tips on personal hygiene for every day items**

Here are some important points that the health extension worker needs to consider in addressing the promotion of personal hygiene, which is important in the prevention, and control of common skin infections:

- Wash your body with warm water and soap preferably every day to remove dust and dirt
- After showering or bathing ensure dry yourself thoroughly. Take special care to dry yourself between your toes, under your armpits and in the groin region.
- Regular exposure of the skin to air and sunlight is beneficial
- After bowel action, ensure the anal area is cleansed from the front backwards and not in the reverse direction. This reduces the chance of infections being passed to an individual's sexual organs.
- Wear the right size and type of clothes to suit local weather wearing
- Change your clothes, especially underwear, socks, stocking or tights on a regular basis- preferably daily
- Launder towels, washcloths, sheets, pillowcases, duvet covers, and bedclothes on a frequent and regular basis.
- After washing, hang clothes and if possible, iron it before wearing

- Do not share wash cloths or towels
- Do not share brushes, combs, toothbrushes or toilet articles
- Keep washbasins, toilet seats, bathrooms, kitchens and fixtures thoroughly clean.
- Use disposable tissues instead of handkerchiefs
- Use paper towels or tissues in the kitchen
- Items which can not be washed such as mattresses, thick rugs pillows should be given an outdoor airing in bright sunlight when possible
- Air your living accommodation for several hours on a dry sunny day.

#### **7.12.4. Leprosy**

Leprosy is caused by mycobacterium leprae. Mycobacterium leprae is probably as communicable as M. tuberculosis. However, the portal of entry, method of spread, genesis of lesions, and manner of dissemination are still unclear.

##### **7.12.4.1 Prevention and control measures**

###### **1. Case detection and treatment**

Multidrug therapy (MDT) rapidly reduces the infectivity of patients, but it has not yet demonstrated that it is able to prevent new cases occurring in the community.

###### **2. Prevention of disability and rehabilitation**

Activities aimed at preventing impairment and disability in leprosy patients are important and depend on a good relationship between health worker and patient.

In order to prevent disability, early detection of cases is a high priority. However, early detection and treatment with MDT will not prevent all nerve function impairment. Therefore, patients should be regularly examined, so that reactions and new nerve function impairment can be detected and treated appropriately.

#### **7.12.5. Prevention and control of fungal infections**

Normal skin is impenetrable to microorganisms. However, some microbes have developed the ability to destroy the upper layer of the skin to enable their colonization. Among the various infections of skin, infections caused by fungi (mycoses) pose a

major challenge. Warmth, humidity, sweating, over crowding and poor air circulation all help bring about these fungal infections.

Because of all these factors, prevention is a matter of both personal hygiene and minimizing contact with potential carriers or contaminated objects see the chart below for guidelines on prevention.

### **Preventing skin fungus infections**

#### **Personal Hygiene**

- ☞ Use anti-perspirants and talcum powder to keep high-risk areas dry
- ☞ If you're susceptible to athlete's foot, use an anti-fungal powder and anti-fungal socks
- ☞ In high humidity, keep clothing loose and light; avoid knits and less breathable synthetic materials

#### **Avoidance**

- ☞ Don't share towels or clothes
- ☞ Wear thongs or other foot wear in public locker rooms, pools, and showers
- ☞ Always wear a thick T-shirt or sweat shirt and long shorts or sweat pants while sharing exercise equipment.
- ☞ Wipe off vinyl surfaces with a dry towel before using exercise equipment.

### **7.12.6. Prevention and control of Viral skin infection**

1. Early detection and treatment
2. Enforcing the practice of good personal hygiene, such as regular bathing, laundering clothes, not sharing towels, soaps and wearing sandals in communal showers.
3. Avoid contact with vesicles.
4. Herpes lesions must be completely dry and crusted and should be covered until completely resolved.
5. Cover all warts until completely resolved.
6. Care providers should wear gloves.
7. Educating the people about prevention strategies is an important task.

8. Warm showers are recommended in herpes simplex I in order to cleanse the infected area. Afterwards, towel dry gently, or dry the area with a hair dryer on a low or cool setting.

#### **7.12.7. Arthropods and skin disease**

Arthropods have been associated with human beings since the age of antiquity. Although arthropods are important in maintaining the ecosystem we live in, they can adversely affect our health in several ways:

- ↪ By causing direct, non-allergic, local tissue damage through stings, bites, exposure of toxic body fluid (blister beetles), and tissue invasion (sand flea and brown recluse spider).
- ↪ By causing allergic reactions to their secretions, skins, or scales.
- ↪ By producing systemic toxicity, such as that caused by neurotoxin release (black widow spider and scorpions).
- ↪ By transmitting diseases.

##### **7.12.7.1 Scabies**

Scabies is one of such arthropod associated diseases by the mite, *Sarcoptes scabiei var hominis*, and characterized by marked itching.

Scabies is a contagious complaint, which is transmitted only by close contact. It is therefore a family disease spreading amongst those living in close association, especially when they sleep together in the same bed.

##### **7.12.7.2 Prevention and control of scabies**

All cases of scabies can be cured; there are no resistant infections. Methods aimed at killing the mites will do little to immediately alleviate the nuisance and irritation caused by the rash, although this will eventually disappear. Separate medical treatment however, may be necessary especially if secondary infections have become established. In the past, a common procedure was to give the patient a hot bath and a vigorous scrubbing with a brush until the patient bled, but this is not very effective at either removing or killing the mites. However, as many but certainly not all, patients with

scabies are dirty, an ordinary bath before treatment may be advisable for general hygienic reasons. However, if large numbers of patients suffering from scabies are to be treated, such as in epidemic situations, bathing may not be practical.

Decreasing the humidity in rooms, improving ventilation and removing dust can control mites and associated fungi. Bedrooms and living rooms should be aired regularly, or other measures should be taken to reduce dampness. The shaking of bedclothes and frequent washing of sheets and blankets reduces the availability of food and therefore the number of mites. Vacuum cleaning of beds, carpets and furniture is also effective. General insecticides used for pest control are not effective but a special product containing benzyl benzoate is available, which destroys mites when applied to mattresses, and upholstery.

#### **7.12.8 Leishmaniasis**

Leishmaniasis is a term used to describe a number of closely related diseases caused by several distinct species, subspecies and strains of leishmania parasites.

##### **Cutaneous Leishmaniasis**

Known under a variety of common names, such as oriental sore in old world, uta or chiclero ulcer in new world.

It is caused by leishmania major, leishmania tropica and leishmania aethiopica in old world and by leishmania braziliensis, leishmania mexicana and leishmania peruana in new world.

It is characterized by typical ulcer that starts as a nodule at the site of bite, and then a crust develops in the middle which exposes the ulcer.

##### **7.12.8.1. Prevention and control of leishmaniasis**

###### **1. Personal protection**

Individuals can prevent infection by avoiding being bitten by sand flies. It is recommended that personal protection measures be taken, such as repellents, fine mesh screens, insecticide treated clothing and/ or insecticide treated bed nets are used.



## **2. Application of insecticides**

- Spraying the interior surfaces of houses with residual insecticides, such as DDT, Malathion, propoxur, etc.
- If out door resting sites are known they can be sprayed with residual insecticides.

## **3. Application of basic sanitation**

This is aimed at abolishing the breeding sites around human habitation, such as proper disposal of refuse; filling of cracks and holes in the soils and walls.

## **4. Control of Animal Reservoir**

In Ethiopia, control measures were carried out against the rock hyrax, a wild animal reservoir of leishmaniasis, where by reduction of the prevalence of leishmaniasis was occurred. Similarly control measures can be taken against foxes and dogs.

### **7.12.9. Prevention and control of Atopic dermatitis**

1. Case treatment: Treatment is more effective when a partnership develops that includes the patient, family members and doctor.
2. Prevent scratching or rubbing whenever possible.
3. Protect skin from excessive moisture, irritants, and rough clothing.
4. Maintain a cool, stable temperature and consistent humidity levels.
5. Limit exposure to dust, cigarette smoke, pollens, and animal danger.
6. Recognize and limit emotional stress.

# UNIT EIGHT

## ANNEXES

### 8.1 diagnostic guides

#### Skin problems

Some skin problems are caused by diseases or irritations that affect the skin only such as ringworm, diaper rash, or warts. Other skin problems are signs of diseases that affect the whole body such as the rash of measles or the sore, dry patches of pellagra (malnutrition). Certain kinds of sores or skin conditions may be signs of serious diseases—like tuberculosis, syphilis, or leprosy.

This chapter deals only with the more common skin problems in rural areas. However, there are hundreds of diseases of the skin. Some look so much alike that they are hard to tell apart—yet their causes and the specific treatments they require may be quite different.

**If a skin problem is serious or gets worse in spite of treatment, seek medical help.**

### GENERAL RULES FOR TREATING SKIN PROBLEMS

Although many skin problems need specific treatment, there are a few general measures that often help:

#### RULE #1

If the affected area is **hot** and painful, or oozes pus, treat it with **heat**. Put hot, moist cloths on it (*hot compresses*).

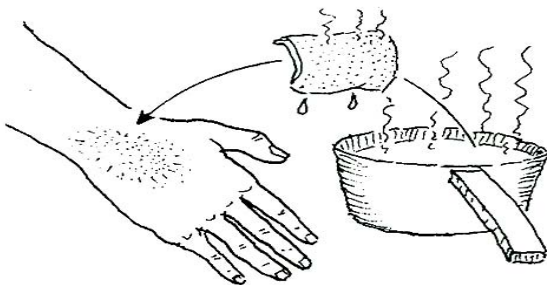





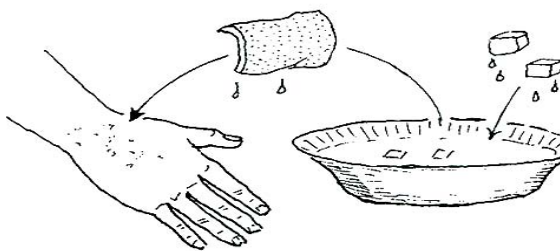









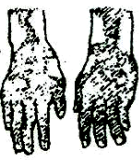

#### RULE #2

If the affected area itches, stings, or oozes clear fluid, treat it with **cold**. Put cool, wet cloths on it (*cold compresses*).



## A Guide to Identification

IF THE SKIN HAS:	AND LOOKS LIKE:	YOU MAY HAVE:	SEE PAGE:
swollen lymph nodes 	Nodes on the side of the neck that continuously break open and scar. 	scrofula (a type of tuberculosis)	211
	Nodes in the groin that continuously break open and scar. 	venereal lymphogranuloma chancroid	283
large spots or patches 	Dark patches on the forehead and cheeks of pregnant women. 	mask of pregnancy	244
dark 	Scaly, cracking areas that look like sunburn on the arms, legs, neck, or face. 	pellagra (a type of malnutrition)	245
	Dark, painless patches on the skin or mouth that start small and grow. 	Karposi's Sarcoma (KS, cancer related to the HIV/AIDS virus).	285-288
	Purple spots or peeling sores on children with swollen feet. 	malnutrition	245
white 	Round or irregular patches on the face or body, especially of children. 	tinea versicolor (fungus infection)	243
	White patches, especially on hands, feet, or lips 	that begin with reddish or bluish pimples. pinta (infection)	244
	that begin without other signs. vitiligo (loss of color, nothing more)		243
reddish 	Reddish or blistering patches on the cheeks or behind the knees and elbows of young children. 	eczema	253
	A reddish, hot, painful patch that spreads rapidly. 	erysipelas (cellulitis or very serious bacterial infections)	249
	A reddish area between the baby's legs. 	diaper rash from urine or heat	252
	Beef-red patches with white, milky curds in the skin folds. 	moniliasis (yeast infection)	270
reddish or gray	Raised reddish or gray patches with silvery scales; especially on elbows and knees; chronic (long-term) 	psoriasis (or sometimes tuberculosis)	253

- Another way of applying lindane is to put 4 drops on half a lemon. Leave for 5 minutes and then rub the lemon over the whole body, except the face.

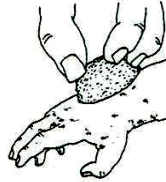
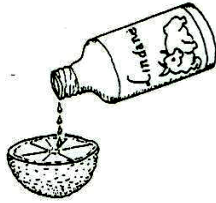

- Monosulfiram as **Tetmosol soap** (p.425). Apply this like benzyl benzoate, allowing the lather to dry on. Wash off the next day and repeat once or twice. Subsequently use the soap for family washing in the ordinary way.
- Sulfur (p.425) may be made into an ointment with lard, or mixed with body oil, and used for several days. It does work, but much more slowly.

## LICE

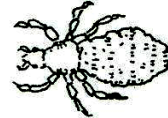

Head lice and body lice cause itching, and sometimes skin infections and swollen lymph nodes. To avoid lice, take great care with personal cleanliness. Put cots, pillows, and bedding in the sun every day. Bathe and wash hair often. Check children's hair. If they have lice, treat them at once. Do not let a child with lice sleep with others.

Lice transmit relapsing fever and typhus, both of which are common in Ethiopia.

### Treatment:

- Wash the hair well. Apply permethrin lotion (p.425). Leave for 10 minutes then rinse off.
- As an alternative, make a shampoo of lindane (p.425), water and soap (1 part lindane to 10 parts water). Wash hair, being careful not to get lindane in the eyes. Leave the lather for 15 minutes, then rinse well with clean water. Repeat a week later.
- To get rid of nits (lice eggs), soak hair with hot vinegar water for half an hour, then comb it thoroughly with a fine-toothed comb.



## BEDBUGS

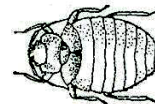

These are very small flat, crawling insects that hide inside mattresses, bedding, furniture, and walls. They usually bite at night. The bites often appear in groups or lines.

To get rid of bedbugs, wash bedding and pour boiling water on cots and bed frames. Sprinkle sulfur on mattresses, cloth furniture, and rugs and do not use them for 3 weeks. Be sure to clean off the powder well before using again.

To prevent bedbugs, spread bedding, mats and cots in the sun often.

## TICKS

When removing a tick that is firmly attached, take care that its mouth parts do not break off and remain under the skin, since this can cause an infection. Never pull on the body of a tick. To make it let go:

- put some alcohol on it, or
- hold a lit cigarette near it

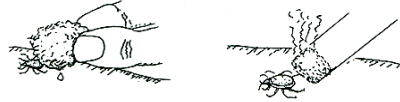

To help prevent ticks from biting you, dust sulfur powder on your body before going into the fields. Especially dust ankles, wrists, waist, and underarms.

## JIGGERS

People who walk barefoot on sandy soil may get jiggers in their toes. These are caused by a small flea that burrows under the skin to lay its eggs. A small, white, very itchy swelling grows there.

Treat by using a sterile needle to remove the flea whole. If the flea is broken and the eggs are released, they may hatch and cause more serious problems.

## TUMBU FLY

This fly, something like a housefly, may lay its eggs on the skin of a child, often on the scalp. The grub that hatches from the egg burrows under the skin and grows, causing a swelling like a boil (p.239). Where the 'boil' points, the grub's mouth-parts, through which it breathes, can be seen moving.

Treatment is simple. Apply **Vaseline** to the top of the swelling. The grub cannot breathe and has to come out. Clean the sore and apply a dab of gentian violet.

## SMALL SORES WITH PUS

Skin infections in the form of small sores with pus often result from scratching insect bites, scabies, or other irritations with dirty fingernails.

### **Treatment and prevention:**

- ◆ Wash the sores well with soap and boiled water, gently soaking off the scabs. Do this daily as long as there is pus.
- ◆ Leave small sores open to the air. Bandage large sores and change the bandage frequently.
- ◆ If the skin around a sore is swollen and hot, or if the person has a fever or tender, enlarged lymph nodes, use an antibiotic—such as penicillin tablets (p.402) or sulfa tablets (p.409).
- ◆ Do not scratch sores. This makes them worse and can spread infection to other parts of the body. Cut the fingernails of small children very short or put gloves or socks over their hands so they cannot scratch.
- ◆ Never let a child with sores or any skin infection play or sleep with other children. These infections are easily spread.



## ITCHING RASH, HIVES OR URTICARIA (ALLERGIC REACTIONS IN THE SKIN)

Touching, eating, injecting, or breathing certain things can cause an itching rash or hives in allergic persons. For more details, see allergic reactions, page 193.

Hives are thick, raised spots or patches that look like bee stings and itch like mad. They may come and go rapidly or move from one spot to another.

Be on the watch for any reaction caused by certain medicines, especially injections of penicillin and the antivenoms or antitoxins made from horse serum. A rash or hives may appear from a few minutes up to 10 days after the medicine has been injected.



**If you get an itching rash, hives, or any other allergic reaction after taking or being injected with any medicine, stop using it and never use that medicine again in your life!**

This is very important to prevent the danger of ALLERGIC SHOCK (see p.78).

### ***Treatment of itching:***

- ◆ Bathe in cool water or use cool compresses (cloths soaked in cold water or ice water).
- ◆ Compresses of cool oatmeal water also calm itching. Boil the oatmeal in water, strain it, and use the water when cool. (Starch can be used instead of oats.)
- ◆ If itching is severe, take an antihistamine like chlorpheniramine (p.440).

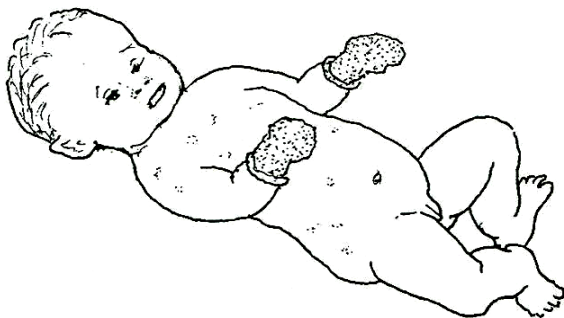

- ◆ To protect a baby from scratching himself, cut his fingernails very short, or put gloves or socks over his hands.

## PLANTS AND OTHER THINGS THAT CAUSE ITCHING OR BURNING OF THE SKIN

Nettles, 'stinging trees', sumac, 'poison ivy', and many other plants may cause blisters, burns, or hives with itching when they touch the skin. Juices or hairs of certain caterpillars and other insects produce similar reactions.

In allergic persons rashes or 'weeping' sore patches may be caused by certain things that touch or are put on the skin. Rubber shoes, watchbands, ear drops and other medicines, face creams, perfumes, or soaps may cause such problems.



### **Treatment:**

All these irritations go away by themselves when the things that cause them no longer touch the skin. A paste of oatmeal and water helps calm the itching. Aspirin or antihistamines (p.440) may also help. In severe cases, you can use a cream that contains cortisone or a cortico-steroid (see p.423).

## SHINGLES (HERPES ZOSTER)

### **Signs:**

A line or patch of painful blisters that appears all of a sudden on one side of the body is probably shingles. It is most common on the back, chest, neck, or face. The blisters usually last 2 or 3 weeks, then go away by themselves. Sometimes the pain continues or returns long after the blisters are gone.

Shingles is caused by the virus that causes chickenpox and usually affects persons who have had chickenpox before. It is not dangerous. (However, it may be a warning sign of some other more serious problem, perhaps cancer or AIDS.)

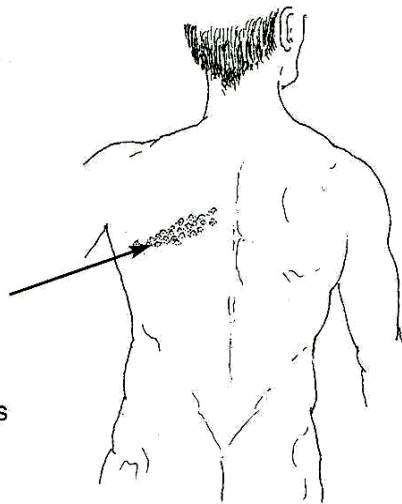

### **Treatment :**

- ◆ Put light bandages over the rash so that clothes do not rub against it.
- ◆ Take aspirin or panadol for the pain. (Antibiotics do not help.)

## RINGWORM, TINEA (FUNGUS INFECTIONS)

Fungus infections may appear on any part of the body, but occur most frequently on:

the scalp  
(tinea)

the parts without  
hair (ringworm)

between the  
toes or fingers  
(athlete's foot)

between the legs  
(jock itch)

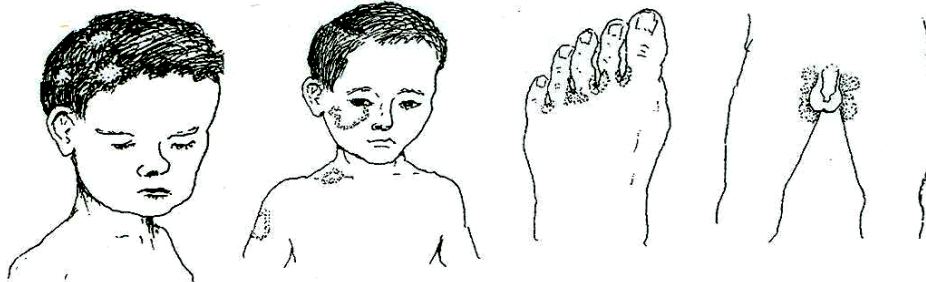

Most fungus infections grow in the form of a ring. They often itch. Ringworm of the head can produce round, white patches with scales and loss of hair. Fingernails infected with the fungus become rough and thick.

### **Treatment:**

- ◆ Soap and water. Washing the infected part every day with soap and water may be all that is needed.
- ◆ Do your best to keep the affected areas dry and exposed to the air or sunlight. Change underwear or socks often, especially when sweaty.
- ◆ Use a cream of sulfur and lard (1 part sulfur to 10 parts lard).
- ◆ Creams with salicylic or undecylenic acid (p.424) help cure the fungus between the fingers, toes, and groin. Miconazole cream, if available, is even more effective (p.425).
- ◆ For severe tinea of the scalp, or any fungus infection that is widespread or does not get better with the above treatments, take griseofulvin, 1 gram a day for adults and half a gram a day for children (p.424). It may be necessary to keep taking it for weeks or even months to completely control the infection.
- ◆ Many tinea of the scalp clear up when a child reaches puberty (11 to 14 years old). Severe infections forming large swollen patches with pus should be treated with compresses of warm water (p.232). It is important to pull out all of the hair from the infected part. Use griseofulvin, if possible.





### **How to prevent fungal infections:**

Ringworm and all other fungal infections are **contagious** (easily spread). To prevent spreading them from one child to others:

- ◆ Do not let a child with a fungal infection sleep with the others.
- ◆ Do not let different children use the same comb or use each other's clothing unless these are washed or well cleaned first.
- ◆ Treat an infected child at once.

## **WHITE SPOTS ON THE FACE AND BODY**

Small lighter spots or areas, with a distinct and irregular border, that are often seen on the neck, chest, and back may be a fungal infection called **tinea versicolor**. It usually does not itch and is of little medical importance.



### **Treatment:**

- ◆ Make a cream with sulfur and lard (1 part sulfur to 10 parts lard) and apply it to the spots every day until they disappear.
- ◆ Sodium thiosulfate works even better. This is the 'hypo' photographers use when developing film. Dissolve a tablespoon of sodium thiosulfate in a glass of water, apply it to the skin and then rub the skin with a piece of cotton dipped in vinegar.
- ◆ To prevent the spots from returning, it is often necessary to repeat this treatment every 2 weeks.
- ◆ Selenium sulfide (p.424) or Whitfield's ointment may help.



A patch of tinea versicolor on the cheek or neck of a child may be very hard to distinguish from the earliest signs of leprosy (Hansen's disease). If the above treatments do not seem to be effective, take the child for medical help to exclude this possibility. Leprosy takes many months or years to become more obvious (p.222).

## **Vitiligo (White Areas of the Skin)**

In some persons, certain areas of the skin lose their natural black color, and completely white patches occur. This happens most often around the mouth, or on the hands and feet, and around the anus or genitals. Be sure that the person understands that the color loss is **not** a sign of leprosy, or any other serious disease. It can be compared to white hair in older people. However, it can be very embarrassing to the person concerned, and cosmetic coloring of the skin may be advised if the trouble is on the face. There is no special treatment. In some cases the color returns by itself without treatment.

## Other Causes of White Skin Patches

Any patch of skin that is lighter or darker in color and that **has no feeling** when pricked with a pin is probably *leprosy* (see p.222).

Many *injuries*, specially burns, cause temporary loss of the surface of the skin, with its layer of dark color (pigment). When some deep scars heal there is no pigment in the scar tissue.

Infections, like *measles*, which lead to peeling of the skin, also give temporary pigment loss in the areas affected.

*Onchocerciasis*, in its later stages, may show patchy white areas on the front of the lower legs (shins), often called 'leopard-skin'. Patches of skin that look like orange peel may appear on the back.

## GENERAL, PARTIAL LOSS OF SKIN AND HAIR COLOR.

The commonest cause in children aged 9 months to 2 years is the kind of malnutrition known as *kwashiorkor* (p.129).

The other common cause is *tuberculosis* (p.210). If malnutrition and tuberculosis occur together the skin color loss may be even more marked. Get medical help.

Vitiligo

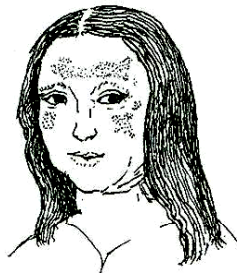
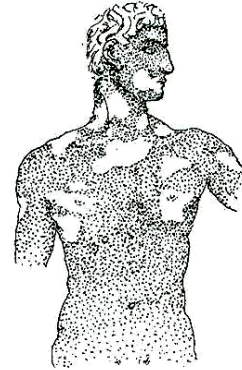
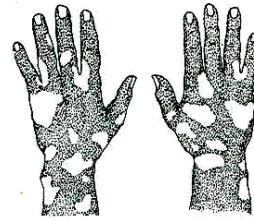

## MASK OF PREGNANCY

During pregnancy many women develop dark, olive-colored areas on the skin of the face, breasts, and down the middle of the belly. Sometimes these disappear after the birth and sometimes not. These marks also appear sometimes on women who are taking birth control pills.

They are completely normal and do not indicate weakness or sickness. No treatment is needed.

## Albinos

Some children are born without the normal coloring (pigment) in the skin, or hair, or in the iris of their eyes. In tropical climates this is a serious disability, as the person does not have the usual protection from the rays of the sun.

It is best for albinos to stay indoors, if possible, during broad daylight. If they go out they may need a wide-brimmed hat, dark glasses, and adequate clothing. The hair can be dyed black. If they take precautions, and their eyesight is satisfactory, they should be able to attend school and do well.



A 'bronze albino' is one born with light brown skin and hair. This is a variation from normal and causes no harm.

A health worker should be asked to check the skin of albino persons from time to time in case skin problems are giving trouble, or skin cancer is suspected. Special creams or 'sun-tan lotion' can now be obtained to protect exposed or affected parts of the skin.

## SKIN PROBLEMS DUE TO MALNUTRITION

**Pellagra** is a form of malnutrition that affects the skin and sometimes the digestive and nervous systems. It is very common in places where people eat a lot of maize (corn) or other starchy foods and not enough beans, meat, eggs, vegetables, and other body-building and protective foods (see p.126).

In adults with pellagra the skin is dry and cracked, it peels like sunburn on the parts where the sun hits it, especially:

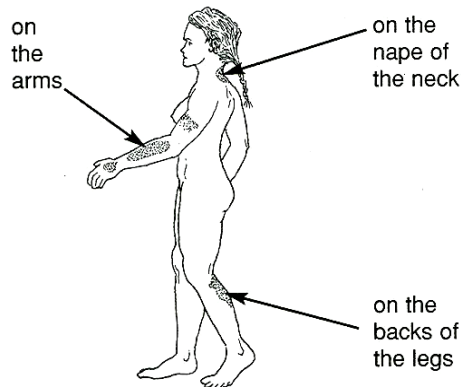

The 'burnt' skin on the legs of this woman is a typical sign of pellagra.

In children with **kwashiorkor** the skin of the legs (and sometimes arms) may have dark marks, like bruises, or even peeling sores; the feet may be swollen (see p.129).

When these conditions exist, often there are also other signs of malnutrition (some due to **shortage of vitamins**): sores in the corners of the mouth (see p.269); red, sore tongue; weakness; loss of appetite; failure to gain weight; swollen belly; etc. (see Chapter 11, p.123).

### **Treatment:**

- ◆ Eating nutritious foods cures pellagra. Every day a person should eat beans, lentils, groundnuts, or some chicken, fish, eggs, meat, or cheese. When you have a choice, it is also better to use wheat (preferably whole wheat) instead of maize (corn).
- ◆ For severe pellagra and some other forms of malnutrition, it may help to take vitamins, but **good food is more important**. Be sure the vitamin formula you use is high in the B vitamins, especially niacin. Brewer's yeast is a good source of B vitamins.

### Skin signs of kwashiorkor:

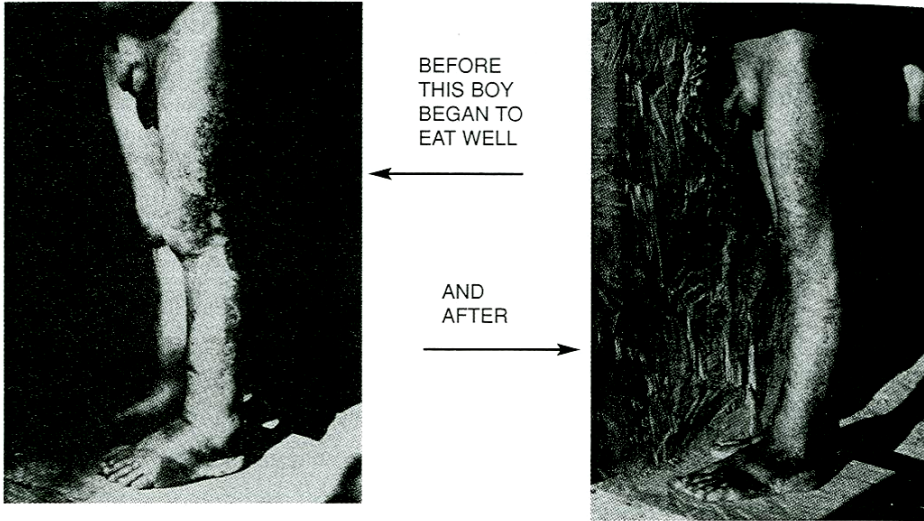

The swelling and dark spots on this boy's legs and feet are the result of poor nutrition. He was eating mostly maize (stored from the last harvest), without any foods rich in proteins and vitamins.

One week after he began to eat beans and eggs along with fresh maize, the swelling was gone and the spots had almost disappeared. See page 126 for more information on treatment.

### WARTS (VERRUCAE)

Most warts, especially those in children, last 3 to 5 years and go away by themselves. Flat, painful wart-like spots on the sole of the foot are often 'plantar warts'. (Or they may be corns. See below.)

#### **Treatment:**

- ◆ Magical or household cures often get rid of warts. But do not use strong acids or poisonous plants, as these may cause burns or sores much worse than the warts.
- ◆ Apply dophyllin or biochloracetic acid (p.426) for 3 or 4 days.
- ◆ Painful plantar warts sometimes can be removed by a health worker.
- ◆ For warts on the penis or vagina (see p.283).



## CORNS

A corn is a hard, thick part of the skin. It forms where sandals or shoes push against the skin, or one toe presses against another. Corns can be very painful.

### **Treatment:**

- ◆ Get sandals or shoes that do not press on the corns.
- ◆ To make corns hurt less, do this:

1. Soak the foot in warm water for 15 minutes.

2. With a file or rasp, trim down the corn until it is thin.



3. Pad the foot around the corn so that it will not press against the shoe or another toe. Wrap the foot or toe in a soft cloth to make a thick pad and cut a hole around the corn.

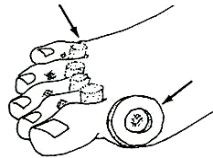

## AINHUM

This occurs mainly in farmers who walk barefoot. An abnormality of the blood supply to the small toes may lead to a gradually developing deformity. The toe becomes encircled by a band of scar tissue. Walking becomes very painful. After many months of pain the toe drops off. Both small toes may be affected. Medical help should be sought earlier for removal of the affected toe or toes. Immunization against tetanus is advisable first (p.170).



## KELOID

This is an overgrowth of scar tissue, and may occur when a wound has been chronically infected, e.g. after a girl's ear has been pierced for ear-rings, but without any aseptic precautions. The resulting keloid scar can be very disfiguring. If traditional healers attempt to remove the mass, it may result in an even bigger keloid. Get medical help, but be patient if a cure is not possible.

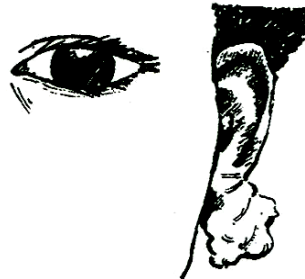

## TUBERCULOSIS OF THE SKIN OR LYMPH NODES

The same microbe that causes tuberculosis of the lungs may also have local effects upon the skin, causing painless:

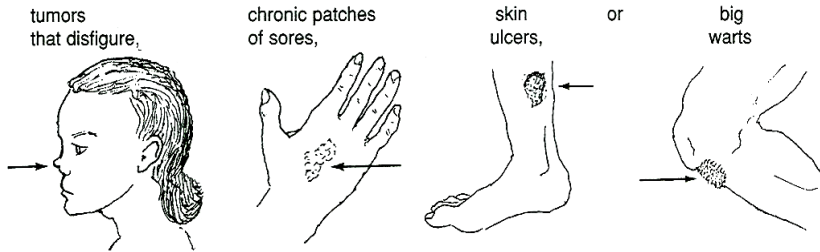

As a rule, TB of the skin develops slowly, lasts a long time, and keeps coming back over a period of months or years.

Also, tuberculosis sometimes infects the lymph nodes most often those of the neck or in the area behind the collar bone, between the neck and the shoulder. The nodes become large, open, drain pus, seal closed for a time, and then open and drain again. Usually **they are not painful**.

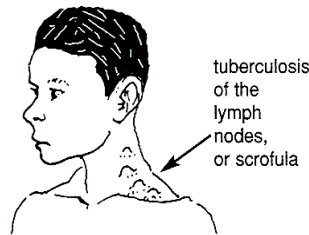

### **Treatment:**

In the case of any chronic sore, ulcer, or swollen lymph nodes, it is best to seek medical advice. Tests may be needed to learn the cause. Tuberculosis of the skin is treated the same as tuberculosis of the lungs (see p.211). To keep the infection from returning, the medicines must be taken for many months after the skin looks well.

## ERYSIPELAS AND CELLULITIS

**Erysipelas** (or St. Anthony's fire) is a very painful acute (sudden) infection in the skin. It forms a hot bright red, swollen patch with a sharp border. The patch spreads rapidly over the skin. It often begins on the face, at the edge of the nose. This usually causes swollen lymph nodes, fever and chills.



**Cellulitis** is also a very painful, acute infection of the skin that can appear anywhere on the body. It usually occurs after a break in the skin. The infection is deeper and the borders of the patch are less clear than with erysipelas.

### **Treatment:**

For both erysipelas and cellulitis, begin treatment as soon as possible. Use an antibiotic: penicillin tablets 400,000 units, 4 times a day; in serious cases, injectable procaine penicillin, 800,000 units daily (see p.404). Continue using the antibiotic for 2 days after all signs of infection are gone. Also use hot compresses and aspirin for pain.

## GANGRENE (GAS GANGRENE)

This is a very dangerous infection of a wound, in which a foul-smelling gray or brown liquid forms. The skin near the wound may have dark blisters and the flesh may have air bubbles in it. The infection begins between 6 hours and 3 days after the injury. It quickly gets worse and spreads fast. Without treatment it causes death in a few days.



### **Treatment:**

- ◆ Open up the wound as wide as possible. Wash it out with boiled water and soap. Clean out the dead and damaged flesh. If possible, flood the wound with hydrogen peroxide every 2 hours.
- ◆ Inject penicillin (crystalline if possible), 1,000,000 (a million) units every 3 hours.
- ◆ **Leave the wound uncovered so that air gets to it. Get medical help.**

## ULCERS OF THE SKIN CAUSED BY POOR CIRCULATION

Skin ulcers, or large, open sores, have many causes (see p.27). However, chronic ulcers on the ankles of older persons, especially in women with varicose veins, usually come from poor circulation. The blood is not moving fast enough through the legs. Such ulcers may become very large. The skin around the ulcer is dark blue, shiny, and very thin. Often the foot is swollen.



### **Treatment :**

- ◆ These ulcers heal very slowly and only if great care is taken. Most important: **keep the foot up** as high and as often as possible. Sleep with it on pillows. During the day, rest with the foot up high every 15 or 20 minutes. **Walking helps the circulation, but standing in one place and sitting with the feet down are harmful.**
- ◆ Put warm compresses of weak salt water on the ulcer 1 teaspoon salt to a liter of boiled water. Cover the ulcer loosely with sterile gauze or a clean cloth. **Keep it clean.** Honey may help (see p.252).
- ◆ Support the varicose veins with elastic stockings or bandages. Continue to use these and to keep the feet up after the ulcer heals. Take great care not to scratch or injure the delicate scar.

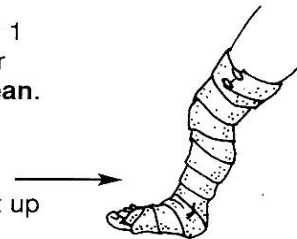
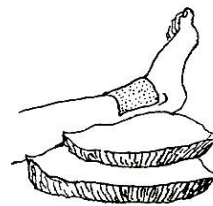

**Prevent skin ulcer—care for varicose veins early (see p.207).**

## BED SORES

These chronic open sores appear in persons so ill they cannot roll over in bed, especially in sick old persons who are very thin and, weak. The sores form over bony parts of the body where the skin is pressed against the bedding. They are most often seen on the buttocks, back, elbows, or feet.

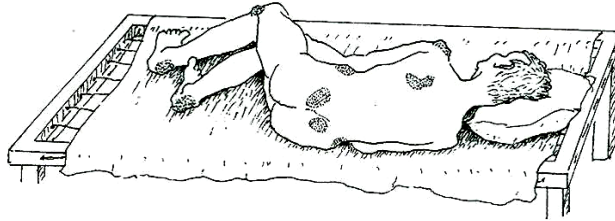

### ***How to prevent bed sores:***

- ◆ Turn the sick person over every hour: face up, face down, or from one side to the other.
- ◆ Bathe him every day and rub his skin with baby oil.
- ◆ Use soft bed sheets and padding. Change them daily and each time the bedding gets dirty with urine, stools, vomit, etc.
- ◆ Put cushions under the person in such a way that the bony parts rub less.
- ◆ Feed the sick person as well as possible. If he does not eat well, extra vitamins may help (see p.136).
- ◆ A child who has a severe chronic illness should be held often on his mother's lap.

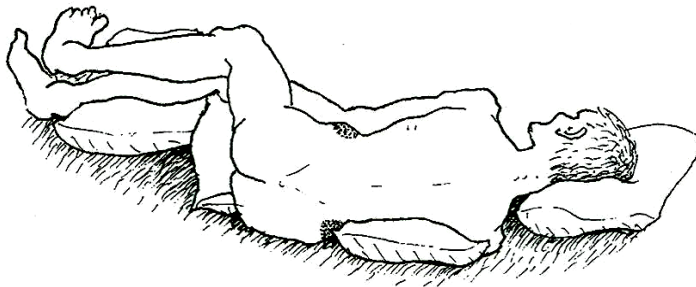

### ***Treatment:***

- ◆ Do all the things mentioned above.
- ◆ Wash the sores with boiled water mixed with a little salt or hydrogen peroxide. Protect them with sterile gauze bandages.
- ◆ To fight infection and speed healing, fill the sore with a paste made of honey and sugar, at least 2 times a day until clean.



## SKIN PROBLEMS OF BABIES

### Diaper Rash

Patches of irritation between a baby's legs or buttocks may be caused by urine in his diapers (nappy) or bedding.

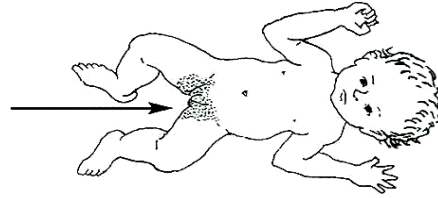

#### **Treatment:**

- ◆ Bathe the child daily with lukewarm water and mild soap.
- ◆ **To prevent or cure the rash, the child should be kept naked, without diapers, and he should be taken out into the sun.**

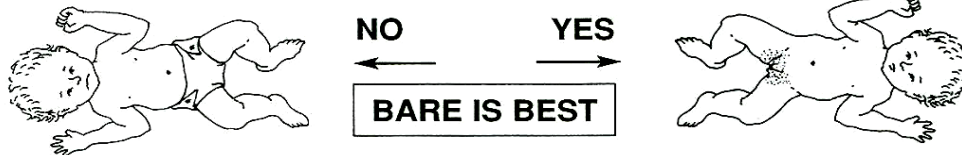

- ◆ If diapers are used, change them often. After washing the diapers, rinse them in water, with a little vinegar.
- ◆ Use talc (talcum powder) only after the rash has gone.

### Cradle Cap (Seborrhea, Dandruff)

Cradle cap is an oily, yellow crust that forms on a baby's scalp. The skin is often red and irritated. Cradle cap usually results from not washing the baby's head often enough, or from keeping the head covered.

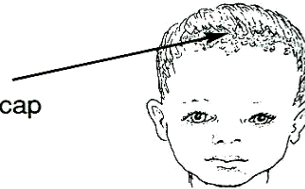

#### **Treatment:**

- ◆ Wash the head daily. If possible use a medicated soap (see p.423).
- ◆ Gently clean off all the dandruff and crust. To loosen the scales and crust, first wrap the head with towels soaked in lukewarm water.
- ◆ Keep the baby's head **uncovered**, open to the air and sunlight.

DO NOT COVER A  
BABY'S HEAD  
WITH A CAP OR  
CLOTH. KEEP  
THE HEAD  
UNCOVERED.



- ◆ If there are signs of infection, treat as for impetigo (see p.239).

## ECZEMA (RED PATCHES WITH LITTLE BLISTERS)

### Signs:

- Occasionally children have a tendency to get rashes, for example, on the cheeks or arms and hands. The rash consists of small sores or blisters that ooze or weep (burst and leak fluid).
- In older children and adults, eczema is, usually drier, and is most common on the backs of the hands or wrists, or the upper surface of the feet. It tends to occur on **both** hands or **both** feet, because its cause is not local, but due to a general body sensitivity.



### Treatment:

- ◆ Put cold compresses on the rash.
- ◆ If signs of infection develop (p.98), treat as for impetigo (p.239).
- ◆ Let the sunlight fall on the patches.
- ◆ In difficult cases, use a cortisone or cortico-steroid cream (see p.423). Get medical help.

## PSORIASIS

### Signs:







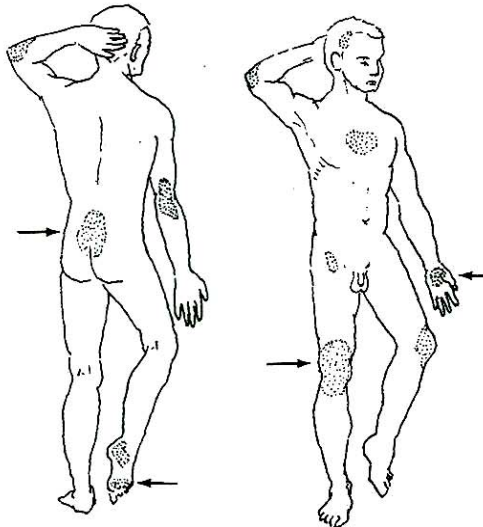



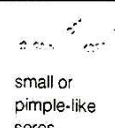

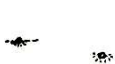









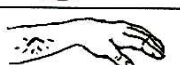

- Thick, rough patches of reddish or blue-gray skin covered with whitish or silver-colored scales. The patches appear most commonly in the parts shown in the drawings.
- The condition usually lasts a long time or keeps coming back. It is not an infection and is not dangerous.

### Treatment:

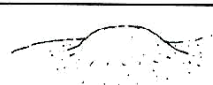
- ◆ Leaving the affected skin open to the sunlight often helps.
- ◆ Bathing in the ocean sometimes helps.
- ◆ Seek medical advice. Treatment must be continued for a long time.



## SKIN PROBLEMS—A Guide to Identification

IF THE SKIN HAS:	AND LOOKS LIKE:	YOU MAY HAVE:	SEE PAGE:	
 <p>small or pimple-like sores</p>	<p>Tiny bumps or sores with much itching—first between fingers, on the wrists, or the waist.</p> 	scabies	236	
	<p>Pimples or sores with pus or inflammation, often from scratching insect bites. May cause swollen lymph nodes.</p> 	infection from bacteria	238	
	<p>Irregular, spreading sores with shiny, yellow crusts.</p> 	impetigo (bacterial infection)	239	
	<p>Pimples on young people's faces, sometimes chest and back, often with small heads of pus.</p> 	acne, pimples, blackheads	248	
	<p>A sore on the genitals.</p> 	<p>without itching or pain,</p> <p>with pain and pus.</p>	<p>syphilis venereal lymphogranuloma</p> <p>chancroid</p>	236
<p>a large, open sore or skin ulcer</p> 	<p>A large chronic (unhealing) sore surrounded by purplish skin—on or near the ankles of older people with varicose veins.</p> 	ulcers from bad circulation (possibly diabetes)	250	
	<p>Sores over the bones and joints of very sick persons who cannot get out of bed.</p> 	bed sores	251	
	<p>Sores with loss of feeling on the feet or hands. (They do not hurt even when pricked with a needle.)</p> 	leprosy	222	
	<p>A bump and then a sore that will not heal, anywhere on the body or face.</p> 	leishmaniasis	228	
<p>lumps under the skin</p> 	<p>A warm, painful swelling that eventually may break open and drain pus.</p> 	abscess or boil	239	
	<p>A warm, painful lump in the breast of a woman breast feeding.</p> 	mastitis (bacterial infection), possibly cancer	325	
	<p>A lump that keeps growing. Usually not painful at first.</p> 	cancer (also see lymph nodes)	326	
	<p>One or more round lumps on the head, neck, or upper body (or central body and thighs).</p> 	river blindness (also see lymph nodes)	225	

## SCABIES (SEVEN YEAR ITCH)

Scabies is especially common in children. It causes very itchy little bumps that can appear all over the body. Between the bumps are pin-head sized dark scabs.

### **They are most common:**

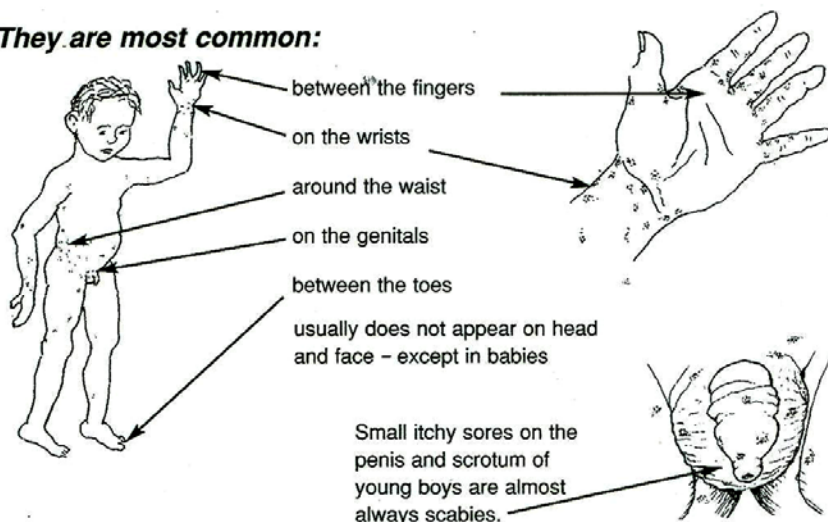

Scabies is caused by little animals—mites—which make tunnels under the skin. It is spread by close skin contact in the family, or by clothes and bedding. Scratching can cause infection, producing sores with pus, and sometimes swollen lymph nodes or fever.

Studies of students in rural Wellega, Gojam, Gondar, and Kefa found that 19–52% had scabies.

### **Treatment:**

- ◆ If one person has scabies, everyone in the family should be treated.
- ◆ Personal cleanliness is of first importance. Bathe and change clothes daily.
- ◆ Wash all clothes and bedding and hang them in the sun.
- ◆ Cut fingernails very short to reduce spreading and infection.
- ◆ Wash the whole body vigorously with soap and warm water.
- ◆ Apply benzyl benzoate lotion (p.425) on the whole body except the face. Allow the lotion to dry, and leave for 24 hours.
- ◆ Next day, wash and repeat the application for a further 24 hours.
- ◆ After treating, put on clean clothes and use clean bedding.

If benzyl benzoate is not available, the alternatives are:

- Lindane (p.425). Mix with body rubbing oil, 1 part in 15 parts of oil. Apply after washing, as above. Wash off thoroughly the next day. Repeat after 1 week. Lindane is more toxic and can cause poisoning. It should not be used for very young children, or for mothers who are pregnant or breast feeding.

## IMPETIGO

This is a bacterial infection that causes rapidly spreading sores with shiny, yellow crusts. It often occurs on children's faces, especially around the mouth. Impetigo can spread easily to other people from the sores or contaminated fingers.



### **Treatment:**

- ◆ Wash the affected part with soap and boiled water, gently soaking off the crusts.
- ◆ Paint the sores with gentian violet (p.423) or spread on an antibiotic cream such as **Polysporin** (p.423).
- ◆ If the infection is spread over a large area or causes fever, give penicillin tablets (see p.402), erythromycin (p.406) or co-trimoxazole (p.409).

### **Prevention:**

- ◆ Follow the guidelines of personal cleanliness (p.152). Bathe children daily and protect them from bedbugs and biting flies. If a child gets scabies, treat him as soon as possible.
- ◆ Do not let a child with impetigo sleep or play with other children. Begin treatment at the first sign.

## BOILS AND ABSCESSES

An **abscess** is an infection that forms a sac of pus under the skin. Sometimes it results from a puncture wound, or an injection given with a dirty needle. The area is swollen, hot, painful, throbbing and may appear reddish on light skin. Although the abscess may, after several days, break through the surface and release the pus, with relief of pain, much quicker relief can be had by having the abscess cut open, or aspirated through a wide bore needle. Get medical help if possible.



A **boil** is a localized abscess round the root of a hair. There is stinging local pain.

### **Treatment:**

- ◆ Put hot compresses over the boil several times a day (see instructions on p.232).
- ◆ Let the boil break open by itself. After it breaks, continue applying hot compresses. Allow the pus to drain, but never press or squeeze the boil, since this may cause the infection to spread to other parts of the body.
- ◆ If the infection from a boil or abscess does spread to cause swollen nodes or fever, take penicillin tablets (p.402) or erythromycin (p.406).

## CORNS

A corn is a hard, thick part of the skin. It forms where sandals or shoes push against the skin, or one toe presses against another. Corns can be very painful.

### **Treatment:**

- ◆ Get sandals or shoes that do not press on the corns.
- ◆ To make corns hurt less, do this:

1. Soak the foot in warm water for 15 minutes.



2. With a file or rasp, trim down the corn until it is thin.



3. Pad the foot around the corn so that it will not press against the shoe or another toe. Wrap the foot or toe in a soft cloth to make a thick pad and cut a hole around the corn.

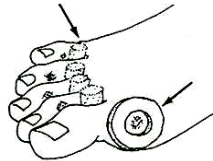

## AINHUM

This occurs mainly in farmers who walk barefoot. An abnormality of the blood supply to the small toes may lead to a gradually developing deformity. The toe becomes encircled by a band of scar tissue. Walking becomes very painful. After many months of pain the toe drops off. Both small toes may be affected. Medical help should be sought earlier for removal of the affected toe or toes. Immunization against tetanus is advisable first (p.170).



## KELOID

This is an overgrowth of scar tissue, and may occur when a wound has been chronically infected, e.g. after a girl's ear has been pierced for ear-rings, but without any aseptic precautions. The resulting keloid scar can be very disfiguring. If traditional healers attempt to remove the mass, it may result in an even bigger keloid. Get medical help, but be patient if a cure is not possible.

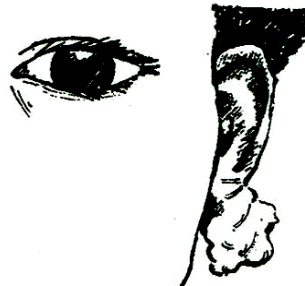

## 8-2. Answer for the pre test questions

### 8-2.1 answer for the Core module questions

- |      |       |
|------|-------|
| 1. E | 6. E  |
| 2. E | 7. B  |
| 3. C | 8. A  |
| 4. C | 9. B  |
| 5. E | 10. E |

### 8-2.2 Answer for the Health Officers Category

For answers on the health officer category please refer the respective satellite module for detail explanations.

### 8-2.3 Answer to pretest for Nurse Category

- |     |   |
|-----|---|
| 5.  | D |
| 6.  | E |
| 7.  | D |
| 8.  | D |
| 9.  | D |
| 10. | E |
| 11. | A |
| 12. | A |
| 13. | D |
| 14. | B |
| 15. | D |
| 16. | E |

## 8-2.4 Answers For the laboratory category

1. -Direct microscopy using KOH
  - Wood's light
  - Culture
2. -skin slit smear stained with Giemsa
  - Leishmanin test
3. Heating the KOH preparation facilitates the clearing process and enables the specimen to be examined immediately
4. B. True
5. C. A&B Amastigotes- in Microscopic exam  
Promastigotes- in culturing
6. B. False
7. A. True
8. D
9. D
10. D
11. E
12. D
13. D
14. A
15. B
16. . Antigen Capture EIA
  - . Immuno fluorescence
  - . Immuno filtration
  - . Detection for viral DNA or RNA
  - . Polymerase Chain Reaction



### 8.2.5 Answer Key for the Environmental Health category

1. C
2. D
3. A
4. B
5. E
6. FALSE
7. FALSE
8. FALSE
9. TRUE
10.
  - a. By causing direct contact non-allergic local tissue damage.
  - b. By causing allergic reactions to their secretions
  - c. By producing systemic toxicity
  - d. By transmitting diseases

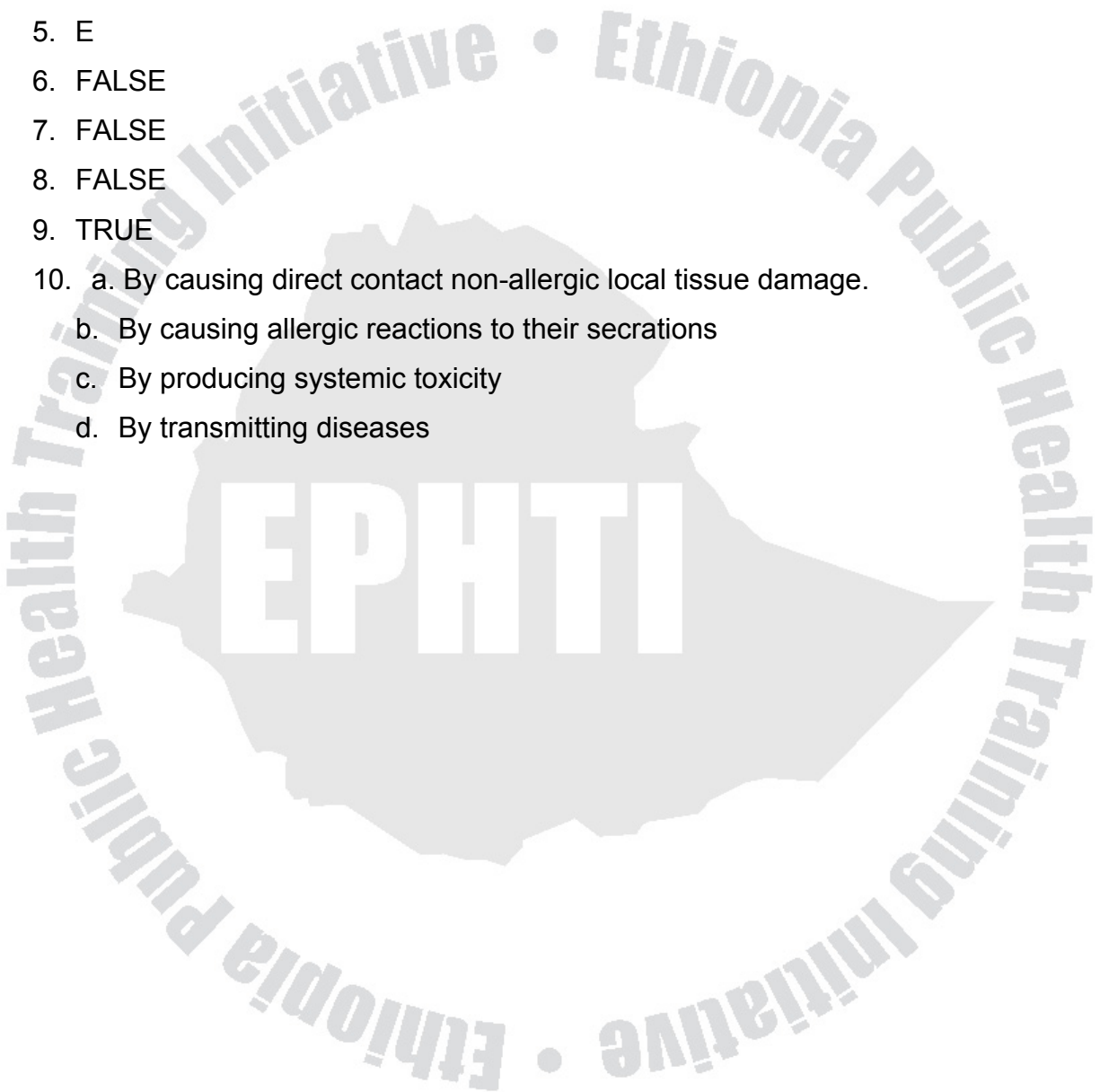

### 8.3. Bibliography

1. Thomas B. Color Atlas And Synopsis Of Clinical Dermatology; fourth edition; 2001
2. Barbara L. Atlas of African dermatology; 2002
3. Richard O. Barbara L. Differential diagnosis in dermatology; second edition; 1993
4. Irwin M. Freedberg, Arthur Z. Eisen, Klaus Wolff, K. Frank Austen, Lowell A. Goldsmith, Stephen Katz; Fitzpatrick's Dermatology in general medicine fifth edition; 1999
5. Rooks Text Book Of Dermatology R. H. Champion; D. S. Wilkinson; F. J. G. Ebling, Fifth Edition
6. Richard B. Odom, William D. James, Timothy G. Berger, Andrews' Diseases of the Skin: Clinical Dermatology Co; 9th edition (2000);
7. <http://www.emedicine.com/emerg/topic283.htm>
8. <http://www.emedicine.com/EMERG/topic88.htm>
9. AN OKORO pictorial Hand book of common skin diseases 1981.
10. J.S. PASRICHA. Treatment of skin diseases fourth edition oxford and I Butt publishing CO. PUT.CTO New Delhi Calcutta 2001.
11. Brunner- Textbook of medical surgical nursing T.B. Lippincott company sixth edition.
12. MOSCHELLA – Dermatology W.B. Saunders company PHILADELPHIA. Loson volume I 1975.
13. Kenneth A. Ayndt M.D. Manual of Dermatology therapeutics with essential of diagnosis second education 1978.
14. WATER F. LEVER, MD Histology of the skin, Patric et. Al's medical – surgical Nursing path physiological concepts Philadelphia, J.B. Lippincott company. 1991.
15. Hunter, savin, and dahi clinical dermatology voli1 and 2 oxford, black well scientific publication 1989.
16. Current medical diagnosis and treatment 35<sup>th</sup> edition a Lange Medical book 1996.
17. National technical guideline for integrated disease surveillance and response disease prevention and control department A.A. December 2002.
18. Wilfrid H.Parry Communicable disease 3<sup>rd</sup> edition London 1982.

19. Harrison principles of Internal Medicine 12<sup>th</sup> edition volume 1 New York 1991
20. Monica chesbrough, District laboratory practice in Tropical countries, part I, Cambridge university press, 1998.
21. E.Glyn V. Evans, James C.Gentles Essential of Medical mycology. 1<sup>st</sup> Ed, 1985, Churchill Livingston
22. Kenneth D. McClachey. Clinical Laboratory Medicine. Waverly Company, Williams & Wilkins, 1994.
23. Mackie and MacCartney . Practical Medical Microbiology. 14<sup>Th</sup> Ed. Harcourt Brace and Company Limited 1999.
24. OP Ghai, Piyush Gupta, Essential Preventive medicine, A clinical and Applied Orientation 2000 vikas publishing house, New Delhi.
25. E.H.O. Parry principles of Medicine in Africa 2<sup>nd</sup> ed. 1984, Oxford University press.
26. Mike W. Service, Medical entomology for students 2<sup>nd</sup> ed. 2000 Cambridge University press.
27. Cherop L. Teresa et.al. The effect of health education on prevalence of tinea capitis in children, Eldoret, Kenya, 1993.
28. Shibeshi et.al. Pattern of skin disease at the University teaching hospital, Addis Ababa, Ethiopia. In International Journal of Dermatology 39(11) Nov. 2000.
29. Y.Kabel Zhu. PhD, and Matthew J. Stiller, M.D. Arthropods and skin disease, International Journal of dermatology 2002, 45
30. Elaine Larson. Hygiene of the skin, when is clean too clean? Columbia University School of Nursing. New York, USA.
31. National institute of Arthritis and Musculoskeletal and skin diseases (2002). Handout on health: Atopic Dermatitis.
32. NCAA (2004). The physician and sports medicine: viral skin infections.
33. ILEP Technical bulletin: Issue No. 16, November 2003.
34. Mike W. service (2000) for students 2<sup>nd</sup> edition.

## 8.4. Authors Bibliography

1. Bishaw Deboch, BSc, MSc, Environmental Sanitation, Vice Dean, Public Health Faculty, Lecturer in the School of Environmental Health, Jimma University.
2. Zewdu Bezie, MD, Dermatologist, Assistant professor, Instructor, Medical Faculty Department of Dermatology, Jimma University
3. Dereje Ayele, BSc in public health, Asst. Lecturer, Head School of Health Officers.
4. Muluneh Haile, BSc, in Nursing, Asst. Lecturer, School of Nursing, Jimma University
5. Desta Workeneh, BSc, in Nursing, Asst. Lecturer, School of Nursing, Jimma University
6. Gebru Mulugeta, BSc, Medical Laboratory Technology, Asst. Lecturer, School of Medical Laboratory Technology, Jimma University
7. Getachew Belay, BSc, Medical Laboratory Technology, Asst. Lecturer, School of Medical Laboratory Technology, Jimma University
8. Adane Sewhunegn, BSc, Environmental Health Science, Asst. Lecturer, School of Environmental Health, Jimma University
9. Ahmed Mohammed, BSc, Environmental Health Science, Asst. Lecturer, School of Environmental Health, Jimma University